

**Archaeological excavation at
Handford House, 1 Queens Road,
Colchester, Essex
(now 'Handford Place')**

2003 and 2004-2005

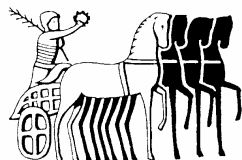
report prepared by Kate Orr

**on behalf of
Vaughan and Blyth (Builders) Ltd**



**with contributions from
S Anderson, S Benfield, J Bird, EW Black, H Brooks, HEM Cool,
N Crummy, J Curl, H Eckardt, V Fryer, H Martingell,
P Sealey, JP Wild, and P Wiltshire**

CAT project ref.: 03/1a
NGR: TL 9858 2475 (c)
Colchester Museums accession code: 2003.5



Colchester Archaeological Trust
Roman Circus House, Roman Circus Walk,
Colchester, Essex CO2 7HZ
tel.: (01206) 501785

CAT Report 323
May 2010, November 2021

Contents

1	Summary	1
2	Introduction	2
3	Archaeological background	2
4	Aim	3
5	Methodology	3
6	Results	3
7	Finds	5
	7.1 Roman pottery <i>by Stephen Benfield</i>	48
	7.2 Samian pottery <i>by Joanna Bird</i>	52
	7.3 Small finds and bulk metalwork <i>by N Crummy</i>	53
	7.4 Lamps <i>by Hella Eckhardt</i>	59
	7.5 Roman glass <i>by H E M Cool</i>	60
	7.6 Cremated human bone <i>by Sue Anderson</i>	64
	7.7 Inhumed human bone <i>by Sue Anderson</i>	75
	7.8 Animal bone <i>by Julie Curl</i>	79
	7.9 Charred plant macrofossils and other environmental remains <i>by Val Fryer</i>	81
	7.10 Pollen <i>by Patricia Wiltshire</i>	83
	7.11 Flint <i>by Hazel Martingell</i>	83
	7.12 Prehistoric pottery <i>by Paul R Sealey</i>	84
	7.13 Post-Roman pottery <i>by Howard Brooks</i>	84
	7.14 Roman brick and tile <i>by Ernest W Black</i>	84
	7.15 Clay pipe <i>by N Crummy</i>	85
	7.16 Textile <i>by J P Wild</i>	85
	7.17 The graffiti on the amphora from cremation burial F137 <i>by Ernest W Black</i>	86
	7.18 Miscellaneous finds	86
8	Discussion	87
9	Acknowledgements	96
10	Abbreviations and References	97
11	Glossary	103
12	Archive deposition	103
13	Appendices	103
	Appendix 1: Roman pottery catalogue and groups, <i>by Stephen Benfield</i>	105
	Appendix 2: tables of small finds and bulk metalwork <i>by N Crummy</i>	160
	Appendix 3: cremated bone tables and catalogue <i>by Sue Anderson</i>	164
	Appendix 4: catalogue of inhumed human bone <i>by Sue Anderson</i>	190
	Appendix 5: catalogue of animal bone <i>by Julie Curl</i>	195
	Appendix 6: tables of charred plant macrofossils and other environmental remains <i>by Val Fryer</i>	199
	Appendix 7: catalogues of medieval and post-medieval pottery <i>by Howard Brooks</i>	220
	Appendix 8: catalogue of Roman tile <i>by Ernest W Black</i>	223
	Appendix 9: catalogue of clay pipe <i>by N Crummy</i>	227
	Appendix 10: catalogue of miscellaneous finds	230

Figures - at end of report

EHF summary sheet

List of plates and figures

- Plate 1 (front cover) cremation burial F42 with lamp covered by pot sherd.
Plate 2 View of site during excavation, view north-east.
Plate 3 View of site during excavation, view west, towards 21 West Lodge Road.
Plate 4 *Bustum* F47, view east.
Plate 5 *Bustum* F134, with mirror and coin, view north-west.

- Plate 6 Cremation burial F53 with lamp, view north-north-west.
 Plate 7 Amphora cremation burial F137, view north-west.
 Plate 8 Inhumation burial F119, wearing shale armband, view north-east.
 Plate 9 Inhumation burial F171, wearing hobnailed shoes, view east.

- Fig 1 Site location.
 Fig 2 Map of Roman Colchester and site location.
 Fig 3 Plan of site, showing excavated areas and main features (burials, *busta* and road metalling toned).
 Fig 4 Plan of site, showing trench numbers, soakaway numbers and plot numbers.
 Fig 5 Plan of site, showing location of burials and *busta*, the footprint of the former Handford House, the three evaluation trenches and the areas of 19th-century disturbance (toned).
 Fig 6 Key to plans and sections.
 Fig 7 Inhumation burials plans and section: F1, F31, F40, F119, F154, F158-9, F171, and F208.
 Fig 8 *Bustum* F47: plan.
 Fig 9 *Bustum* F47: profiles.
 Fig 10 *Bustum* F134: plan.
 Fig 11 *Bustum* F134: profiles.
 Fig 12 F15: plan.
 Fig 13 F19: plan.
 Fig 14 F41: plan.
 Fig 15 F42: section and plans.
 Fig 16 F44: plan.
 Fig 17 F45: plan.
 Fig 18 F53: plans.
 Fig 19 F53: sections.
 Fig 20 F53: contents of spit 3 of urn.
 Fig 21 F53: contents of spit 4 of urn.
 Fig 22 F59: plan.
 Fig 23 F60: plan.
 Fig 24 F84: plan.
 Fig 25 F85: plan.
 Fig 26 F87: plan.
 Fig 27 F88: plan.
 Fig 28 F93: plan.
 Fig 29 F101/F107: plan.
 Fig 30 F102: plan.
 Fig 31 F108: section and plan, F103: plan.
 Fig 32 F113: plan.
 Fig 33 F114: section and plan.
 Fig 34 F115: section and plan.
 Fig 35 F118: plan.
 Fig 36 F120: plan.
 Fig 37 F123 and F130: sections and plan.
 Fig 38 F126: section and plan.
 Fig 39 F128: plan and contents of spits, 2, 5 and 8 of urn.
 Fig 40 F129: plan.
 Fig 41 F135: plan.
 Fig 42 F137: plan.
 Fig 43 F137: sections.
 Fig 44 F137: contents of amphora.
 Fig 45 F141: section, plan and contents of urn.
 Fig 46 F142: plan and contents of spit 6 of urn.
 Fig 47 F162: sections.
 Fig 48 F162: plan.
 Fig 49 F162: contents of urn.
 Fig 50 F165: sections and plan.
 Fig 51 F176: plan.
 Fig 52 F178: plan.
 Fig 53 F179: plan.

- Fig 54 F180: plan.
 Fig 55 F181: plan.
 Fig 56 F182: plan.
 Fig 57 F184: plan.
 Fig 58 F186: plan.
 Fig 59 F192: plan.
 Fig 60 F195: plan.
 Fig 61 F197: plan.
 Fig 62 F198: plan.
 Fig 63 F199: sections and plan.
 Fig 64 F200: plan.
 Fig 65 F201: plan.
 Fig 66 F203: plan.
 Fig 67 F204: plan.
 Fig 68 F209: contents of base of urn.
 Fig 69 F43 metalling: plan and section.
 Fig 70 F69 metalling with ditches F65 and F70: section.
 Fig 71 F117 metalling and ditch F127: section.
 Fig 72 F94 ditch with gully F95: section.
 Fig 73 F104 pit: section.
 Fig 74 F62 and F67 modern disturbance: section.
 Fig 75 F1, F31, F154, F208: pottery.
 Fig 76 F15, F19, F41, F42: pottery.
 Fig 77 F44, F45, F53, F59: pottery.
 Fig 78 F60, F87, F102: pottery.
 Fig 79 F103, F108, F113, F115: pottery.
 Fig 80 F118, F120, F128, F129: pottery.
 Fig 81 F135, F137: pottery.
 Fig 82 F141, F142, F162: pottery.
 Fig 83 F165, F178, F178, F179, F180: pottery.
 Fig 84 F181, F186, F192: pottery.
 Fig 85 F195, F198, F199: pottery.
 Fig 86 F200, F201, F204: pottery.
 Fig 87 F204, L3: pottery.
 Fig 88 F19.4 *aedicula*, F19.5 lamp fragment, F36.4 ring, F42.7 and F53.9 coin, F42.6 lamp.
 Fig 89 F42.8 hone, F45.3 bone bead, F53.8 lamp, F53.15 bone needle, F85.2 lamp
 Fig 90 F107.3 glass bead, F114.2, F114.3, F114.4 – iron chain links
 Fig 91 Box fittings: F120.1 inner and outer face of lock plate, lock bolt, stud through wooden board; F120.2, F120.3, F120.4 ring hinges.
 Fig 92 Box fittings: F120.5 hasp, F120.6 and F120.7 studs; box fittings: F126.2 nails with mineralised wood, F128.4 mirror.
 Fig 93 F128.5 lamp.
 Fig 94 F119.1 shale armllet; F134.4 copper-alloy spoon.
 Fig 95 F134.5 reflecting side of mirror.
 Fig 96 F134.5 rear side of mirror.
 Fig 97 F137.6 lamp, F141.2 lamp, F162.6 melon bead, F162.7 finger ring, F162.8 ivory armllet.
 Fig 98 F199.2 lamp.
 Fig 99 F199.3 picture lamp, F199.6 ring handle, F199.6 stud, F199.7 die, F200.2 mirror, F209.3 shale armllet, F209.4 melon bead.
 Fig 100 F96 swan's head terminal, F104 pottery counter, F152 finger ring, L1 pottery counter.
 Fig 101 F44, F98, F110, L2, F197, F198: photographs of coins.
 Fig 102 F42.11, F42.15, F42.16: glass unguent bottles; F42.17 glass Hofheim cup; F53.10, F53.11 conical glass flasks.
 Fig 103 F126.1 glass jar/urn; F53.12 conical glass flask; F142.5 glass unguent bottles.

1 Summary

Excavations were carried out in 2003-5 during the construction of a small housing development on the site of the demolished Handford House, 1 Queens Road, Colchester, Essex. The development site lies within an area of dense Roman burials located to the west of the town and to the south of the main road leading to London. Inhumation and cremation burials have been recorded previously in the vicinity. Following the evaluation in 2002, excavations at the Handford House site produced results which are augmenting and extending our knowledge of early Roman burial practices and beliefs.

The excavation revealed 68 burials in total, consisting of nine inhumation burials (excluding bone from three further inarticulated inhumations), two pyres and 57 cremation burials (seven of which did not contain cremated bone but have been classified as disturbed cremation burials). One possible pyre-debris deposit without cremated bone was also recorded. The two busta are the first of this type to be found in Colchester. The excavation consisted of the foundation trenches and service trenches which equated to approximately 10% of the 68m x 65m site. It is estimated that an open area excavation of the entire site would have exposed approximately 680 burials.

Of the 57 cremation burials, 35 were definitely urned, either in a ceramic or glass vessel or in a wooden jewellery box. At least three of the cremations burials contained pots which had been deliberately broken, post cremation, as did one bustum. In two examples, parts of broken pots had been placed to cover lamps, which is good evidence for the lamps having been lit before the graves were backfilled. Twenty of the cremation burials contained one or more ancillary vessels alongside the urn/box, for example, dishes, flagons and small beakers. These may have held food and drink. Between 11 and 15 cremation burials contained deliberately-deposited pyre debris in the pit fill. The debris consisted of small fragments of cremated bone, charcoal and artefacts such as melted glass phials, burnt pottery, nails from wooden boxes, lamps, coins, jewellery, a bone needle, a bone die and hobnails. This material was burnt with the body on the pyre and deliberately placed with the cremated human remains.

One of the urned cremation burials was deposited in a large Dressel 20 amphora. Subsequent excavation of its contents revealed a flagon, the neck of the amphora, the cremation urn, a lamp and a dish. Another cremation burial featured a large but broken Brockley Hill amphora which may have contained the cremation urn.

Several cremation and inhumation burials and one bustum produced butchered animal bone and fish bones suggestive of grave goods or the remains of graveside feasting. A Roman rubbish-pit containing butchered animal bones may also represent the remains of graveside feasting.

The environmental report shows little or no evidence for the deliberate deposition of plant materials on the pyre as offerings to the deceased. Although wood probably formed the main component of the pyres, subsidiary fuels almost certainly included gorse, bean 'straw', broom, bracken, dried grasses and grassland herbs.

The limited excavation did not show any particular groupings to the cremation burials except a general thinning out in the north-western corner.

The earliest cremations are mid 1st to 2nd century in date and some are definitely pre-Boudican. The cremation cemetery appears to have been in continuous use till the 3rd or 4th century.

The southern side of the site featured areas of metalling which may be a Roman road or trackway aligned east to west. The nature of the excavation made it difficult to ascertain whether it was a continuous cambered trackway, a hollow way or several discrete gravelled areas.

Nine adult inhumations (graves) were excavated, all of which were in the northern part of the site. No two burials were the same; the bodies were buried in different positions and on different alignments, and only two bodies had been definitely placed in coffins. One body (male) had been buried wearing a shale armet. Another (male) was buried wearing hobnail boots. Apart from being Roman, there is no conclusive dating evidence from most of the inhumations except for three which contained pottery dating them to some time between the mid 2nd to 4th centuries. Two inhumations did contain 1st- to 2nd-century pottery, but this may derive from earlier cremation burials. The shale armet may either be Late Iron Age/early Roman or late Roman. Therefore it is not possible to say whether the two burial practices of cremation and inhumation were being carried out concurrently or whether all the inhumations post-date the cremations.

Study of the human bone shows that those interred had a normal range of pathologies and injuries and there was nothing unusual in their stature, mortality rates or ratios of male to female. Study of the teeth showed that their diet was rich in carbohydrates which was normal for the Roman period.

The evidence from the glass vessels, small finds, the iconography on the lamps and coins, and the methods of cremation suggests that, in its earliest phases, the burial ground was closely associated with the inhabitants of the Roman colony with their wholly Romanised life-style, rather than the Romano-British (native) population living in the surrounding area. Busta are often associated with military centres and it is a burial rite which is likely to have been brought over from the continent

Burial in the cemetery ceased before the end of the Roman period when the site was used as a source for gravel. There was very little evidence of activity on the site from later periods. In the 19th century, various large trenches up to 1 m deep were dug which removed some of the cremation burials and disturbed several inhumation burials. It is possible that these are the excavations of antiquarian George Joslin who lived opposite Handford House.

2 Introduction (Figs 1-5)

- 2.1** This is the archive report on an archaeological excavation on the site of the former Handford House (now 'Handford Place'), 1 Queens Road, Colchester, Essex. The work was carried out by the Colchester Archaeological Trust (CAT) between the 20th February 2003 and the 12th January 2005 and it was necessitated by a planning application (no F/COL/02/1330) to demolish Handford House and erect twelve apartments and four semi-detached houses (plots 1-16) on the site. The main part of the excavation was carried out between February and June 2003 while foundations and service-trenches were being dug. Subsequent excavations were carried out as and when soakaways and other trenches were dug, between July 2003 and January 2005. The work was funded by Vaughan & Blyth (Construction) Ltd.
- 2.2** This report follows a Written Scheme of Investigation (WSI) prepared by CAT and approved by the Colchester Borough Council Archaeology Officer (CBCAO).
- 2.3** The 68m x 65m site is located at the corner of Beverley Road and Queens Road. It lies approximately 1km west of the town centre, south of Lexden Road, at National Grid Reference TL 9858 2475 (c).
- 2.4** The site was formerly occupied by 'Handford House' and its garden. This Victorian property was most recently used as an old people's home but suffered serious fire damage in 2001. The site is fairly level, lying at approximately 36m OD, and is surrounded by a hedge with trees. The drift geology is glacial sands and gravels.
- 2.5** This report follows the standards set out in Colchester Borough Council's *Guidelines on standards and practices for archaeological fieldwork in the Borough of Colchester* (CM 2002) and *Guidelines on the preparation and transfer of archaeological archives to Colchester Museums* (CM 2003), the Institute for Archaeologists' *Standard and guidance for an archaeological excavation* (IfA 1995) and *Standard and guidance for the collection, documentation, conservation and research of archaeological materials* (IfA 2001). The guidance contained in the documents *Management of archaeological projects* (MAP 2), *Research and archaeology: a framework for the Eastern Counties 1. Resource assessment* (EAA 3), *Research and archaeology: a framework for the Eastern Counties 2. Research agenda and strategy* (EAA 8), and *Standards for field archaeology in the East of England* (EAA 14) was also followed.

3 Archaeological background (Fig 2)

- 3.1** The development site lies within what Hull termed the 'West Cemetery' (Hull 1958, 253-4). This slightly misleading term refers to an area to the west of the walled town which was largely occupied by Roman burial plots. Roman cemetery areas were in use over a long time span and included inhumation and cremation burials. Roman cemetery areas have been recorded to the south of the town stretching from The Avenue east to Butt Road and the Abbey Field. Large numbers of Roman burials were excavated in the 19th century, notably by George Joslin and John Taylor who amassed large collections of antiquities. Tile tombs, lead and stone coffins and other built tombs as well as ordinary urned cremations, have been found all the over the area, especially along the line of the main Roman road leading to the walled town of Colchester from London. A detailed description and discussion of Colchester's Roman cemeteries can be found in Hull 1958 and, more recently, *CAR 9*, pp 257-75.
- 3.2** Many Roman burials have been recorded from Beverley Road, including some spectacular and well-preserved funerary monuments (*CAR 9*, 259-60). Most of these were excavated by Joslin in the vicinity of his house at 10 Beverley Road (Urban Archaeological Database or UAD no 907). In 1866, he discovered the so-called 'child's grave' in the garden of 10 Beverley Road which is directly opposite

the development site. This contained an unusual collection of pipeclay figurines (UAD no 990, Essex Historic Environment Record or EHER no 11850). Joslin's other finds include the tombstone of the Roman centurion Facilis found in 1868 (UAD no 992, EHER no 11857). In the garden of 1 Queens Road itself, two Roman cremation burials and other remains have been recorded although their precise find spots may be erroneous (UAD nos 1001 and 1003). In September 2002, CAT undertook an evaluation by trial trenches at the Handford House site which produced one *in situ* cremation burial and other cremation burials, all disturbed by 19th-century trench-digging (CAT Report 210).

- 3.3** The Monson map of Colchester of 1848 shows the site as undeveloped. The plot of land was part of the Beverley Lodge estate and was a paddock up until 1859 when it was sold off and Gafwell House was built there (James Fawn pers comm). Beverley Road was built in c 1860. From that time, houses were built along it, as can be seen on the 1st edition Ordnance Survey map of 1876. Gafwell House later was re-named Handford House. There is no evidence of the site ever having been arable land, ie it was never ploughed.

4 Aim

The aim of the archaeological work was to 'preserve by record' those archaeological remains that would otherwise be destroyed by the development.

5 Methodology (Figs 3-4)

- 5.1** The excavation ran concurrently with the demolition of Handford House and the groundworks for the new development (Plates 2-3). The footings, service-trenches, soakaways and garden wall pads were excavated archaeologically. The topsoil was removed by a mechanical excavator with a toothless ditching bucket, under archaeological supervision control. Therefore 'ground-level' in this report refers to reduced ground-level. The rest of the material was then excavated by hand until archaeological horizons or natural layers were reached. Approximately 10% of the site was excavated. Foundation trenches and service trenches were 600mm wide.
- 5.2** Individual records of layers and features were entered on CAT pro-forma record sheets.
- 5.3** Plans of cremation and inhumations burials were made at a scale of 1:10. Plans of pyres and some cremation burials were made at 1:1. Plans of other features were made at 1:20 or 1:50 as appropriate. Section drawings of features and layers were made at a scale of 1:10.
- 5.4** Finds were registered on CAT record sheets and assigned find numbers and small finds numbers according to context. Finds were washed, marked and bagged according to context.
- 5.5** Colour photographs of the site and of features were taken with a digital camera and a slide camera.
- 5.6** Metal detecting was carried out on the spoil heaps and some trenches where accessible.
- 5.7** The following abbreviations are used throughout the report: F = feature, L= layer, T = trench, S = soakaway, SF = Small Find, find numbers are in brackets.



Plate 2: the site during excavation, view north-east (frame ref: 2448)



Plate 3: the site during excavation, view west, looking towards 21 West Lodge Road (frame ref: 2583)

6 Results

Roman features

Roman features were sealed by post-Roman and modern topsoil (L1 and L2). They were cut into a Roman horizon (L3, L9, L40, L42, L43, L46, L47) and/or the underlying natural sand and gravel (L4). The Roman horizon was a yellowish brown silty loam, with a variable stone content, being quite gravelly in places. This could be redeposited cover loam.

Burials (Figs 3 and 5, Graph 1)

In total, 68 burials were exposed, consisting of nine inhumation burials (excluding bone from three further inarticulated inhumations), 57 cremation burials including four double burials (50 of the cremation burials contained cremated bone and at least four may be pyre debris dumps), and two *busta*. One pyre debris dump without cremated bone was also recorded. The inhumation burials were all concentrated in the north/north-eastern part of the site and lay at between 0.63m and 1.1m below ground-level. Two of the inhumations were interred in coffins. Cremation burials were scattered fairly uniformly throughout the site at between 0.3m and 1m below ground-level, but generally at a shallower depth than the inhumation burials. Disturbance had been caused by what may have been 19th-century archaeological excavations, which must have removed many more cremation burials but had largely left the more deeply buried inhumation burials *in situ*. There would also have been some disturbance to burials caused by the excavation and construction of the cellar to Handford House in the centre of the site, and of the vinery in the garden.

Note: 'double' cremation burials are cremation burials with the remains of bones from two individuals mixed together (in this case within the same urn) as opposed to 'dual' cremation burials which are instances of individuals interred in separate urns within the same grave (Barber & Bowsher 2000, 109-110).

Inhumation burials

Note: inhumation burials were given grave numbers, ie Grave 1 - Grave 9. The full bone report for the inhumation burials can be found in section 7.7.

Inhumation burial F1 (Grave 1), T2 (Figs 7, 75)

A badly preserved skeleton of a young/middle-aged male lying in a supine position in a grave cut which was aligned north-east to south-west with the head to the north-east. The top of the grave cut was 1m below ground-level at 34.66m OD. All that remained was the skull (to the north-east), one arm bone and part of a leg. The lower half of the skeleton had been cut away by a modern pipe trench. There were nineteen coffin nails, indicating that the individual had been interred in a coffin. An almost complete flagon of 1st- to 2nd-century date was found 20cm above the skull. The pot possibly came from an earlier cremation burial which had been cut through by the inhumation. Alternatively the flagon could have been placed on top of the coffin, but in that case one would expect it to be found on the skull rather than 20cm above. There was no separate cut for the flagon. As well as the beaker, there were a few sherds of other Roman pottery, dating to the 1st-2nd/3rd century, including two burnt samian sherds. There was also a fragment of slag (finds no 30).

F1.1 (1), Fig 75, an almost complete flagon, although neck and top missing (broken by machining), in white/cream oxidised ware (Fabric DJ). 1st-2nd century.

F1.2 (various finds numbers) 19 iron coffin nails. Complete nails vary from 45 to 75 mm long, but, as coffin nails tend to be all much the same length and the majority of complete nails from this grave cluster between 65 and 75 mm, the smallest one may be residual (see Table 1 below).

Graph 1: showing levels above Ordnance Datum of the top and bottom of Roman burials and other features.

(Only the cremation burials where the height of the urn or the top of the cut is known, or can be estimated, are shown).

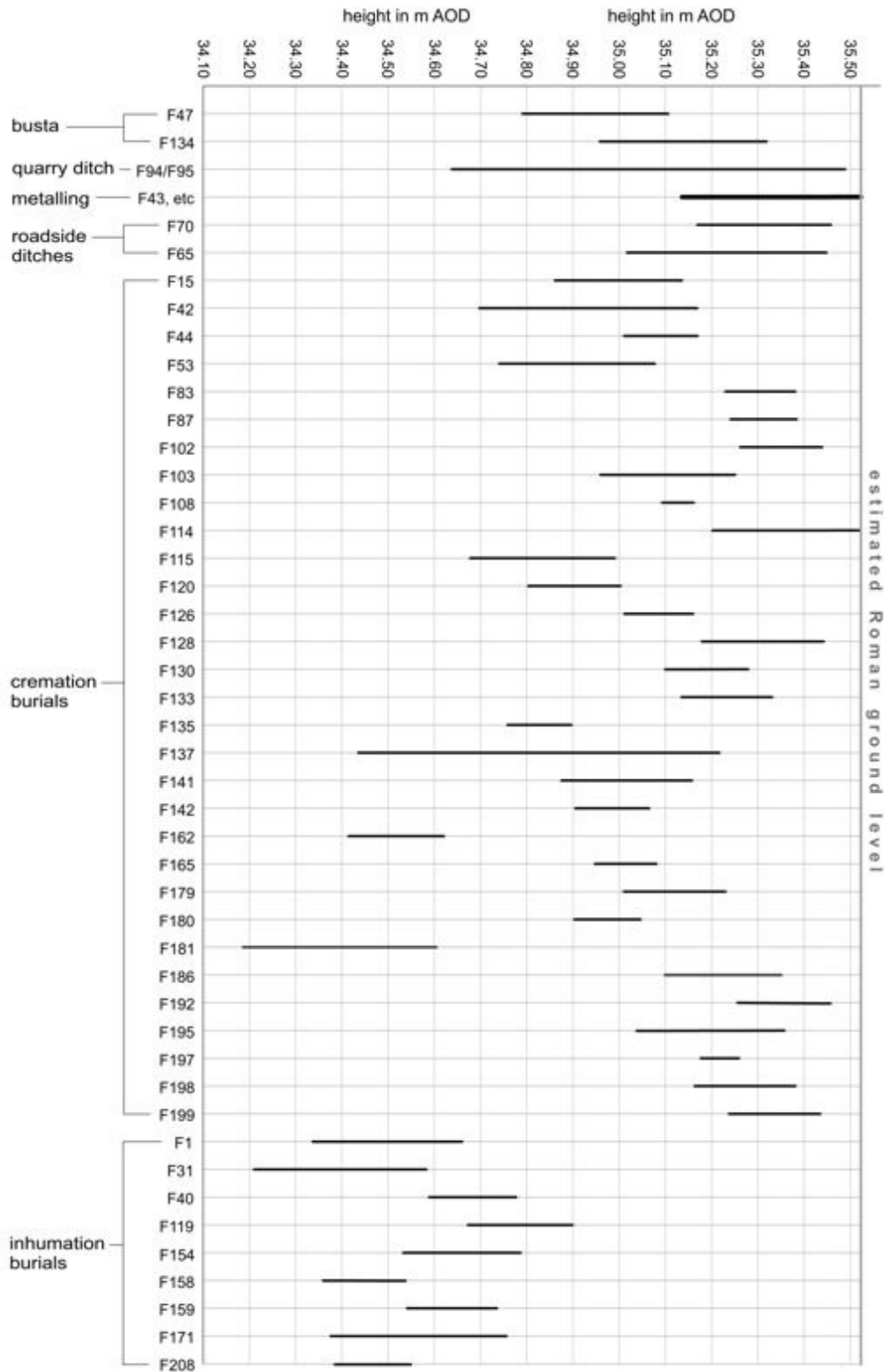


Table 1: iron coffin nails from F1, incomplete unless otherwise stated.

SF	Find	Description	Length
-	3	3, 1 complete but head damaged; 1 shank fragm	65, 45, 30; 21
-	13	1, complete	67
-	23	2, 1 complete	45, 10
-	24	2 nail heads	-
-	28	1	34
-	29	1	31
-	31	1, clenched; 1 shank fragment	36; 17
-	35	2 shank fragments	29, 41
-	36	1 shank fragment	38
-	37	1	26
180	38	1	31
-	39	1, complete	75
-	40	1, complete	70
-	41	1	32

Inhumation burial F31 (Grave 2), T8 (Figs 7, 75)

A skeleton of a middle-aged/old male lying in a flexed position on his side, in a pit with no evidence of a coffin. The grave was aligned roughly east-west with the head end to the south-west. The top of the grave pit was 1m below ground-level at 34.58m OD. The grave had been cut by a post-medieval pit (F39). The only articulated parts of the skeleton to survive were the right leg and foot. The leg was to the north-east. Skull fragments and fragments of all major limb bones and pelvis were present in F39, and almost definitely derive from F31. Other parts of the skull were found in a nearby modern feature (F8). The individual's remains show signs of osteophytosis, osteoarthritis, Schmorl's nodes and tuberculosis. The skull was very thick. Cranial anomalies indicate a relationship to the individual buried in F154. The grave and F39 contained fragments of butchered mammal bone, possibly cattle, none of which appeared to be burnt (finds nos 108, 105, 113, 120). Three nails and three hobnails may be residual from disturbed cremations (F31.1). Dating evidence from F31 comes from sherds of early 2nd- to 3rd-century or later pottery (Fabric GB). However, late 3rd- to 4th-century pottery (Fabric CH) found in F39 probably derive from F31. A possible Roman pottery counter (SF 12 (127)) was found in F39 but probably derived from F31.

F31.1 (83,109,110,111), 3 iron nails and 3 hobnails, maximum length 60mm

F31.2 (84, 105, 107, 119, 121), fig 75, fragments of Roman pottery in F31 and F39:

4 rim sherds of BB1: black-burnished ware category 1 (Fabric GA) Cam 279c (fig 75); 3 sherds Fabric GX (Cam 268 & Cam 280/281); 1 sherd Fabric HZ; 1 sherd Fabric WA; 1 sherd Fabric GB (Cam 40B); 1 sherd Fabric KX (Cam 37/38); 1 sherd Fabric CH; sherds Fabric UR *terra nigra* platter; 1 sherd of samian Fabric BA (Drag 45 mortarium); 1 sherd Fabric TY (TE) Nene Valley mortarium; sherds of Fabric EA Nene Valley colour-coat; sherd of Fabric CZ, early-mid 3rd-4th century, possibly late 3rd-4th.

Inhumation burial F40 (Grave 3), T7/T8 (Fig 7)

The skeleton of an adult, possibly a female, lay in a supine position in a possible grave cut. The grave was 1m below ground-level at 34.64m OD. It was aligned north-east to south-west with the head end to the south. The upper and lower body had been truncated by modern features. Fragments of pelvis, both upper leg bones and a few finger bones survived. The legs were to the north. Two fragments of Roman grey ware pottery (Fabric GX) came from the grave fill. No coffin nails were retrieved.

Inhumation burial F119 (Grave 4), T21 (Fig 94 and Plate 4)

A fairly complete skeleton of a young/middle-aged male lay in a supine position, aligned north-east to south-west with the head to the north-east. The individual was wearing a shale armlet on the left arm at the time of burial. The left foot showed a crush fracture and there was also evidence of a possible fracture to lower right leg, osteoarthritis and some cranial anomalies. The skull and top vertebrae were slightly higher up than the rest of the body, suggesting that the body may have been placed in the pit without a coffin. The top of the pit was 630mm below ground-level at 35.15m OD. There were three iron nails with tips or heads missing, all probably

residual. Two unidentifiable mammal bones were present within the fill. No pottery was retrieved from the burial.

F119.1 (642), SF94, Fig 94, a large plain oval shale armband of more or less D-shaped section. Minimum internal diameter 75 mm, maximum 84 mm; thickness 8 mm, height 14 mm. The shale armband was worn on the left upper humerus of the young/middle-aged adult male in this burial. Shale armbands first occur in the Bronze Age, but the first main phase of exploitation of the Kimmeridge shale beds dates to the Early Iron Age and the second to the Late Iron Age and Roman periods. The latter is so broad a time-span that dating individual plain armbands is rarely possible, and no successful dated typology has yet been established (Lawson 1976, 242, 248). However, in general, Roman armbands tend to be smaller, both in diameter and section, than their Iron Age predecessors, and, at an average diameter of about 60 mm, were a suitable size for slipping over the hand and wearing on the wrist and forearm (Wheeler 1943, 311; Lawson 1976, 248). They were usually, though not exclusively, worn by women (Cool 2002, 41). Though a few large diameter armbands have been recovered from Roman contexts in Britain, the practice of wearing an armband on the upper arm is generally a male characteristic, particularly in the Late Iron Age, when large-diameter arm-rings occur in male graves and small-diameter armbands in female graves; a local example is that of the warrior burial at the Stanway Quarry site, Colchester which contained a copper-alloy arm-ring 87 mm in diameter (eg Bellows 1881, 137-41, fig 9; Hawkes & Dunning 1930, fig 31, 2; Lawson 1976, 250 no 19; Crummy *et al* forth). While inhumations are rare in south-east Britain at the end of the Late Iron Age and in the early Roman period, they do occasionally occur (for example, Dean & Hammerson 1980; Stead & Rigby 1989, 81), and the possibility should therefore be considered that this inhumation dates to the immediately post-conquest period. A later date cannot, however, be excluded, as a late 3rd- to 4th-century male from London was buried with a decorated shale armband 82 mm in diameter beneath, but not on his left arm (Barber & Bowsher 2000, 221-2, B673.4).

F119.2 (no finds nos), 2 identifiable mammal bones, 7g.

F119.3 (660, 672-3), 3 iron nails, residual.



Plate 4: inhumation burial F119, with a shale armlet worn by the deceased at burial, view north-east (frame ref: 2382).

Inhumation burial F154 (Grave 5), T61 (Figs 7, 75)

A fragmentary skeleton of a middle-aged/old individual, probably a male, lay flexed on its side. Most of the skull was missing but some was found in the modern feature which had cut the burial (F155). The grave was aligned north-south with the head was to the north-north-west. There was evidence of Schmorl's nodes and osteophytosis on the spine. The skull was very thick like the individual's skull in F1. Osteoarthritis was in evidence on the lower arm and wrist.

The body had been placed a pit without a coffin. The top of the surviving grave cut was 850 mm below ground-level at 34.84m OD. The pit seemed to be deliberately shaped in order to place the body in a sleeping position. A large sherd of a 1st- to early 2nd-century small jar lay behind the vertebrae. The unlikely position of the jar suggests that it is residual within the fill rather than a grave good. Possibly it derives from a cremation burial which may have been cut through by the inhumation.

F154.1 (792, 842), Fig 75, an incomplete small jar, Cam 266 (Fabric GX), 1st-early 2nd century.

Inhumation burial F158 (Grave 6), T60 (Fig 7)

A few fragmentary adult foot bones were observed in a cut in the side of the service-trench. The bones of the right lower leg were seen in section. The foot end of the burial was to the south-east. The rest of the grave was under the boundary wall and it was decided not to excavate it. No nails or grave goods were retrieved. The top of the cut was 1.15 m below ground-level at 34.54 m OD.

Inhumation burial F159 (Grave 7), T63 (Fig 7)

Fragments of skull of a young person, unsexed, were found. The rest of the skeleton did not survive. The body was placed in a rectangular grave cut containing at least 14 coffin nails, mainly located at what was the feet end, and therefore the individual had probably been placed in a coffin. The top of the grave cut was 1 m below ground-level at 34.74 m OD. The grave was aligned roughly east-west, with the head to the east-north-east. There was one sherd of oxidised white/cream ware (Fabric DJ), and 1 sherd of Nene Valley colour-coat pottery (Fabric EA), both dated mid 3rd-4th century, from the fill (F159.2).

F159.1 (various find numbers) 14 iron coffin nails, maximum length 45mm (see Table 2 below).

F159.2 (858), 1 sherd of oxidised white/cream ware (Fabric DJ) and 1 sherd of Nene Valley colour-coat pottery (Fabric EA), both dated mid 3rd-4th century, 5g.

Table 2: coffin nails from F159. (All surviving heads are flat and round, and some are quite thick).

Find	Description	Length (mm)
856	1 shank fragment	13
857	1 shank fragment, slightly bent	43
866	1, incomplete	29
867	1, incomplete	26
868	1, complete, in 2 pieces	45
869	1, incomplete, in 2 pieces	32
870	2 shank fragments	38, 39
873	1 shank fragment	20
874	1 shank fragment	21
875	1, incomplete; 1 shank fragment	14, 17
876	1, complete	34
879	1, incomplete	23
882	1, incomplete	35

Inhumation burial F171 (Grave 8), T62/T66 (Fig 7, Plate 5)

The grave contained the almost complete skeleton of a male aged 25-30 years. The head was missing, but parts of a skull and lower mandible were found in the fill of a modern trench above

F171 (L36), which probably derive from this inhumation. There was no evidence of decapitation. The grave was aligned east-west, with the head end to the west. The individual was buried wearing hobnailed shoes which were still clearly visible as the oxides from the nails had leached into the surrounding soil and hardened it. Both tibia were slightly bent. There were two structural nails on the ribs which are probably residual. The cut is rectangular and wide and the base of the cut was not completely flat, both of which details, with the lack of coffin nails, indicate that the person was not buried in a coffin. One fragment of femur from a juvenile horse had been placed with the body, but it broke in two on excavation. This bone bore a chop mark on the shaft which suggests that the animal may have been used for food. No pottery was retrieved from the grave. The top of the cut was 1 m below ground-level at 34.76m OD.

F171.1, (897), SF 110, plate 9, hobnails from nailed footwear. The average length of loose nails was 13 mm. Iron hobnails from footwear were recovered from each foot. Both groups were distorted but enough of the original layout remained to show that they conformed to Rhodes' type C nailing pattern, with a line of nails around the outside edge and further lines filling in the central area (Rhodes 1980, 107). A minimum of 80 hobnails were on each shoe.

F171.2 (919), two juvenile horse femur bones, the larger one had been chopped.

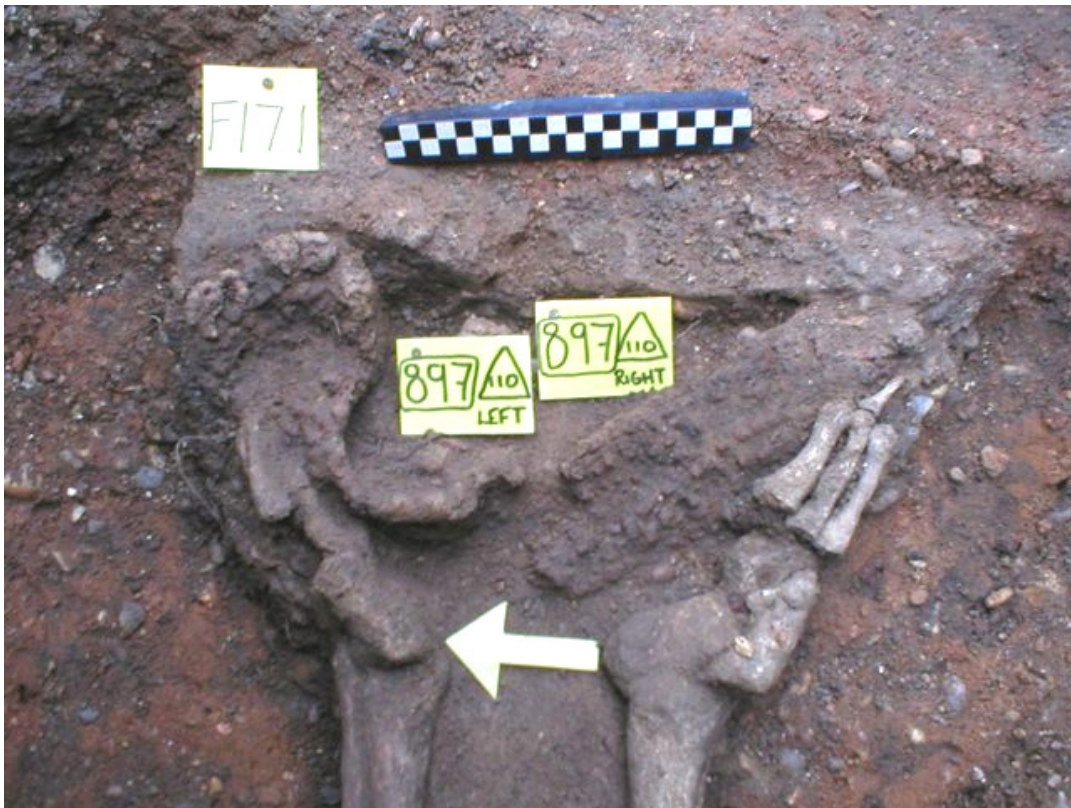


Plate 5: inhumation burial F171, with hobnailed shoes worn by the deceased at burial, view east.

Inhumation burial F208 (Grave 9), T120 (Figs 7, 75)

The jumbled remains of a middle-aged/old individual, probably female, lay in a barely distinguishable cut, the top of which was 1 m below ground-level at 34.48 m OD?. Mixed in with the human bone was animal bone and fragments of a nearly complete but broken grey ware jar, plus one iron object. The skeleton was fragmentary and consisted of parts of the skull, the mandible, lower halves of both humeri, upper right ulna, lower right femur, upper left femur and shaft, and fragments of tibia shafts. The disturbance was likely to have been caused by the digging of 19th-century feature F151. It is unclear, however, how the bone became so jumbled up.

F208.1, (1191), Fig 75, near complete, though broken, grey ware jar Cam 268 (Fabric GX), mid 2nd-3rd/early 4th century.

F208.2, (1191), SF 279, iron object.

F208.3 (1191), one cattle metacarpal, chopped.

Remains of other possible inhumations

F46, T14

Fragments of a large adult pair of tibiae and fibula shafts – probably one individual – were found in this modern feature which is thought to be part of a 19th-century excavation trench.

L2/L3, T5

Fragments of distal right femur and proximal tibia, and fragment of pelvis were retrieved from this layer. The bones are from a young adult.

L20, T33

An abraded fragment of adult skull was found within a modern layer. It is probably male. L20 may be part of modern trench F64, which is thought to be part of a 19th-century excavation trench.

Busta

Bustum F47, T15 (Figs 8-9, Plate 6)

A pit, 2.1m long (1.8m long at the base of the pit) and 650-700mm wide (550-600mm wide at the base of the pit) and 250mm deep, showing reddish burning of the natural sand and gravel around the top edges. It was aligned north-west to south-east. The upper 200mm of fill consisted of a dark yellowish brown silty loam with common burnt flint and stone and small amounts of cremated bone, charcoal flecks and a scatter of iron nails. The lower 50mm of fill consisted of very blackened soil, with charcoal and this contained the main concentration of cremated bone. The bones were lying in roughly anatomical order with the head end to the south-east and a burnt coin near the head end which presumably had been placed in the mouth or on the eye of the deceased. The total weight of the cremated human bone was 1,368g, which is not enough bone to be considered complete (see Section 7.6). The bone indicates that the individual was a middle-aged male. All the bone was well preserved with no signs of abrasion. There were many large pieces, the maximum bone fragment size being 77mm. Some bone showed some degeneration and evidence of slight osteophytosis of the spine.

The rest of the bone (and the remains of the pyre) may have been removed by ground reduction in the past. This conclusion is supported by a nearby cremation burial (F45) which contains an urn, the base of which is 130mm higher than the top of the cut for F47, meaning that the cut for F47 must originally have been at least 150mm higher up (see Graph 1). One flint blade fragment which is Neolithic in date and two other flint fragments (see Section 7.11) were residual in this feature. Melted glass from a vessel that had been placed on the pyre was present in the fill. The coin was a scorched and illegible as of early Roman date. The only other copper-alloy items were five small amorphous scorched fragments.

The majority of the objects from F47 are iron nails, varying in length from 18 to 70 mm. Though the 18 mm-long example may be a hobnail, there are two others not much larger (21 mm, 25 mm) but which are too large for hobnails. There is a group ranging from 40 to 49 mm, but the majority are between 60 and 70 mm. Two of the shorter nails (finds number 1155) are corroded together at right angles as if they came from the corner of a box. Interestingly, most of the pottery fragments were unburnt. The pottery and coin from this *bustum* give a likely 2nd- to earlier 3rd-century date for this *bustum*.

F47.1 (209) SF32, coin, illegible as, scorched, mid 1st-early 2nd century.

F47.2 (244) SF 247, five small fragments of scorched copper-alloy, the largest 8.5 by 5.5 mm.

F47.3 (various finds numbers) 149 iron nails, most incomplete plus two corroded together (see Table 3 below).

F47.4 (514) 1 very small melted fragment of colourless glass, melted on the pyre.

F47.5 (204) a few sherds/fragments of 2nd- to earlier 3rd-century pottery. This consisted of: one sherd of samian, probably East Gaulish (Trier) samian (Fabric BA (EG)) of form Dragendorf 31 or 31R and dated later 2nd-earlier 3rd century; 1 sherd probably of black-burnished ware category 2 (BB2: Fabric GB) and of early 2nd- to mid-late 3rd-century date; and a small quantity of grey ware sherds (Fabric GX), two of which have been burnt or scorched.



Plate 6: *bustum* F47, view east

Table 3: nails and shank fragments from F47, incomplete unless stated otherwise.

SF	Find no	Description	Lengths (mm)
-	103	1, tip only missing	61
-	194	1, bent	32
-	195	1; 1 shank fragment	23; 20
-	196	1	24
-	203	1 shank fragment	38
211	205	4; 4 shank fragments	longest = 19
-	205	1; 4 shank fragments	40, 34, 31, 29, 15
-	219	1	46
-	227	1, complete	60
-	228	1; 1 shank tip (possibly together complete nail)	45, 19
-	229	1 shank fragment	21
-	230	1 shank fragment	24
261	244	2 shank fragments	7, 19
260	245	3; 12 shank fragments	21, 15, 14; longest fragment 25
263	246	2	14, 15
-	247	2, the smaller is complete	26, 19
259	248	2 shank fragments	14, 25
-	321	1	38
-	322	1, complete	60
-	323	1 shank fragment, bent	30 (approximately)
-	324	1, complete (?hobnail)	18
-	325	1 shank fragment, clenched	27
-	326	1, tip only missing	54
-	465	1, complete	62
-	466	1, complete	63
-	467	1, complete	45
-	468	1, complete	48

SF	Find no	Description	Lengths (mm)
-	469	1, complete	54
-	470	2, complete	64, 56
-	471	1, complete	55
-	472	1, complete	65
-	475	1	43
-	476	1 shank fragment	36
-	480	1; 1 shank fragment	36; 43
-	481	2, complete, shanks crossed	60, 42
-	482	1, clenched	44 (clenched)
-	483	1, complete	17
-	484	1	31
-	485	1, complete, clenched	60
-	489	1	37
-	490	1, complete	59
-	492	1, complete	25
-	493	1, complete	51
-	494	1, complete, curved	55
-	499	1, complete	65
-	500	1, complete	70
-	501	1, tip only missing	45
-	502	1 shank fragment, clenched	40
-	503	1	39
-	504	1	47
-	505	1, complete, shank bent into hook	49 (bent)
-	506	1	36
-	507	1	28
169	508	1 shank fragment	17
-	509	1, complete, bent	40 (bent)
-	510	1	29
-	511	1	46
-	512	1	45
-	513	1	27
272	514	small flakes of iron only	-
-	514	3	41, 35, 33
271	515	1 + 2 heads; 7 shank fragments	13; longest shank fragment
-	515	2; 2 shank fragments	25, 20, 21, 20
203	516	2 shank fragments	14, 21
216	516	6; 12 shank fragments	longest = 29
270	517	2; 10 shank fragments	11, 18; longest shank fragment 30 mm.
-	521	1	37
-	523	1, complete, bent	43 (bent)
-	529	1	35
-	530	1; 1 shank fragment	29 (bent), 24
-	531	1, complete	21
-	532	1	30
-	1155	4 (two complete, two nearly so); 1 fragment. Two are corroded together at right angles, probably from the corner of a box; the tip of one is clenched, the tip of the other is missing	pair = 44 (clenched), 45; 53, 36

Bustum F134,T50 (Figs 10-11, 94-6, Plates 7a, 7b)

This was an oval pit 1.35m long (600mm long at base), 900mm wide (550mm at base) and 400mm deep. The natural sand and gravel around the top edges of the feature on the western, northern and north-eastern sides were burnt red. The upper 200mm of the fill was grey brown sandy loam with abundant burnt stone and a small amount of charcoal flecks and iron nails. The lower 200mm was very dark grey, almost black loam with common charcoal flecks, some small stones and hobnails. Most of the cremated bone was in this lower fill and concentrated to the south-western part of it. Also in this area was an unburnt smashed flagon within the upper fill, a copper-alloy coin of Domitian, a copper-alloy mirror and a copper-alloy spoon. The total weight of cremated human bone was 1818.4g which is enough bone to be considered complete.

The overall impression of the bone was that there was one individual (a probably middle-aged female) although some of the skull bone suggested a second (incomplete) individual, a male. The human bone specialist considers it to be an unusual form of unurned cremation burial; however, there was evidence of burning around the outside and the pit was deeper and larger than most cremation burial pits, suggesting that it had served as a vent under the pyre (although it was not as long as the body which had been burnt on the pyre). The jumbled nature of the bone indicates that, instead of the whole pyre collapsing into the pit and being left *in situ* (like F47), there was some pushing of the bone and pyre debris into the pit after cremation. 153g of cattle bone (metatarsals from a short-horned Dexter) and one fish vertebra were mixed with the cremated bone (F134.8).



Plate 7a: *bustum* F134, with mirror and coin of Domitian, view south-west

The mirror did not show signs of burning and therefore must have been placed in the pit after cremation. There was cremated bone below and above the mirror. The spoon and the smashed flagon had probably also been added after the cremation. The spoon was probably an item of female toilette. The coin showed evidence of burning and had been placed on the pyre (probably in the mouth or on one eye of the deceased). Animal bone (cow and fish) may be the remains of graveside feasting or food placed on the pyre or in the pit for the deceased. The other primary deposits consist of at least 46 hobnails from nailed footwear and a large quantity of structural nails. As in F47 and other burial features, the complete nails vary in size from 30 to 70 mm, with most at the upper end of the range. There was also a small quantity of other pottery sherds. This *bustum* dates from the late 1st (after AD 81) to the early 2nd century.



Plate 7b: *bustum* F134, with mirror and coin of Domitian, close-up view south-west

F134.1 (691, 692, 693, 813), SF 219, SF 220, SF 231 and SF 223a, at least 46 hobnails

F134.2 (various find numbers) 158 iron nails, mainly incomplete, maximum length 70mm (see Table 4 below).

F134.3 (804) SF 106, coin of Domitian, *as*, showing evidence of burning, burnt; reverse is emperor standing left, probably holding palladium on right hand, legend illegible. Date AD 81.

F134.4 (690), SF 95. Fig 94, copper-alloy spoon, in four fragments; the very tip of the handle is missing. The bowl is of the early Roman round form (*CAR* 2, 68, Type 1). Length 84 mm, bowl diameter 21 mm.

F134.5 (805), SF 107, Fig 95 and 96, handled speculum mirror of Lloyd-Morgan's group Gc (Lloyd-Morgan 1981, 37, 41-2), in fragments, dating to the second half of the 1st century. The reflecting side is decorated with groups of three small ring-and-dot motifs set at regular intervals around the edge. The rear face is very slightly concave and is covered with spin marks. It has bands of deeper turned concentric circles at the centre and towards the edge. The handle is of single loop form, with square terminal knob, side arms and pointed disc support. The rear face shows two points of attachment for the handle. A triangular scar from the support lies at a point where the edge is slightly flattened, and there is a second scar close to a lump of solder. The first is probably the original point of attachment, the second a repair. Diameter 115 mm, length of handle 107.5 mm.

F134.6 (679), fragments of a large ring-necked flagon, Cam 155. 1st to early-mid 2nd century.

F134.7 (813) small quantity of pottery sherds, mainly of buff oxidised ware (Fabric DJ) of which two or three are slightly greyish and may have been burnt, dated 1st-2nd century and possibly from a second flagon. Also sherds of grey ware (Fabric GX), Roman.

F134.8 (692 813), animal bone, mainly cattlr metatarsals, showing cut-marks and evidence of gnawing, 153g; also 1 fish vertebra.

Table 4: nails from F134, incomplete unless stated otherwise.

SF	Find	Description	Lengths (mm)
-	661	1	30
-	662	1 shank fragment	30
-	665	1	27
-	677	1, complete	30
-	678	1 shank fragment	34
-	682	1, complete	50
231b	691	14; 19 shank fragments, some possibly from hobnails	longest 21 mm; shank fragments range from 5 to 25
-	712	1	20
-	713	1 shank fragment	41
-	716	1, complete	51
-	720	1	28
-	726	1	27
-	782	1, complete	48
-	784	1	47
-	789	1, complete	70
-	797	1, complete, clenched	64
-	799	1	29
-	800	1 shank fragment	28
-	802	1	41
-	803	1	30
-	807	1, complete, bent	51 (bent)
-	808	1; 2 shank fragments	35; 16, 18
269	811	1 head; 4 shank fragments	-; 13, 15, 15, 18
223b	813	24; 57 shank fragments, some possibly from hobnails	range from 7 to 33; shank fragments range from 12 to 42
-	847	1; 4 shank fragments	21; 16, 22, 25, 26
-	1158	6; 5 shank fragments	14, 15, 33 (bent), 44, 57 (tip only missing), 86 (tip only missing) ; 10, 27, 33, 53 (bent), 61

Cremation burials (all urns contained cremated bone unless otherwise stated)

Urned cremation burial F15, T11 (Figs 12, 76)

An almost complete grey ware jar used as an urn placed had been placed in the centre of a small circular pit; the jar was slightly damaged during excavation. The jar has a distorted rim and is possibly a kiln waster or second. There was also an oxidised ware lid (F15.2) which had fallen into the urn. The weight of human bone in the urn was 1270.7g. The deceased was a middle-aged or old individual, probably male.

F15.1, (47) Fig 76, large storage jar, Cam 270B (Fabric GX), used as urn, 1st-2nd/3rd century.

F15.2, (1115, 1123) Fig 76, lid of *CAR 10* Type 163 (lid flat or domed with upward hooked rim) (Fabric DJ) used to cover urn, 1st-2nd century.

Cremation burial F19, T15 (Figs 13, 76, 88)

This was a cremation burial with pyre debris, badly truncated by gas-pipe trench F18 and with no cut definitely visible. Primary deposits, burnt on the pyre, were hobnails (F19.9), a melted glass unguent bottle (F19.10) and fragments of a picture lamp which showed signs of burning and which is pre-Flavian and probably pre-Boudican. There were fragments from three *tazza* (ceramic incense burners) from F18 and F19 (F19.1-3), showing signs of burning. It is not clear whether the *tazza* were burnt from being on the pyre or from burning incense, after the cremation. There were fragments of at least five other ceramic vessels (unburnt and probably broken prior to burial), including a flagon (F19.8), a Lyon ware cup (F19.6) and a grey ware jar (F19.7), but it is not clear which, if any, was the urn. The fill also included two fragments of a pipeclay base of an *aedicula* (the base of a statuette of a deity, probably included in the burial as a protective image: F19.4)). Three juvenile pig bones (F19.11) also came from the fill (see Appendix 5). Cremated bone was scattered and amounted to 379g. The bone is of an adult male. This cremation burial may have been unurned or urned, and its date, based on the lamp and *aedicula*, is AD 44-60/61.

- F19.1, (58, 67), Fig 76, *tazza* incense burner in fragments, Cam 198 (Fabric FJ), 1st to early 2nd century.
- F19.2, (54, 56), Fig 76, *tazza* in fragments, Cam 198 (Fabric FJ), 1st-early 2nd century.
- F19.3, (56, 67), Fig 76, fragments from *tazza* bowl base, Cam 198 (Fabric DJ), 1st-2nd century.
- F19.4, (71), SF 8, Fig 88, two fragments of a pipeclay *aedicula*, with traces of red paint on the outer faces of one piece.
- Front/side fragment, with flecks of red on the side and a red-painted stripe, defined by grooves, representing a column or pilaster on the front. The front is slightly recessed. The surfaces both appear to have an underlying wash of pale brown, though this may be discoloured by weathering. The inner surfaces are rough and finger-marked. Height 38.5 mm, width at front 22 mm, width at side 24 mm.
 - Front/side fragment, with traces of a pale brown wash. All the surfaces are smooth and intended to be visible, and one is slightly recessed.
- F19.5 (54, 65) SF7 and SF148, Fig 88, three fragments from the wall, shoulder and discus edge of a Lyon ware picture lamp, pre-Flavian and probably pre-Boudican. Very fine greenish-buff fabric with worn brownish-green slip; Further fragments of this lamp came from pipe trench F18, which cut through F19.
- F19.6 (54), SF148, fragments of a Lyon ware cup, Cam 62 (Fabric EB), pre-Flavian
- F19.7 (54, 58), fragments from a grey ware urn.
- F19.8 (54, 69, 67) fragments from a flagon(s) (possibly more than one pot represented) (Fabric DJ), 1st-2nd century (not illustrated).
- F19.9 SF 205. (68, 54, 55) Thirty-four hobnails or hobnail shanks. Thirteen iron hobnails and six hobnail fragments. Greatest length 23 mm.
- F19.10 (57, 66, 68) SF 160 and SF157 melted glass, one piece (66) from a tubular unguent bottle; blue/green; base fragment. Side curving into slightly flattened base. Surfaces slightly dulled; possibly heat affected. Present height 12mm.
- F19.11 (68), 3 juvenial pig bones, 4g.

Cremation burial F36, T13 (Fig 88)

Cremated bone and (possibly deliberately) smashed pottery lay in a pit. The burial was cut by modern pit F34. Both features contained 1st- to 2nd-century pottery including sherds of flagon (F36.1) and burnt samian (F36.2), as well as hobnails (F36.3) a heat-affected ring (F36.4) probably deriving from a jewellery box, and lump of melted glass (F36.5). There was 51g of cremated human bone (including that from F34) which derived from an adult, probably female. It is not known whether this was an urned or unurned cremation burial.

- F36.1 (93) sherds of a ring-necked flagon (Fabric DJ), 1st-2nd century.
- F36.2 (93) 1 sherd of South Gaulish samian dish, Dragendorf 15/17, 1st to 2nd century.
- F36.3 (93, 94), SF 204, six iron hobnails and six fragments. Average length 14 mm.
- F36.4 SF 246. (94), Fig 88, fragment of heat-affected ring of grooved section as SF 70 in F120. Rings of this type usually derive from jewellery boxes. Length 21 mm, section 3.5 mm in diameter.
- F36.5 (91), 1 lump of melted glass, probably from a tubular unguent bottle which melted on the pyre.

Urned cremation burial F41, Soakaway 2 (Figs 14, 76)

A flagon (F41.1) used as a cremation urn, with the neck and handle missing, lay on its side in a circular pit. There was a very small area of blackened soil on the north side of the flagon. A small amount of cremated bone came from inside the flagon and from the fill of the feature. The total weight of cremated human bone 166.8g. Four nails (F42.2) were present in the fill, and one of the nail may derive from a jewellery box. Thirteen hobnails were also present (F41.3). One small yellow/green unburnt glass body fragment of probable 1st- to 2nd-century date may be a chance inclusion in the pit fill. The bone appears to be from two individuals; an adult and a few fragments from a child aged 8-12 years, but the child's bones may be accidental inclusions from previous use of the pyre.

- F41.1 (128, 129, 140) Fig 76, flagon body and base of neck (Fabric DJ), which had been used as cremation urn, 1st-2nd century.
- F41.2 (128, 129, 140) SF206 and SF207, 3 structural iron nails, flat-headed, max length 23mm, plus 1 fragment of a nail head; 1 nail possibly from a box similar to the one in F120.
- F41.3 (129) SF 206, 8 hobnails.

F41.4 (129) 1 small yellow/green glass body fragment, unburnt, ?1st-2nd century.

Urned double cremation burial F42, Soakaway 1
(Figs 15, 76, 88-9, 102. Plate 1)

This was a circular pit containing a complete grey ware jar used as a cremation urn (F42.1), a smaller bowl (F42.2), complete but with part of rim missing, a complete flagon (F42.3), and one sherd of a large flagon (F42.4) covering the base of a beaker, on its side (F42.5). The pottery dates to the 1st to 2nd century; more specifically, some can be dated to the 1st to early 2nd century. The sherd of flagon F42.4 and the beaker had been carefully placed to cover a complete picture lamp (F42.6). The lamp is Central Gaulish, dating to the second half of the 1st century, probably pre-Boudican. The fact that the two pot sherds had been carefully arranged to create a cavity over the lamp strongly suggests that the lamp was lit before the pit was backfilled. The lamp design is of a lion attacking a crocodile and has funerary associations; the scene can be interpreted as the dangers of the afterlife (a crocodile) being warded off by an attacking lion. One half of an illegible copper-alloy ?1st-century coin came from near the centre of the pit. It provides a direct link to the adjacent cremation F53, which contained the matching half of the coin. The coin had not been burnt on the pyre but had been placed in the cremation pit with the lamp and the pottery vessels. A small fragment of a sandstone hone (F42.8) may be a deposit or residual.

Charcoally pyre debris with cremated bone had been placed next to the pots, to the south-west of them. Many hobnails (F42.9), structural nails (F42.10), and two small fragments of resolidified metal, probably lead (F42.18), plus one melted glass unguent bottle (F42.11) and other unrecognisable melted glass fragments (F42.12-14), lay within the pyre debris surrounding the pots. The main urn had not been placed on the bottom of the pit; a few centimetres of soil had been placed underneath it. There were fragments of unburnt mammal bone with the cremated bone on the eastern side of the pots.

The urn contained a glass cup (F42.17) and another tubular glass unguent bottle (F42.16); both complete and unburnt, as well as a melted tubular glass unguent bottle (F42.15). The cup is a 'Hofheim' type, a mid 1st-century form which was going out of use in the AD 70s. The distinct kick in the centre of the base might hint that it was in use during the later part of the life-span of the type; certainly this base form does not occur in the town-centre sites in Colchester in pre-Boudican contexts. The cup is the only certain example ever to have been recovered from a grave in Britain. The way in which glass drinking vessels are normally not normally represented in grave contexts suggests that the individual buried in F42 was of some special status. The cup was placed upright in the urn. The bottle was on its side. The lamp and the coin indicate a date of AD44-60-61, which also corresponds with the date of the tubular unguent bottle.

The urn (F42.1) was the only vessel found to contain cremated bone. The total amount of cremated human bone from the urn and pit fill was 370.7g. The bone comes from two children, one aged 5-6 and the other aged 12+.

The pit fill contained fragments of mammal bone, none of which appeared to be burnt. The lamp and coin indicate a date of AD 44-60/61 which also fits with the date of the tubular unguent bottle.

A connection has been suggested between F42, F44, F53 and F142 based on the use of gorse as a fuel (see section 7.9). The bone shows that all four individuals were under 18 years of age, but apart from that the bone does not show any relationship between the individuals. All four burials are dated to the mid or second half of the 1st century; however, F42 and F53, however, are linked by being adjacent and each containing one half of the same coin. This may well be evidence of a family relationship between the two.

F42.1 (136), Fig 76, grey ware jar, Cam 266 (Fabric GX) used as a cremation urn, 1st to early 2nd century.

F42.2 (153), Fig 76, small bowl Cam 221 (Fabric GX), complete but with part of the rim missing, 1st-early 2nd century.

F42.3 (137), Fig 76, ring-necked flagon, Cam 154/155 (Fabric DJ) Claudio-Neronian to early Antonine.

F42.4 (138) fragments of a large whiteware flagon (Fabric DJ), 1st-2nd century.

F42.5 (148), Fig 76 lower half of beaker, Cam 108 (Fabric GX), 1st-early 2nd century.

F42.6 (171) SF 26, Fig 88, a complete picture lamp of Loeschcke type IV (in Loeschcke 1919). The raised base is slightly uneven but otherwise this is a well-made lamp. The buff fabric is covered by a reddish-orange slip which has almost completely worn off on the top of the lamp. The wick hole shows no signs of burning but the lamp may have been deposited in the grave lit. The discus shows a lion attacking a crocodile, with both animals facing to the left. The only other example

known from Britain was found in London (Bailey 1988, 84, Q1518), but the design on the London example is much more blurred, while details of the bodies of both animals can be distinguished on the Colchester lamp. The lamp is central Gaulish; second half of the 1st century, probably pre-Boudican. Length 87 mm, width 60 mm, height 21 mm.

- F42.7 (177) SF 244, Fig 88, half a copper-alloy coin, an *as*, fits F53.9; obv and rev worn with no details of design visible; one side marked by heavy scoring, 1st century.
- F42.8 (283), SF177, Fig 89, small fragment of a sandstone hone, worn smooth on one face and the two long edges. The underside and short edges, though rough, are slightly abraded. Length 48.5, width 23 mm, thickness 8.5 mm. Possibly residual.
- F42.9 (various finds numbers and small find numbers) 65 hobnails.
- F42.10 (various find numbers) 11 or more structural nails.
- F42.11 (141), SF 13, Fig 102, 1 melted glass tubular unguent bottle; complete and now broken into two pieces. Out-turned rim edge, probably sheared; cylindrical neck; tubular reservoir. Heat affected and twisted. Length approx 66mm, rim diameter 15mm, maximum body diameter 17mm.
- F42.12 (147 and 177), SF 16, 1 melted blue/green glass lump and 4 melted blue/green glass fragments.
- F42.13 (136), 1 melted blue/green glass lump.
- F42.14 (132), 1 small blue/green glass body fragment not showing any sign of burning.
- F42.15, (1570), SF7, Fig 102, Tubular unguent bottle inside urn; blue/green; rim and neck fragment; now melted and flat. Out-bent rim, probably with sheared edge; cylindrical neck. Present height 29mm, rim diameter 17mm.
- F42.16, (1096), SF 129, Fig 102, a complete tubular glass unguent bottle inside urn; blue/green: complete. Outbent asymmetrical rim, edge sheared; tooled constriction with tubular reservoir; rounded base. Height 71mm, rim diameter 17 x 16mm, maximum body diameter 16mm. Dated no later than AD 75-85.
- F42.17 (1095), SF128, Fig 102, a glass Hofheim cup inside urn; blue/green; complete but cracked. Inbent rim, edge cracked off and ground; convex-curved body; small pointed kick in centre of base. Wide wheel-cut channel below rim with abraded band on either side; narrow abraded band on greatest circumference of lower body. Height 64mm, rim diameter 60mm, base diameter 28mm.
- F42.18 (136) 2 small fragments of resolidified metal, probably lead. 1g.

Urned cremation burial F44, T14 (Figs 16, 77, 101)

A complete but cracked grey ware bowl (F44.1) used as a cremation urn had been placed in the centre of a circular pit. Hobnails and nails and (F44.6 and F44.6), sherds of the base of a flagon (F44.3) and heat-dicoloured sherds from a probable flagon (F44.2) were all present within the pit fill. The urn and flagon/s are 1st-2nd century in date. The fill of the urn and the fill of the feature contained some cremated bone and there was some charcoal in the fill of the feature. A coin to the south of the urn dates from the reign of Titus, AD 79-81. The coin (F44.4) was unburnt and very little worn, giving a close date for this burial. The total amount of cremated human bone was 220.3g, which came from a young child.

- F44.1 (182) Fig 77, a complete grey ware bowl, Cam 218 (Fabric GX) used as an urn, 1st-early 2nd century.
- F44.2 (179) small quantity of base and body sherds probably from a flagon (Fabric DJ). Sherds may be partly heat discoloured. 1st-2nd century.
- F44.3 (181) small quantity of sherds from a ring-necked flagon, probably form Cam 154/155 (Fabric DJ), Claudio-Neronian.
- F44.4 (166), SF 23, Fig 101, coin, *as* of Titus, reverse *Spes*, AD 79-81.
- F44.5 (178, 182), SF210, at least 21 hobnails.
- F44.6 (180, 178), at least 1 nail.

Cremation burial F45, T17 (Figs 17, 77, 89)

Fragments of a flagon which was lying on its side (F45.1) within a barely discernable circular cut. The top of the flagon was only 300mm below ground-level. The flagon did not contain cremated bone and there was only a small amount of bone from the fill. The feature could either be an urned or unurned cremation burial. Two hobnails (F45.4), four very small amorphous slag-like fragments (F45.5), a fragment of unburnt Roman light green glass (F45.6; see section 7.5) and a fragment of a burnt bone bead (F45.3) were in the pit fill. There was a small patch of charcoal in the fill of the feature. The top of the feature had been truncated by post-medieval or modern activity, evidenced by post-medieval tile, clay pipe and coal. Three sherds of a Roman dish (F45.2) also came from the fill of the feature. The burnt bone bead and the glass body fragment were found in a soil sample. The total amount of cremated human bone was 4g.

- F45.1 (164), handle and base of a flagon (Fabric DJ), 1st-2nd century.
- F45.2 (165) Fig 77, 3 rim sherds of a dish, Cam 8 (Fabric UR), Claudio-Neronian.
- F45.3 (175), SF 287, Fig 89, burnt bone bead.
- F45.4 (175), SF264, 2 hobnails.
- F45.5 (175), 2 very small amorphous slag-like fragments.
- F45.6 (175), 1 body fragment of light green glass.

Urned cremation burial F53, Soakaway 1 (Figs 18-21, 77, 88-9, 102-3, Plate 8)

This was a circular pit next to F42 containing a complete jar used as a cremation urn (F53.1) and covered by a large body sherd of a Brockley Hill flagon serving as a lid (F53.2). Another sherd of the same flagon had been placed over the neck of the flagon which was standing upright, next to the urn. This flagon neck had been placed over the flame end of a picture lamp (F53.8), thereby creating a cavity to protect the flame similar to that in F42. The lamp depicted a stave dancer with a large phallus, an image which would have been chosen to protect the deceased person in the afterlife. The lamp dates to the second half of the 1st century and is probably pre-Boudican. To the north of the urn was a complete *terra nigra*-type dish (F53.3), on its side against the side of the pit.

The upper fill of the feature consisted of 200mm of greyish brown sandy silt (to just below the rim of the cremation urn). Underneath this was very charcoally pyre debris with frequent fragments of cremated bone. This continued to the base of the feature and contained burnt pot sherds (F53.4-7; some almost melted on the pyre), three copper-alloy pellets (F53.16), iron nails (F53.14) and hobnails (F53.17), vitrified clay (F53.18) and part of a bone needle (F53.15), the head of which was later found within the urn. Half a coin (F53.9, the other half to that found in F42) was mixed in with the pyre debris but was not burnt so probably was deposited as a grave good.

Inside the urn were three whole glass vessels (F53.10-12). All have elements which suggest they are of mid 1st-century date. A date in the decade before the Boudican uprising seems most appropriate for this grave, although some of the grave goods could equally date to the years immediately after that event. Further fragments of the Brockley Hill flagon were present inside the urn (F53.2) which had presumably fallen in (Figs 20-21).

The total amount of cremated human bone from the burial was 368g. The bones are those of a child aged probably between 3 and 5 years. The date of this burial is likely to be the second half of the 1st century.

- F53.1 (199), Fig 77, a complete jar, Cam 266, used as a cremation urn, pierced base (Fabric GX), 1st - early 2nd century.
- F53.2 (197,198, 200, 211, 1104, 1107-09), Fig 77, several large sherds from a collared flagon, including the neck, Brockley Hill, Cam 140 (Fabric FJ) Claudio-Neronian. Sherds found in the pit fill and inside the urn (F53.1); one sherd was used as a lid
- F53.3 (240), Fig 77, a complete *terra-nigra*-type dish with central stamp, Cam 16 (Fabric UR), 1st-early 2nd century.
- F53.4 (276, 280) Fig 77, burnt, almost melted grey ware jar sherds, Cam 266 (Fabric GX), 1st-early 2nd century.
- F53.5 (280) 2 sherds of a burnt ring-necked flagon, Cam 154 (Fabric DJ), Claudian
- F53.6 (215, 280) burnt sherds from a beaker, Cam 108 (Fabric GX), 1st-early 2nd century.
- F53.7 (208, 214, 224, 261, 267, 1122,1107,1108) small quantity of other sherds from fill of pit and inside the urn, some burnt, Fabrics DJ, GX, DZ & FJ. Sherds dated probably 1st-early 2nd century.
- F53.8 (201), SF 33, Fig 89, an almost complete picture lamp of Loeschcke type IV, with only the discus slightly damaged. The lamp has a base ring. It may have been deposited in the grave lit but the wick hole area shows no signs of burning but the lamp may have been deposited in the grave lit. The discus design depicts a grotesque stave dancer facing to the left. The ground is indicated by a horizontal line and the dancer holds staves in his raised left hand. The end of his right arm and part of his head are lost. The large phallus and short stature are typical of Roman grotesques. The closest parallel known comes from Glanum, near St-Rémy-de-Provence, France (Bémont 2002, 80, pl 15, 162). Only two other lamps with stave dancers are known from Britain (Eckardt 2002a, 376, nos 695 & 2319). The example from Oxford shows a stave dancer in a boat (Bailey 1980, Q1363) while the unpublished lamp from Silchester (2319) shows a taller figure walking right. Both these examples are, however, on Loeschcke type VIII lamps. Creamy-buff fabric with light brown slip, probably Central Gaulish; second half of the 1st century, probably pre-Boudican. Length 90 mm, width 62 mm, height 22 mm.

- F53.9 (277), SF38, Fig 88, half of a very worn and illegible, probably 1st-century copper-alloy coin. Heavy scoring on one face was probably made with a chisel in an effort to break the coin in half. The other half of the coin was found in the adjacent burial F42 (F42.7)
- F53.10 (1097) SF130, Fig 102, a complete conical glass flask inside urn; blue/green. Narrow triangular rim; cylindrical neck; slightly convex-curved conical body; flat base. Height 46mm, rim diameter 30mm, maximum body diameter 75mm, base diameter approx 35mm. Mid 1st-century date. The rim has a very small triangular profile. In the town-centre sites, nearly half of the flask rim fragments with this profile were found in pre-Boudican contexts (*CAR* 8, 164). It is the rim form found on two flasks from one of the cremation burials found at Sheepen, for which a Neronian date seems most likely (Charlesworth in Niblett 1985, Microfiche 1:A8 nos b and c). Both of the blue/green flasks in the famous figurine grave at Colchester also have this rim formation, though with slightly more bulbous bodies (Eckardt 1999, 74, fig 7 nos 37/1139 and 38/1140 – NB in neither case is the rim formation drawn accurately in these illustrations).
- F53.11 (1110), SF 132, Fig 102, a tall conical glass unguent bottle inside urn. Blue green. Rim broken off but otherwise complete. Outbent rim, edge sheared; cylindrical neck tooled at base; slightly expanding straight side; very shallow concave base. Height 146mm; rim diameter 28mm, maximum body diameter 44mm. It differs only from a tubular unguent bottle in that it has a flattened rather than rounded base. It would have been in use at the same time as the tubular form. A very similar one, for example, came from a mid 1st-century cremation burial at Little Alie Street, London (RCHME 1928, 159, fig 65 no 28). The tall conical form seems less common than the tubular one, but that may just be because of the larger capacity. A very similar example to this one has been found in Colchester before, presumably also from a grave, although it is now without provenance other than the fact that it formed part of the Joslin collection (Colchester Museums JOS 299). This one (F53.11) was found with the main part of the vessel in spit 4 and the rim in spit 7, suggesting the vessel was placed into the urn after it was broken. Presumably the contents were used during the interment ceremonies; possibly poured over the burnt bones.
- F53.12 (1102,1103), SF133, Fig 103, complete conical glass flask inside urn; blue/green; complete with one fragment of rim and neck detached. Narrow rim outbent horizontally and edge sheared; cylindrical neck; slightly convex-curved conical body; very slightly concave base. Height 95mm, rim diameter 21mm, maximum body diameter 49mm, base diameter approx 28mm. The rim on no 17 consists merely of a small horizontally out-turned edge. This was a very rare rim form amongst the material from the town-centre sites, and the only example was found in a context that dated from the mid 1st century to the early 3rd century (*CAR* 8, 163 no 1261). It was suggested it should be regarded as being a variant of the rim finish on tubular unguent bottle. The discovery of this flask in association with F53.11 and F53.10 (undoubted mid 1st-century flasks), shows that this is indeed the case.
- F53.13 (199) Melted blue/green glass fragment in spit 5 inside urn. Weight less than 1g.
- F53.14 (various find and small find numbers) 60 nails. Complete nails vary in length from 39-56mm but there is also a 65mm shank fragment from a much longer nail (see Table 5 below).
- F53.15 (199, 267) SF 285, SF286, Fig 89, shaft and head of a bone needle, probably part of the same object.
- F53.16 (224, 242, 268), SFs 36-7, 250, 3 copper-alloy pellets.
- F53.17 (various finds numbers and SF numbers), 15 hobnails.
- F53.18 (267), 6 small fragments of vitrified clay; 1 may be a vessel sherd, and one may be from a lamp, 1.3g.



Plate 8: cremation burial F53 with lamp, overhead view north-north-west

Table 5: iron nails from F53, incomplete unless otherwise stated.

SF	Find	Description	Length
-	202	1, clenched close to end	42
258	208	2 shank fragments	8, 14
-	212	1, tip only missing, clenched close to end	54
-	213	1, complete; 1 shank fragment	44; 18
213b	224	1; 15 shank fragments, some may be hobnails	19; range from 7 to 22
-	231	1, tip only missing	41
-	232	1, tip only missing	52
-	233	1 shank fragment, clenched	65
-	234	1	55
-	238	1, complete, clenched	39
-	239	1, bent	28
-	240	1 (also flakes of iron from environmental sampling)	27
-	241	1	21
-	243	1, complete	44
-	250	1, clenched	29
-	251	1	33
-	252	1, complete; 2 shank fragments; 1 nail head	39; 21, 26; -
-	255	1, complete	56
-	256	1, complete	53
-	257	1	28
-	258	1, complete	51
-	259	1, tip only missing, clenched near end	46
-	260	1	41

SF	Find	Description	Length
-	265	1, complete, clenched	37
-	266	1	30
214b	267	10 shank fragments, some may be hobnails	range from 7 to 26
-	269	1, tip only missing, clenched near end	31
-	274	1 shank fragment, bent	24
-	275	1, bent	30
-	278	1 shank fragment	32
266	279	1	8

Urned cremation burial F59, T23 (Figs 22, 78)

This feature consisted of a scatter of broken pottery of 1st- to 2nd-century date including a jar used as a cremation urn (F59.1), a lid (F59.4) and the base of a flagon (F59.2), plus cremated bone and hobnails. The cut was not visible. Later disturbance was evidenced by peg-tile at the same level as the bone. The total amount of cremated human bone was 247.4g which was from an adult male.

F59.1 (287), fragments of a grey ware jar which had been used as cremation urn (Fabric GX), 1st-2nd century.

F59.2 (288), Fig 77, fragments of the lower part of a flagon (Fabric DJ), 1st-2nd century.

F59.3 (287, 290), two hobnail fragments.

F59.4 (287), other sherds (all Fabric GX), including a ?lid, 1st-2nd century.

Cremation burial F60, T25 (Figs 23, 78)

This consisted of an almost complete jar or bowl (F60.1) possibly used as a cremation urn, the bottom three quarters complete and the rim in fragments, plus fragments of a plain beaker (F60.2), both 1st to early 2nd century. No cut was discernible and no cremated bone was observed, indicating that the pot had been displaced from its original position by some sort of ground movement. Post-medieval pottery, clay pipe and tile were found at the same level.

F60.1, (291), Fig 78, an almost complete jar or bowl (Fabric GX), possibly used as a cremation urn, 1st-2nd century.

F60.2, (291), fragments of a plain beaker, Cam 108 (Fabric GX), 1st-early 2nd century.

Cremation burial F83, T30/T35

Occasional fragments of Roman pottery (F83.1) plus one unidentified piece of tile and cremated bone in the fill of a circular feature. The total amount of cremated human bone was 11.6g. This is could be either an unurned cremation burial or a pyre debris deposit, but the lack of charcoal in the fill makes it more likely to be a cremation burial.

F83.1 (345), very small quantity of small fragments of grey ware (Fabric GX) and oxidised coarse pottery (Fabric DJ), 11.2g, 1st-2nd/3rd century

Cremation burial F84, T35 (Fig 24)

This burial, possibly unurned, consisted of a spread of cremated bone within topsoil L1 and subsoil L16, but with no cut discernible. The cremation burial appeared to have been disturbed, possibly by gardening. The total amount of bone was not recorded.

Cremation burial F85, T27 (Figs 25, 89)

A charcoally patch of uncertain edges, containing 27.1g cremated bone. The feature had been cut into by modern trench F91 and was heavily disturbed. There was no trace of an urn, suggesting an unurned burial, although there was a small quantity of sherds in the fill (F85.2). A few fragments of unidentified tile (one of which was burnt), and two fragments of tile *imbrices* were found within the charcoally patch. Fragments of a lamp (F85.1), probably of early 2nd-century AD date, give a date for this burial.

F85.1 (340), Fig 89, a lamp in fragments. This is a crudely-made lamp of unusual form, probably intended to imitate a factory lamp. It has a circular body with the beginnings of a shoulder ring and an applied handle with a central groove. The nozzle is very large but the diagnostic upper surface does not survive. Pinkish-grey fabric with frequent large inclusions, almost certainly a London product;

similar 'derived factory lamps' are known from London (Eckardt 2002a, 193-9). Probably of early 2nd-century AD date. Width 53 mm, height 23 mm.

F85.2 (341), small quantity grey ware (Fabric GX). This includes sherds from a bowl of form Cam 218, 1st-early 2nd century.

Urned cremation burial F87, T35 (Figs 26, 78)

A jar of black-burnished ware category 2 (BB2), which was used as a cremation urn (F87.1), was found in a circular pit, on its side. The jar was almost complete but the parts of the sides had previously broken off and were embedded in the fill of the pit. The rim was sliced off during hand-excavation. Cremated bone had spilled out of the urn where it was broken. The jar contained a small amount of cremated bone plus one *tazza* fragment (F87.3). There were two fragments of a cream-coloured pot (F87.2) to the north-east of the jar. The jar is probably dated early/mid 2nd to late 2nd/early 3rd century. The total amount of cremated human bone was 266.5g, and it comes from an unsexed adult.

F87.1 (394, 431), Fig 78, an almost complete Cam 278 jar in black-burnished ware category 2 (BB2) (Fabric GB), early 2nd to early 3rd century, used as a cremation urn. The jar would have been originally decorated with a burnished lattice or vertical stripe/line pattern, but no trace of this pattern now remains. The pot is discoloured (reddened) by heat on one side, and was either burnt or scorched before breakage, or is a kiln second.

F87.2 (419), 2 fragments of a cream-coloured pot, Fabric DJ, ?1st century.

F87.3 (431), 1 fragments of a *tazza* (Cam 198) within urn, 1st-2nd century

Cremation burial F88, T37 (Fig 27)

This burial consisted of a scatter of pottery from at least five different vessels including two different amphorae, a flagon and a grey ware jar. There was no sign of a cut. The sherds came from L23 and had been displaced from their original position. Some pot sherds were upright. 8g of cremated bone came from the surrounding L23 (find no 377). The pottery is mainly dated to 1st-2nd century, although interestingly there are sherds from a mid-late 3rd- 4th-century pot. The feature had been disturbed, perhaps as a result of modern gardening.

F88 (381, 378 and 382) fragments of a flagon in white ware (Fabric DJ), 1st-2nd century.

F88 (382, 380, 381) amphora body sherds; (380 = AJ amphora, Dressel 2-4? 381 = AA amphora), 1st-early 2nd century.

F88 (382) sherds from a jar, Cam 279C, black-burnished ware category 1 (BB1) (Fabric GA), early 3rd-4th century.

F88 (382 and 378) grey ware sherds (Fabric GX), Roman.

F88 (378) Lyons ware cup or beaker (Fabric EB), pre-Flavian.

Cremation burial F93, T36/37 (Fig 28)

Pot scatter was recorded within a feature of uncertain edges, consisting mainly of one grey ware jar (F93.1), probably used as a cremation urn, dated mid-late 2nd to 4th century. The feature appears to be in the line of a metalled Roman track (F43). The pot may have been deliberately smashed but it was also subjected to some later disturbance. 5.4g of human cremated bone was found in the feature fill, from an unsexed adult. Three flint-tempered Middle Bronze Age Deverel-Rimbury sherds were also recovered from the feature, dated 1400-1200 BC. They may be chance inclusions.

F93.1 (361, 591 and 370) sherds from a large narrow-necked grey ware storage jar Cam 280 (Fabric GX), probably used as a cremation urn, mid to late 2nd-4th century, plus a few other grey ware (Fabric GX) sherds, possibly all part of same pot (not illustrated).

Cremation burial F101/F107, T38 (Figs 29, 90)

F101 was recorded as a scatter of pottery (F107.1), charcoal and cremated bone within topsoil L1. Included in the scatter was a copper-alloy box fitting (F107.2), probably from a jewellery box which had been placed on the pyre, plus a glass bead (F107.3). On further excavation, a cut for a pit was revealed below F101 (F107). The finds from within the topsoil are likely to have been moved from F107 by gardening. The burial had then been cut through by post-medieval pit F105. The total amount of cremated human bone was 4g, from an unsexed adult. The feature is listed as an urned or probable urned cremation burial in the report on the cremated human bone (section 7.6), but it could also have been unurned.

F107.1 (408-409, 414, 427), small quantity of pottery sherds (Fabrics DJ and GX). Deriving from F101, F105 and F107. Includes one *terra nigra* eggshell ware sherd (Fabric UR(E)), pre-Flavian, a very small quantity of sherds from a bowl of from Cam 218 (Fabric GX), dated 1st-early 2nd century, and sherds from a flagon (Fabric DJ) dated 1st-2nd century.

F107.2 (410), SF 62, Heat-affected copper-alloy curved fragment of irregular grooved section, probably part of a ring-handle of a box. Length 18 mm, width 4.5 mm. Weight 1.5g.

F107.3 (411) SF 63, Fig 90, fragment of a bead of cobalt blue glass with two eyes of white around blue marvered into the surface. One eye stands a little proud of the surface, showing that the blue centre was added to the matrix as well as the white ring. The fragment is in two pieces, and the recent breaks are very jagged, while those formed in antiquity are remarkably smooth and have a slight rebate on each outer edge. The bead may have been broken and deliberately smoothed, or perhaps these unusual characteristics were caused by its having been split by heat. Diameter 32.5 mm, length 23 mm. The type belongs to Guido's class 3 (though on most examples the eyes are marvered flush with the bead's surface), which may be of Gaulish origin and which dates to the early Roman period in Britain (Guido 1978, 49-50).

F107.4 (414), SF 233, fragment of Mayen lava from a quernstone found in F105, therefore probably deriving from F107. The grinding surface is smooth. Maximum dimensions 56 by 61 mm, 31 mm thick.

Urned cremation burial F102, T43 (Figs 30, 78)

A jar (F102.1) was used as urn, placed in an oval pit. The jar is complete except for the rim. There were also some sherds of a bead-rimmed jar (F102.2). A small amount of cremated bone was recorded at the base of the pit but the weight was not recorded. The total amount of cremated human bone inside the urn was 61.1g, from a child of 2 to 3 years.

F102.1 (430) Fig 78, a complete jar, rim broken off, Cam 278 (Fabric GB), used as a cremation urn, c AD 130-180/200.

F102.2 (430) sherds of a bead-rimmed jar, Cam 328 (Fabric KX), early 2nd- late 2nd/early 3rd century.

Urned cremation burial F103, T38 (Figs 31, 79)

This consisted of a complete jar (F103.1), dated mid 2nd-late 3rd/early 4th century) used as cremation urn, in a circular pit, surrounded by 19 nails (F103.2). The nails may be from a box or from a wooden covering. Three fragments of melted blue/green glass (F103.3) were found inside the urn. The total amount of cremated human bone was 914.8g (all from within the urn). The bone is of a middle-aged person, probably female. The burial was adjacent to F108 and the two may be associated.

F103.1 (458), Fig 79, a complete grey ware jar Cam 268 (Fabric GX) used as a cremation urn, early/mid 2nd- late 3rd/early 4th century.

F103.2 (various find numbers), 19 nails, the complete ones range in length from 39 mm to 75mm (see Table 6 below).

F103.3 (458), 3 melted blue/green glass fragments from inside the urn.

Table 6: iron nails from F103, incomplete unless stated otherwise.

Find	Description	Length (mm)
422	1, complete; 1 nail head	66; -
429	1 shank fragment	28
433	1	34
434	1	36
435	1	40
444	1, complete	75
445	1 shank fragment	40
446	2	22, 17
448	1	41
449	1 shank fragment	44
453	2, both complete, smaller clenched	60, 39
455	1 shank fragment	61
456	1	30
458	1, complete	42
464	1, complete	42
558	1, complete	60

Cremation burial F108, T38 (Figs 31, 79)

This feature was next to and appeared to be cut by F103. A small complete jar (F108.1) and a small necked flask or flagon (F108.2) were placed at opposite ends of an oval pit. The jar was on its side. There was only a small amount (0.4g) of bone from the feature fill and this may not be burnt. No cremated bone came from within either vessel, and therefore this feature is classed as an unurned cremation burial (although it is listed as urned in the report on the human bone; see section 7.6). Alternatively it may be that F103 and F108 are the same burial and that pots F108.1 and F108.2 are ancillary vessels to the urn in F103. All three of these vessels were surrounded by nails F108.3 and F103.2). Those nails surrounding the jar (F108.1) are structural nails and may be from a wooden storage box placed in the pit after cremation. This box is similar to that found in F126. The pottery dates this cremation burial to the early 2nd-late 2nd/early 3rd century.

F108.1 (487), Fig 79, small bead-rimmed jar, Cam 328 (Fabric GB), early 2nd-late 2nd/early 3rd century.

F108.2 (562), Fig 79, miniature flask or flagon with pear-shaped body, rim missing (Fabric DJ), 1st-2nd century.

F108.3 (various find numbers) 17 nails, plus possible hobnails (see Table 7 below).

Table 7: nails from cremation F108, incomplete unless stated otherwise.

SF	Find	Description	Lengths (mm)
-	424	2 shank fragments	11, 9
-	432	1, tip only missing	76
-	457	1	43
-	477	2: 1 complete, 1 curved towards tip, w only missing	56, 40
-	478	1; 1 shank fragment	28; 24
-	479	1; 3 shank fragments	14; 8, 10, 30
-	533	1, complete	62
-	534	1	43
217	584	2 shank fragments, possibly from hobnails	7.5, 11
-	559	1, complete	65
-	560	1, complete; shank bent at tip	63
-	561	1, complete, shank curved at tip	48 (bent)
-	571	1, complete	59
-	572	1, complete, clenched	51

Cremation burial F113, T55 (Figs 32, 79)

This consists of the upper parts of two jars (F113.1 and F113.2), one (F113.2), almost complete, lying on their sides in a possible pit. Part of pot F113.2 was also recovered from topsoil L1 above. Cremated bone was absent. The burial is thought to be an urned cremation which has been dug through and redeposited.

F113.1 (539) Fig 79, fragments of jar, Cam 279c (Fabric GA), mid 3rd-4th century

F113.2 (540, 538) Fig 79, an almost complete jar although base missing, Cam 279c (Fabric GA), early/mid 3rd-4th century.

Urned cremation burial F114, T45 (Fig 33, 90)

A large flask used as a cremation urn (F114.1) was found in the centre of a circular pit, fallen on its side. The urn is cracked. The burial appears to be in the line of the possible metalled road F117 and it was not clear whether the burial had been dug through this or whether the road had been laid afterwards and perhaps displaced the urn. The ironwork from this burial includes a single complete link (F114.4) from a chain with parts of the adjoining links still attached. Two penannular loops (F114.2-3a) are probably also chain links. These pieces may represent a harness of some kind, but chains had so wide a variety of uses that it is impossible to be certain of the precise purpose of this example. The ironwork is thought to be a primary deposit, ie it was burnt on the pyre with the body.

One small fragments of glass (F114.9), some fragments of pottery (F114.8) and one retouched flint (F114.10) were found inside the urn. No cremated bone was observed in the pit fill, and the total amount of cremated human bone in the urn was 1488.1g. This was from a

middle-aged or old male. It is possibly fairly complete and well preserved with particularly large fragments of torso, a large occipital crest and robust bones, showing evidence of degenerative disease and partially obliterated cranial sutures; osteoarthritis of the right hip and osteophytosis of the spine, and small exostosis of the femoral shaft. Also, 47g of cremated animal bone came from inside the urn (see section 7.6).

F114.1, (542, 1150), a large flask, Cam 231/232 (Fabric GX), used as a cremation urn, 1st-late 2nd century.

F114.2, (537), Fig 90, oval penannular iron loop with the ends set at the centre of one long side, tapering and overlapping so that together they are of equal thickness to the rest of the loop. The point of one is slightly turned out. The opposite side is straight. Maximum diameter 69 mm, minimum diameter 36 mm, maximum width 18 mm.

F114.3 (524) SF 163, Fig 90:

a) Iron loop similar to F114.2 but in two fragments. Maximum diameter about 68 mm.

b) Iron nail with slightly domed round head, tip only missing. Length 57.5 mm.

c) Iron fragment, probably two crossing nail shank fragments. Maximum length 19 mm.

F114.4 (495), Fig 90, 1 iron figure-of-eight chain link. At each end there is a fragment of an adjoining link. Length 45 mm.

F114.5 (1154), SF 147, 1 fragment of iron sheet. Maximum dimensions 32mm by 23 mm.

F114.6 (526, 527, 542), 3 nails and small flakes of iron.

F114.7 (1157), SF 150, one irregular retouched flint, Iron Age or Roman.

F114.8 (1143), inside urn – fragments of pottery including a very small quantity of sherds probably from a Cam 108 beaker (Fabric GX) of the 1st-early 2nd century, one sherd of Fabric DJ, and a few other grey ware sherds (Fabric GX).

F114.9 (542), 1 small fragment of glass, blue/green, from inside the urn.

Urned cremation burial F115, T26 (Figs 34, 79)

A grey ware jar (F115.1) used as a cremation urn had been placed centrally within a circular pit. The top of the urn was caught by the bucket of the machine. Structural nails (F115.3) and abundant hobnails (F115.2) came from the fill of the pit and inside the urn. There was abundant cremated bone in the fill plus charcoal flecks, indicating that pyre debris was deliberately placed in the pit, around the urn and that the deceased was burnt with her hobnailed shoes. The quantity of hobnails indicates that the shoes had a Rhodes' Type C nailing pattern (Rhodes 1980, 107), as in the inhumation F171. The date of the urn is probably 1st-early 2nd century. The total amount of cremated human bone was 1,051.5g, from a female, young or middle-aged.

F115.1 (498), Fig 79, jar (Fabric GX) used as a cremation urn; a crack from mis-firing indicates that it maybe a second or a waster, probably 1st-early 2nd century.

F115.2 (various find numbers and small finds numbers) 112 hobnails, indicating shoes with a Rhodes' Type C nailing pattern (Rhodes 1980, 107),

F115.3 (1116, 1118, 1119, 1121, 1175, 497), 9 structural nails both in the pit fill and inside the urn, part of the pyre debris. Maximum length 48mm.

Urned cremation burial F118, T56b (Figs 35, 80)

This consisted of a grey ware jar (F118.1) used as a cremation urn, previously smashed and found within topsoil L1. There was no evidence of a cut, and the urn had been previously disturbed out of its original position. Cremated bone was found within the pot and a few fragments outside it. This burial consisted of 47.9g of human cremated bone, from an unsexed adult.

F118.1 (685) Fig 80, sherds from grey ware jar (Fabric GX), used as a cremation urn, probably early-mid 2nd century or later.

Boxed cremation burial F120, T14 (Figs 36, 80, 91-2)

This consisted of a circular pit with cremated bone at the base. The bone had been placed inside a small wooden box, represented by mineralised wood and metal fittings including the remains of copper-alloy rings, lock-bolt, studs, iron nails, part of the copper-alloy lock-plate and the hasp with copper-alloy and iron studs (F120.1-9 and F120.12). Textile (F120.10) attached to the inside of the lock-plate also survived. The textile is plain-weave woollen cloth which may represent the box lining or derive from clothing or a bag placed within the box. The box shows signs of repairs, and is likely to have been an old jewellery box. A small, complete 1st- to early

2nd-century bowl without cremated bone (F120.11) was placed within the pit, next to the box. All the cremated bone was lying on the base of the pit; in total there was 185.5g, from a middle-aged female.

Wooden box, dated 1st century, pre-Flavian, including several elements:

F120.1 (550), SF 71, Fig 91, part of a copper-alloy lock-plate with copper-alloy and iron studs, copper-alloy lock-bolt, copper-alloy binding strips, and fragments of wood, leather, and textile. The edges of the lock-plate are worn; maximum surviving dimensions 83.5 mm across by 60 mm high. It was attached to the box by six studs, only two of which survive complete. The rectangular hole for the hasp is on the left hand side and measures 17 mm by 5 mm. The key-hole is an inverted L-shape, with the lower edge damaged and running into a circular hole of the same size and on the same alignment as those for the side fixing studs. Below and slightly to one side of the keyhole is a round depression, 9 mm in diameter. This appears as a raised roundel on the inner face of the plate.

At the top of the left-hand side is a domed and flanged copper-alloy stud with iron shank; the flange edges are damaged, surviving diameter 17 mm. An iron shank from a similar stud survives at the bottom of the right hand side. A copper-alloy stud with short integral shank, probably a replacement for a missing composite stud, was fixed at the bottom of the left hand side; diameter 18 mm, height 11 mm. The iron shank of the upper left hand stud passes through a wooden board 11 mm thick (only the wood around the shank survives), and the end is fixed into a thin copper-alloy strip 11 mm wide and 40 mm long. The lower end of the strip is broken. On the outer face is a fragment of iron-replaced textile overlain by wood. Fragments of a similar copper-alloy strip survived behind the right hand side of the lock-plate; maximum surviving dimensions of largest piece 11 by 20 mm. A fragment of a wider strip, 24 by 15 mm surviving, probably ran horizontally with the bottom row of studs fixed into it. Small holes in some of the strip fragments, together with two tiny studs with convex heads, 5 mm in diameter and 5 mm long, show that the strips were fixed in position on the inside of the box before the composite studs were applied on the outside. Below is a third copper alloy stud (F120.7) and fragments of sheet from one of these strips.

The lock-bolt, 52.5 mm long, has six square perforations for the tumblers. A single copper-alloy shank, probably a surviving tumbler, is fixed in one of the holes and is evidence that the lock mechanism had broken in antiquity. A strip of mineral-replaced textile is attached to the lock-bolt; dimensions 30 by 15 mm. A few small pieces of mineral-replaced wood lie on top of this strip.

F120.2, (548), SF 69, Fig 91, a copper-alloy ring of complex grooved section with a small fragment, in two pieces, of the iron split-spike loop that would have attached it to the box. Internal diameter 20 mm, section diameter 4 mm.

F120.3, (595), SF 76, Fig 91, a small copper-alloy ring of narrow lozenge-shaped section with the loop of an iron ring-headed peg attached. Traces of copper-alloy sheet on the iron are from an escutcheon plate. Internal diameter of ring 18 mm, thickness 1.5 mm, height 2.5 mm. Head of ring-headed pin 6.5 mm wide, surviving length 7.5 mm.

F120.4, (549), SF 70, Fig 91, a copper-alloy ring of complex grooved section with about half of its iron split-spike loop. There are traces of mineral-replaced wood, the grain running transversely, across the surviving spike, which is bent sharply outwards near the end. Internal diameter 21 mm, section diameter 4 mm. Length of clenched spike (if straight) 26 mm. The board thickness given by the gap between the inner edge of the loop and the bend is 14-15 mm.

F120.5, (536), SF 72, Fig 92, Roman copper-alloy hasp for casket. Copper-alloy tongue-shaped hasp, with pairs of transverse mouldings near top and bottom. The loop to slot into the lock-plate survives. The top edge is moulded to give the impression that it is hinged upon an axial bar with end-knobs, but in reality it swivels upon the rudimentary pin cut from sheet metal that attached it to the lid. This is clenched to give a wood thickness of about 7-8 mm, but the inner face of the lid would probably have been rebated at that point to accommodate the lock mechanism. Length 56 mm, maximum width 26.5 mm. Length of pin (bent) 15 mm.

F120.6 (583), SF 75, a convex-headed copper-alloy stud, the central section missing and the shank separate. Diameter 14.5 mm, length of shank 12 mm.

F120.7 (601), SF 249, a small copper-alloy stud, and two small fragments of flat sheet (not illustrated). Length of shank 7 mm.

F120.8, (601), SF 218a, tapering fragment from the base of the loop and upper part of the shank of an iron ring-headed peg or split-spike loop. Length 11 mm.

F120.9, (601), SF 256a, fragment of the loop of an iron ring-headed peg or split-spike loop. Diameter 10 mm.

One of the ring-hinges and a stud on the lock-plate of the box had been replaced in antiquity and the lock mechanism had broken, making the box old when buried. The box measured at least 300 mm wide and was about 240 mm deep, much the same as similar boxes from the region (Borrill 1981, 304). The height is less easy to calculate but, given the height of the lock-plate and the hasp, must have been a minimum of 100 mm and is more likely to be closer to 150 mm. The boards used to make the box were about 11 mm thick and were fixed together by small iron nails. The plain lock-plate was positioned at the centre of the front board, held in position by six studs, three down each

side. The studs at the corners were composite, with domed and flanged copper-alloy heads and iron shanks. Only one of these now remains intact. One of the others is represented by the iron shank, the other two are missing, but one was replaced in antiquity by a copper-alloy domed stud with integral copper-alloy shank. Another wholly copper-alloy stud (SF 75) probably came from the centre of one side.

The hasp was fixed to the lid by a simple sheet-metal pin, but it is cast to appear as if it was hinged on an axial bar. Three copper-alloy rings were fixed to the box by ring-headed pegs or split-spike loops. They lay along the back of the box, a position that shows they formed the hinges. Rings were used as hinges on the boxes in Baldock burials 3 and 10 (Stead & Rigby 1986, 63, 75), on the box in burial 4 at Skeleton Green (Partridge 1977, fig 26, A4; Borrill 1981, 314-15), and as both hinges and strap-holders on a box recently excavated in west Essex along the Ickleton to Matching Green natural gas-pipeline (N Crummy 2003; ECC 2002b,12). Two of the F120 rings were of complex grooved section, the third was of lozenge-shaped section and appears to be another repair.

F120.10 (550), SF 71, textile attached to the inside of the box (see section 7.16). Fragments of textile associated with the lock-plate may have come from the lining of the box. It has been suggested that textile associated with other caskets was external and used to wrap them in before deposition, but others may have been lined with textile, while Reece, quoted by Philpott, has suggested that a brooch found in a box from Baldock may have been pinned to an item of dress (Saunders 1985, microfiche I:A13; Borrill 1981, 317, table 46; Philpott 1991, 13).

F120.11 (551), Fig 80, a complete small grey ware bowl, Cam 218 (Fabric GX), 1st-early 2nd century.

F120.12 (various find numbers) 26 nails. The iron nails from the box are small and complete examples have narrow, more or less rectangular, heads with irregular edges; the longest measures 32 mm, the others are 27, 28 (three examples), and 29 mm long. Mineralised wood survives on all the nails and shank fragments, and on some the grain runs transversely across the upper part of the shank and parallel to the lower part. The maximum thickness of the board indicated by the transverse grain is 11 mm, which matches the board thickness shown by the wood preserved behind the lock-plate. On one nail the grain is parallel to the full length of the shank (see Table 8 below).

Table 8: nails from the box in F120, incomplete unless stated otherwise.

SF	Find	Description	Length (mm)	Wood grain
-	553	1 shank, bent at tip	16	transverse
-	554	1	16	transverse
-	555	1 shank fragment	18	parallel
-	556	1 shank fragment	17	transverse
-	557	1, complete	32	11 mm transverse on upper shank, parallel on lower
-	573	1 shank fragment	15	transverse
-	574	1, complete	28	6 mm transverse on upper shank, parallel on lower
-	575	1, complete	29	6 mm transverse on upper shank, parallel on lower
-	576	1	23	transverse
-	577	1 shank fragment, bent tip	14	transverse
-	578	1 shank fragment	15	transverse
-	579	1	7	transverse
-	580	1	16	8 mm transverse on upper shank, parallel on lower
-	581	1, complete	28	parallel on lower shank, uncertain at end
-	582	1	16	transverse
-	585	1 shank fragment	17	transverse
-	586	1, complete	28	5 mm transverse on upper shank, parallel on lower
-	587	1 shank fragment	13.5	transverse
-	588	1, complete	27	parallel
-	593	1 shank fragment	10	transverse
-	594	1 shank fragment	10	transverse
-	596	1 shank fragment	6	transverse
218	601	3 shank fragments	13, 10, 11	transverse on all shanks
256	601	1; 7 shank fragments	12; 6, 8, 10, 12, 16	transverse on all shanks

Cremation burial or pyre debris F123, T54 (Fig 37)

This was a small pit containing pyre debris filled by mid to light brown sandy silt. The central part contained blackened sandy silt which had leached out to the edges of the feature through root action. Some charcoal and a very small amount of cremated bone was visible on the surface but this did not continue throughout the fill. A small quantity of broken 1st- to 3rd-century flagon sherds (F123.1) were present within the top 100mm of the feature fill but not at the base. Thirty-three nail shanks, one complete nail (F123.2) and burnt stone also form part of the pyre debris. The pit is cut by pyre debris dump F130. The bone was on the surface and not placed at the base of the pit, which suggests it is pyre debris rather than a deliberately-placed cremation burial. The total amount of cremated bone was 9.8g and it appears to be an infant, but the sex is not known.

F123.1 quantity of sherds (115g) of Fabric DJ, probably from a flagon(s), possibly more than one pot represented, dated 1st-2nd century.

F123.2 (636 and 604), SF 230, 34 iron nail shank fragments, one retains part of the head. Some may be from hobnails, but many are too long. Lengths range from 5mm to 23mm, apart from one complete nail of 34mm.

Urned cremation burial F126, T25 (Figs 38, 92, 103)

The sub-rectangular pit held a complete square mould-blown collared glass jar (F126.1) used as a cremation urn. This had been placed inside a wooden box (F126.2) of which only the nails and a few fragments of mineral-replaced wood survived. The size of the nails is much greater than those used to make jewellery boxes such as that in F120. This suggests that the F126 box was a stouter and more simply-made item, either a 'cremation coffin' or a box used for the storage of household goods. A fragment of a pebble (F126.3), possibly used as a polishing tool, is probably residual. It cannot have been inside the box, as it lay several centimetres above the floor, on the same level as the upper side of the fallen glass jar in the grave. It may, however, have been placed on the box lid. The glass jar contained cremated bone and one piece of glass which is probably a pyre deposit. The glass jar is probably Flavian to early 2nd century in date. The total amount of cremated human bone was 107.9g, from an infant aged 9-12 months, deduced from the teeth.

F126.1 (566), SF 73, Fig 103, a complete square glass jar used as a cremation urn; blue/green; tubular collared jar, rim edge first rolled in, then out and down; square body; slightly concave base; base detail of three concentric circular mouldings with central dot. Height 162mm, rim diameter 60mm, base diameter 100mm, probably Flavian to early 2nd century in date.

F126.2, a wooden box consisting of the following elements:

F126.2a (597), SF78, Fig 92, from one corner of the box. 1 iron nail, in two pieces, with most of the flat round head missing. The shank of the second nail passes across it at a slight angle 10mm below the head. Both the nail and the shank fragment are covered with traces of mineralised wood. As with SF77 below, the grain runs transversely across the upper shank of the complete nail and parallel to the lower shank of the complete nail. The board thickness is 30mm. Length of complete nail 69mm; length of fragment 24mm.

F126.2b (590) SF77, Fig 92, from one corner of the box. 1 complete iron nail with flat round head. The shank of a second nail passes across it at right angles 5 mm below the head. Both the nail and the shank fragment are covered with traces of mineralised wood, with the grain running transversely across the upper shank of the complete nail and parallel to the fragment, and parallel to the lower shank of the complete nail, giving a board thickness of 30 mm. Length of complete nail 78 mm, length of fragment 17 mm.

F126.2c (various find numbers), 15 other nails, mainly incomplete (see Table 9 below).

F126.3 (567), SF 74, rectangular fragment of a waterworn flint pebble or tool; the upper surface is more worn than the lower and it may have been used as a polishing tool, although the sides are rough. Length 41 mm, width 17 mm, thickness 10 mm. Possibly residual.

Table 9: nails from the box in F126, incomplete unless stated otherwise.

SF	Find	Description	Length (mm)	Wood grain
-	589	1 shank fragment	53	parallel (lower shank)
77	590	<i>see above</i>		
78	597	<i>see above</i>		
79	598	1	10	-
80	599	1 shank fragment	19	transverse
-	608	1, complete	58	transverse on upper shank, uncertain on lower shank
-	609	1, complete	65	transverse on upper shank, parallel on lower; board thickness 30 mm
-	610	1	35	transverse (upper shank)
-	611	1, complete	76	transverse on upper shank and probably for full length of shank
85	612	1 shank fragment (burnt)	48	-
86	613	1 shank fragment (burnt)	45	-
-	622	1, complete	67	transverse for full length of shank
-	623	1, complete	82	transverse on upper shank, uncertain on lower shank
-	624	1, complete	65	transverse on upper shank, uncertain on lower shank
-	625	1, complete	81	transverse on upper shank, parallel on lower shank
91	626	1	18	-
-	637	1, tip only missing	79	transverse for full length of shank

Urned cremation burial F128, T39 (Figs 39, 80, 92-3).

This consisted of an oxidised jar in a reddish fabric (F128.1) used as a cremation urn and placed in a circular pit. The top of the jar was clipped by hand-excavation. Fragments from a lid (F128.2) were retrieved from inside the urn plus iron nails (F128.3) from the pyre. Spit 6 of the urn fill contained a copper-alloy mirror (F128.4) and a complete comedy mask picture lamp (F128.5) of late 1st- or early 2nd-century date. These latter two items were not burnt and had been placed unburnt within the urn, on top of the cremated bone. No cremated bone came from the fill of the feature. The total amount of cremated human bone in the urn was 571.6g. The bone is from an adult, with a small amount from an infant. The infant bones may be accidental inclusions from a previous use of the pyre. A mackerel vertebra was found amongst the human cremated bone. The burial is of later 1st- or early 2nd-century date.

F128.1 (671), a large oxidised jar in a soft sandy reddish fabric (Fabric DJ), used as a cremation urn, very broken up and having lost its rim, probably early Roman, 1st-earlier 2nd century.

F128.2 (1141, 1153), Fig 80, fragments of lid, CAR 10, Type 163 (lid flat or slightly domed with upward hooked rim; Fabric DJ), used as lid to the urn and found inside urn jar, 1st-2nd century.

F128.3 (671, 1131, 1136,1156), 8 nails or nail shanks from inside the urn, from the pyre, some may be hobnails. Maximum length 32mm.

F128.4 (1152), SF 146, Fig 92, small round copper-alloy mirror found in spit 6 of the urn, probably of Lloyd-Morgan's group F, but the metal has been beaten out rather than cast. It also appears to differ from others of the group as it lacks the corrosion typical of high-tin bronze (speculum) and is most likely to be of low-tin bronze (Meeks 1995). Small round disc mirrors (but made of speculum) have been found in pre-conquest graves at King Harry Lane, St Albans but they are more often found in post-conquest contexts (Lloyd-Morgan 1977, 233, 243-51; Lloyd-Morgan 1981, 30-35; Stead & Rigby 1989, 103). Assuming this example to be contemporary with the lamp from the burial, it belongs to the later 1st or early 2nd century. The edge had been partly damaged through decay. One side is markedly polished, the other dull. There are no marks on the edge that may be evidence of a frame. Diameter 69 mm, maximum thickness 0.5 mm, thinner in places.

F128.5 (1151), SF 145, Fig 93, a late 1st- or 2nd-century complete factory lamp of Loeschcke type Xa, now cracked along the line of the joint between the upper and lower mould. The area around the wick hole is burnt. This example has no handle, but has two unpierced shoulder lugs and is decorated with a theatrical mask. The latter is flanked by two filling-/air-holes. A further small air-hole in the nozzle channel was indicated in the mould but has not been cut through. Set within multiple base rings is the maker's stamp FORTIS in relief. Even lamps bearing the same maker's stamp can be made in different production centres as the result of either pirating or branch workshops. FORTIS is the name of a particularly prolific 'maker' with the original workshop probably active from the Vespasianic period but with many products made in provincial workshops in the late 1st and 2nd century. Twenty-six lamps with his stamp have been recorded in Britain (Eckardt 2002a, 204), of which one from Colchester is of Loeschcke type IXc (Eckardt 2002a, 204, no 145;

Bailey 1988, 168, Q1616). The decorative design of the grotesque theatrical mask with wig and open mouth occurs on two other lamps found in London and Colchester but both are of Loeschke type IXb (Eckardt 2002a, fig 87, 560). Cream-buff fabric with orange-brown slip, probably Gaulish. This lamp should be dated to the very late 1st century or the first half of the 2nd century. Length 97 mm, width 65 mm, height 31 mm.

Urned cremation burial F129, T37 (Figs 40, 80)

This consisted of sherds of a grey ware jar (F129.1) which had been used as a cremation urn, placed in a small pit. The base of urn was upside down, with cremated bone underneath, indicating that the top of the urn had been truncated previously and moved. The total amount of cremated human bone was 259.5g, from a middle-aged or old person, probably female. Two nails, lengths 28mm and 54mm, came from the pyre.

F129.1 (629, 630), Fig 80, sherds from a jar, Cam 268 (Fabric GX) used as an urn, mid 2nd-early 4th century.

Urned cremation burial F133, T39/T52

23.3g of cremated bone was found in a small pit without any pottery.

Urned cremation burial F135, T34 (Figs 41, 81)

This burial consisted of a badly fired jar (F135.1) which was used as a cremation urn, placed centrally in a circular pit. No cremated bone was observed in the pit fill. The total amount of cremated human bone in the urn was 1002.7g, from a male, middle-aged or old. There was also 52g of cremated animal bone.

F135.1 (688), Fig 81, a bead-rim cooking pot Cam 259 (Fabric HD) used as urn, almost all of pot, part of rim missing (shaved off by the machine bucket). Post-firing hole made through base. Surfaces sooted, 1st century.

Urned cremation burial F137, T45/T46 (Figs 42-44, 81, 97, Plate 9)

This consisted of a deep pit containing a complete Dressel 20 amphora (F137.1). The neck of the amphora appeared to be missing, leaving a wide opening. Two graffiti had been scratched onto the neck of the amphora, next to one another. One was a probable pre-firing mark resembling a tulip or leaf and stem. The other was a probable pre-firing ruler-drawn Λ which may denote the letter 'A' or 'V' or the number 5. Letters or numbers were often scratched on amphora to label their contents, the quantity of liquid they carried, or even the owner (Paul R Sealey pers comm) The leaf symbol is a leaf-stop (see section 7.17 for discussion of the graffiti by E W Black). After the vessel had been lifted out of the ground mechanically, its contents were excavated. The neck with its attached handles was found inside the body of the amphora, and one handle had been stamped. The neck must have fallen into the amphora and knocked over the vessels that were placed inside. In the bottom of the amphora was a complete small beaker (F137.4), an almost complete jar used as a cremation urn (F137.2) with a complete dish on top (F137.3), and a small flagon (F137.5) to the side of the urn. The soil inside the dish contained a small lamp (F137.6), which may have been lit inside the cavity. The lamp was upside down to one side of the dish. It had probably been knocked over when the neck of the amphora fell inside the cavity (Fig 44). The fact that the urn had been given a lid (the dish) and that the amphora had been sealed makes it likely that the covering of the urn was as much symbolic as practical (Barber & Bowsher 2000, 109).

The total amount of cremated human bone (all within the urn) was 837.2g, from a probable female, aged 16-18. The factory lamp is likely to date to the very late 1st century AD; however, two of the pots are dated mid 2nd-early 3rd century, and the amphora dates to AD 125/150-175/210. The overall date of the burial is likely to be second half of the 2nd century AD.

The amphora cremation burial appeared to be in the line of the metalled road (F117). The metalling was recorded to the west and east of the pit for the amphora but it did not survive within 700mm of it.

The top of the cut for the pit in which the amphora was placed was 140mm higher than where the top of amphora would have been, therefore the top of the amphora cannot have been deliberately left protruding out of the ground in the Roman period.

F137.1 (708), Fig 81, a complete Dressel 20 amphora (Fabric AJ), with stamp on handle and 2 graffiti on the body, rim form AD 125/50-175/210. The upper part (shoulder, neck, and handles) had been

removed as one piece to allow the cremation, together with ancillary pots (F137.2-F137.5), to be placed inside the amphora body. It was found, with the pots, inside the amphora body. The single stamp is complete and consists of a rectangular die with three letters, but it is quite abraded and the letters are not legible. A rubbing of the stamp suggests that these letters are S or B followed probably by E and then P or F, but the letters are not clear. No obvious parallels were found for the stamp in either Callender (1965) or Funari (1996). See Section 7.17 and Figs 42-3, 81 for the graffiti.

F137.2 (1084, 1094), Fig 81, a jar Cam 278 (Fabric KX), used as an urn, almost complete, may be a kiln second as the base is slightly uneven, probably mid 2nd-early 3rd century.

F137.3 (1083), Fig 81, a complete dish Cam 40A (Fabric GB), used as a lid for F137.2, early 2nd to mid-late 3rd century.

F137.4 (1086), Fig 81, a complete small beaker, Cam 391 (Fabric CZ), early 2nd-late 2nd/early 3rd century.

F137.5 (1085), Fig 81, a complete ring-necked flagon Cam 156 (Fabric DJ), early 2nd to early 3rd century.

F137.6 (1106), SF 134, Fig 97, a lamp inside the dish. Complete factory lamp with a large mould-made handle and two shoulder lugs. The wick hole area shows signs of burning. Orange-buff fabric with mica-dusting characteristic of the London pottery industry thought to have been operating c AD 90-130 (Davies *et al* 1994, 136-9). Typologically, this lamp is of Loeschcke type IXb and it therefore probably dates to the very late 1st century AD. This example is unusual in that the top of the lamp is open. Another lamp with this feature but with a nozzle form that stands typologically between those of Loeschcke types IX and X was found on the probable lamp production site at Northgate House, London; it was associated with pottery dated to AD 140-160 (Eckardt 2002a, 86-92, fig 39, 2359). Length 85 mm, width 43 mm, height 21 mm.



Plate 9: amphora cremation burial F137, view north-west.

Urned cremation burial F141, T94 (Figs 45, 82, 97)

This consisted of a storage jar used as a cremation urn (F141.1), placed centrally in a circular pit. On top of the urn was a lid (F141.4) which had partly fallen into the urn, and a broken factory lamp (F141.2) on the top of the lid. The pit may have had a covering which no longer survives but which would have created a cavity needed for the factory lamp to be lit, if it had been lit. Two sherds from an earlier picture lamp (F141.3) were found inside the urn. It is difficult to be certain whether the incomplete picture lamp was a deliberate primary deposit from the pyre, rather than residual. It may be that this picture lamp (and that in F199) had been decorated with apotropaic images like those from F42 and F53, and its potency had been invoked by deliberate breakage at an earlier stage in the burial rite.

The urn was not placed right at the base of the pit; charcoally pyre debris had been deposited underneath and surrounding the urn. A minimum of eight hobnails or hobnail fragments represent a primary deposit of nailed footwear, but the grave also produced numerous iron shank fragments (F141.8), the smaller of which are probably also from hobnails. The other primary deposits are structural nails (F141.9) and a slag-like fragment. Cremated bone came

from the pit fill and inside the urn. There was burnt samian and fragments of a ring-necked flagon (F141.6) in the fill of the feature. Inside the urn were fragments of a butt-beaker and a flagon (F141.5), as well as a possible retouched flint (F141.7). The total amount of cremated human bone was 628.3g, from a probable female, middle-aged or older.

- F141.1 (981), Fig 82, a complete storage jar, Cam 270b (Fabric GX) used as a cremation urn, possible firing spall on body, 1st-2nd/3rd century. A lid had been placed over the top (see below).
- F141.2 (982), SF 137a, Fig 97, fragmentary but almost complete remains of a Loeschke type IXc factory lamp. In this type the raised rim around the discus extends in a narrow V-shape across the nozzle and towards the flat wick area. This example has three unpierced shoulder lugs, a central filling hole on the discus and a small air hole in the nozzle channel. There are signs of burning around the wick hole and on top of the lamp. The lamp has no base rings or maker's stamp. Buff-white fabric with good orange slip, possibly Gaulish. In Britain, the type is most common in the late 1st and into the early 2nd century (cf Eckardt 2002a, 190). A parallel from Colchester (Bailey 1988, 168, Q 1617) has the maker's stamp VRSIO. Length 90 mm, width 61 mm, height 25 mm.
- F141.3 (982), SF 137b, two sherds from inside the urn from the wall and wall/nozzle of a picture lamp; most of the slip has worn off the creamy brown-buff fabric. Either a primary pyre deposit or residual.
- F141.4 (1114) inside urn, a fragment of a lid **CAR 10** Type 163 (lid flat or slightly domed with upward hooked rim) (Fabric DJ), 1st-2nd century.
- F141.5, (1111, 1112, 1113), inside the urn a quantity of other pottery sherds and fragments which include a small quantity of sherds from a butt beaker (Fabric DZ) dated pre-Flavian, sherds from a small jar or beaker in oxidised ware (Fabric DJ) dated pre-Flavian (fig 82), and sherds from a flagon (Fabric DJ) dated 1st-2nd century.
- F141.6 (1003, 1004) fill of feature, small quantity of pottery sherds and fragments (Fabrics DJ, GX and FJ), and one burnt sherd of a samian cup, Drag 27, dated 1st-early 2nd century.
- F141.7 (1157), SF 150, inside the urn was one irregular flint piece, possibly retouched, dating from the Iron Age or Roman period.
- F141.8 (1003, 1114, 981), SF227 and SF135, hobnails or hobnail fragments.
- F141.9 (various finds numbers), at least 9 nails and other shank fragments.

Urned cremation burial F142, T58 (Figs 46, 82, 103)

This consisted of a complete jar (F142.1) used as a cremation urn which had been placed centrally in a circular pit. The fill contained pyre debris and was very charcoally. There was cremated bone in the fill, and pieces of melted glass including two unguent bottles (mid 1st century; F142.5-6). A few other grey ware sherds were present in the pit fill, some burnt or possibly wasters (F142.7). Four hobnails (F142.8) from the fill of the urn and the pit represent nailed footwear. An amorphous slag-like drip also came from the pit fill. The urn contained a complete but broken ceramic lid (F142.2) and fragments of another glass unguent bottle (F142.4) dating to the mid 1st century AD, and a glass lump (F142.3). The rim and neck area of the bottle show an altered surface, and are possibly heat-affected. It may have been a pyre good but, given that the degree of heat alteration is very slight, it must have been in a peripheral position if placed on the pyre. The altered surface may have been caused by its burial in contact with the hot cremated bone.

The urn and lid are 1st to 2nd or 3rd century. The total amount of cremated human bone was 915.4g, from a 16- to 18-year old male.

- F142.1 (725), Fig 82, a complete jar, Cam 266 (Fabric GX) used as a cremation urn, 1st-early 2nd century.
- F142.2 (1137, 1141), Fig 82, a complete but broken lid **CAR 10** type 239 (lids with plain rounded rim) (Fabric GX) (not a pot base), dated 1st-2nd/3rd century.
- F142.3 (725) – inside the urn one melted blue/green glass lump, weight less than 1g.
- F142.4 (1138, 1139, 1140, 1141, 1161), Fig 103, inside the urn and just under the lid was one tubular glass unguent bottle, blue/green, in seven joining fragments, lacking part of rim and body. Out-bent rim, edge sheared; cylindrical neck with tooled constriction at junction with tubular reservoir; slight concavity in base; slightly heat-affected at neck. Height 90mm, rim diameter approx 30mm; maximum body diameter 26mm.
- F142.5 (724) SF 101, Fig 103, in the pit fill 1 glass unguent bottle; blue/green; rim, neck and upper body fragment. Melted and flattened. Narrow rim edge now bent out horizontally; short cylindrical neck; sides sloping out possibly from tall conical reservoir. Present height 57mm, rim diameter approx 20mm.
- F142.6 (722, 781, 795, 796), several melted glass fragments from the pit fill: one melted blue/green fragment. 1g; one melted blue/green lump, weight 1g; three melted blue/green fragments, 1g; 11 melted blue/green fragments ranging from fully melted to body fragments showing jig-saw fractures. Weight 7g.

- F142.7 (723, 725, 796), Fabric GX grey ware pottery from the pit fill and inside the urn, some from a Cam 266 jar, oxidised/heated, burnt or a waster.
F142.8 (725, 795, 796), SF221, SF222, 4 hobnails.

Urned double cremation burial F162, T63 (Figs 47-49, 82, 97)

This was a long (1.4m), wide (0.65m), rectangular cut containing a jar (F162.1) used as a cremation urn, with a lid (F162.2) in place. The rim of the urn had been deliberately removed in antiquity. A complete flagon (F162.3) had been placed to the south-west of the urn. The cut started 0.9m below ground-level. The size and depth below ground-level of the cut resembled a grave cut for a child inhumation more than a cremation. However, no inhumed bone was present. It is tempting to surmise that the cremation burial was placed in a pit which was originally intended for an inhumation, especially as the feature is surrounded by other inhumations. However, the pottery and other finds suggest a 1st-century date which is before the practice of inhumation is thought to have commenced in Colchester. The cut was orientated NE-SW and the pots were placed in the southern half. The urn contained a complete small beaker (F162.4), a melon bead (F162.6), and a copper-alloy finger-ring (F162.7), all of which had been placed on top of the cremated bone and had not been burnt in the pyre. A child's broken ivory armband was mixed with the cremated bone at the base of the urn (F162.8; Fig 49). There was a small amount of cremated bone to the north-east of the urn which was from an older adult. The cremated bone from within the urn was both child (aged about three years) and an adult, both unsexed. The fill of feature contained one unburnt eel vertebra (F162.11) and one chopped sheep or goat bone (F162.10) which had been burnt at a high temperature. The urn is 1st century, possibly pre-Boudican, but the beaker is 2nd century. The melon bead indicates a date in the second half of the 1st century. Nails (F162.9), some possible hobnails, were found in the fill of the feature, and one nail was found inside the urn. The total amount of cremated human bone was 274.8g.

- F162.1 (864), Fig 82, an unusual double-cordoned jar used as a cremation urn, rim removed in antiquity, dated ?1st-2nd century.
F162.2 (863), Fig 82, broken lid, *CAR 10* type 242 (lids with squared off rim; Fabric GX), used as lid for urn, dated ?1st-2nd/3rd century.
F162.3 (862), Fig 82, a complete flagon, Cam 156 (Fabric DJ), 2nd century.
F162.4 (865), Fig 82, a complete small beaker, Cam 391 (Fabric CB), early 2nd-late 2nd/early 3rd century.
F162.5 (855) a small quantity sherds of Fabric DJ, found at the base of the cut, near to the flagon, sherds dated 1st to 2nd century.
F162.6 (877), SF108, Fig 97, melon bead of turquoise frit. Maximum diameter 20 mm, length 16.5 mm, second half of 1st century.
F162.7 (878), SF109, Fig 97, a plain copper-alloy finger-ring of D-shaped section. Internal diameter 14.5 mm, thickness 3 mm, height 3.5 mm.
F162.8 (1145-8), SF 141-144, Fig 97, a child's broken ivory armband of more or less elliptical section. Internal diameter 50 mm, section diameter 6mm by 7.5 mm.
F162.9 (884, 893, 1144), SF 251, SF 224, 13 nails, some structural, some possibly hobnails from fill of pit and fill of urn, maximum length 56mm.
F162.10 (895), 1 chopped sheep or goat vertebra, burnt at high temperature.
F162.11 (no finds no) 1 unburnt eel vertebra.

Urned cremation burial F165, T68 (Figs 50, 83)

This was a roughly circular cut with a possible further cut to the north. The main cut contained a complete jar used as a cremation urn (F165.1), slightly on one side. Slightly higher up and touching the urn was complete dish (F165.2) which may originally have been placed on top of the urn, to act as a lid. At the top of the cut was a small beaker or jar (F165.3), the rim of which had been slightly damaged. It appeared that the pit had been partially backfilled before the small jar was deposited. The urn contained iron nails and hobnails (F165.5) above the cremated bone plus pottery fragments, with the cremated bone at the base. The total amount of cremated human bone was 700.1g and this all came from inside the urn. The bone is of unsexed adult, aged middle-aged or older.

- F165.1 (871), Fig 83, a complete jar, Cam 268 (Fabric GX) misfired oxidised fabric, used as a cremation urn, early/mid 2nd-late 3rd/early 4th century.
F165.2 (903), Fig 83, a complete dish Cam 37A (Fabric GB) early 2nd-2nd/early 3rd century.

- F165.3 (859), Fig 83, a beaker or jar and an everted rim (Fabric ?GP). The pot is two-thirds complete and has firing spalls on the body, kiln second, dated ?late 1st to early 2nd century.
- F165.4 (946) from within pit fill, small quantity of pottery sherds of Fabric GX and Fabric DJ (the sherds of Fabric DJ are probably from a flagon).
- F165.5 (various find nos), iron fragments inside the urn plus 12 nails from inside the urn and from the pit fill (see Table 10 below).

Table 10: nails from F165, incomplete unless stated otherwise.

SF	Find	Description	Lengths (mm)
-	871	2 shank fragments	26, 13
152	906	1, complete, clenched	54
-	906	1 shank fragment, clenched	36
-	907	1, complete, clenched	78
-	909	1, complete	66
-	910	1, clenched, head damaged	44
-	937	1, tip only missing	44
-	1125	1, complete, clenched	77
-	1128	1, tip only missing	56
-	1130	1	46
-	1133	1, complete, clenched	67

Cremation burial F172, T29/T30

This was a spread of cremated bone and a number of grey ware sherds from a jar/bowl possibly representing a cremationurn, occurring 350mm below ground-level. This was observed while contractors were stripping the oversite after concrete had been poured into the foundation trenches. This feature was not excavated because it was not going to be further disturbed.

Cremation burial F176, T72 (Fig 51)

A spread of fragments from at least three Roman pots dating mainly from the 1st/2nd to 3rd century. No cremated bone was present and no cut was visible. The jar/bowl (F176.1) is likely to be from an urned cremation burial. Peg-tile and post-medieval pottery was found with the Roman pottery and tile.

F176.1 (924), much of jar/bowl with cordon, though the rim is missing (Fabric GX), Cam 266/104, 1st to early 2nd century.

F176.2 (924, 925, 928), various sherds, one rim fragment from a platter Cam 14/28 (Fabric UR LTC) pre-Flavian, some sherds/fragments of Fabric DJ flagon, one sherd of Fabric GX, and one sherd Fabric EA dated mainly 1st-3rd century but 1 sherd of mid 3rd-4th century.

Urned cremation burial F178, T76 (Figs 52, 83)

This consisted of a spread of broken pottery representing a bowl (F178.1) used as cremation urn. Most of the base was present. Sherds from a flagon (F178.2) were also present, both dating from the 1st-early 2nd century. These pots were at the base of topsoil L1 along with a few nails and hobnails (F178.3). Most of the cremated bone was at the base of the urn but some fragments were spread about above it. Further excavation of the feature revealed a small sub-rectangular cut. The feature had obviously been truncated and moved by later activity. The total amount of cremated human bone was 751g, from a probable male, aged approximately 16 years old. This cremation showed the most structured pattern of bone collection from the site. A comparison of the bone in the spits within the urn showed an increase in the amount of skull towards the bottom of and outside the vessel; although the patterning is not particularly clear, there is a slight suggestion that the burnt bone was collected from the head end of the pyre first, working down to the feet (see Section 7.6).

F178.1 (920), Fig 83, most of a bowl, Cam 218 (Fabric GX) some of rim missing, used as a cremation urn, 1st-early 2nd century.

F178.2 (921), flagon body sherds (Fabric DJ), 1st-early 2nd century.

F178.3 (920, 941, 942, 944), 3 iron hobnails and shanks from three other probable hobnails and 7 structural nails from within the urn and within the pit fill, maximum length 51mm.

Urned cremation burial F179, T79 (Figs 53, 83)

This consisted of the base of a grey ware jar (F179.1) used as cremation urn, and an almost complete grey ware flask (F179.2), with most of its rim missing, found within a possible oval cut. The pottery is mid 2nd-4th century. There was one hobnail in the urn (F179.3). All of the cremated bone came from inside the urn and amounted to 237.9g. The individual is unsexed, and is middle-aged or older.

F179.1 (936), Fig 83, most of jar, Cam 268 (Fabric GX), mid 2nd-early 4th century.

F179.2 (935), Fig 83, flask, Cam 280/281 (Fabric GX) most of rim missing but almost complete, uneven base, possibly a kiln second, mid to late 2nd-4th century.

F179.3 (936), 1 hobnail from within urn.

Urned cremation burial F180, T77/78 (Figs 54, 83)

This consisted of a grey ware bowl (F180.1), broken in antiquity but almost complete, which had been used as a cremation urn, and dated 1st-early 2nd century. Lying on top of the bowl was the base of another grey ware pot which had been heavily burnt, probably on the pyre (F180.2). There were sherds of pottery from other vessels to the north of the urn (F180.3, F180.4). At least eight nails and 33 hobnails were present outside and inside the urn. Cremated bone was recorded above the urn. A cut only became visible further down within L40, but cremated bone and some pottery was present above it. The total amount of cremated human bone was 585.5g, most coming from inside the urn, from an adult male.

F180.1 (930), most of a grey ware bowl Cam 218 (Fabric GX) used as a cremation urn, pot is very broken up but almost complete, 1st-early 2nd century.

F180.2 (938), Fig 83, base of grey ware pot (Fabric GX), very burnt, 1st-early 2nd century..

F180.3 (931, 932), Fig 83, base and rim of Cam 120B (Fabric GX), 1st century.

F180.4 (932), small quantity of sherds from a flagon (Fabric DJ) 1st-2nd century, and one sherd from a beaker Cam 108 (Fabric GX) 1st-early 2nd century.

F180.5 (913, 930, 933, 934), 33 hobnails and at least 8 nails from inside and outside the urn.

Urned cremation burial F181, T56 (Figs 55, 84)

This consisted of a grey ware jar (F181.1) used as cremation urn, which had been placed in a circular cut. The urn was almost complete but the rim had been broken off in antiquity. Some sherds of the urn were found inside it, as well as a flagon handle (F181.2). One melted glass lump probably from an unguent bottle (F181.3) was found at the bottom of the urn. The total amount of cremated human bone was 183.5g, which all came from within the urn and was from an unsexed older adult. Two fishbone fragments also came from the inside the urn.

F181.1 (1105), Fig 84, all of the body and shoulder of a large jar (Fabric GX) used as a cremation urn, rim missing, dated 1st-2nd century.

F181.2 (1105), flagon handle (Fabric DJ), 1st-2nd century.

F181.3 (1135), SF 194, 1 melted blue/green glass lump, 10g, from spit 3 of the urn. Its form is unidentifiable but the weight would be equivalent to a small unguent bottle.

Cremation burial or pyre debris deposit F182, T79 (Fig 56)

This consisted of cremated bone which was scattered throughout a square pit. Seventeen structural nails and 34 hobnails (F182.3-4) in no particular pattern were also present in the fill. A quantity of potsherds were mixed in with the bone, mainly from one grey ware pot (F182.2) and a flagon (F182.1) which appeared burnt (1st-2nd century). This feature could be a pyre debris deposit; however, without any charcoal it is more likely to be a cremation burial, possibly unurned. The total amount of cremated human bone was 747.1g, from an old male.

F182.1 (970 and 972), quantity of sherds from a flagon, Cam 154/155 (Fabric DJ) possibly slightly burnt, 1st to mid-late 2nd century.

F182.2 (970 and 972), small quantity of grey ware sherds (Fabric GX), dated ?1st- 2nd century.

F182.3 (951, 969, 972), SFs 155, 201, 255a, from the pit fill, 34 hobnails or hobnail fragments from footwear, considered to be primary deposits which were burnt on the pyre.

F182.4 (various finds nos), 17 structural nails and shanks from further nails, considered to be primary deposits which were burnt on the pyre (see Table 11 below); many of these are complete and range in size from 45 to 55 mm.

Table 11: nails from F182, incomplete unless stated otherwise.

SF	Find	Description	Lengths (mm)
225b	972	1; 5 shank fragments	10; 13, 14, 131
-	948	1, complete; tip of second nail corroded to head	46; 15
-	949	1; 1 shank fragment	18; 15
-	950	1, complete	45
-	952	1, complete	55
-	953	1, complete	41 (bent)
-	954	1, complete	50
-	955	1 shank fragment	28
-	956	1, complete, clenched	47
-	957	1	48
-	958	1	40
-	961	1, complete	48
-	962	1	33
-	963	1, complete	48 (slightly bent)
153	966	1; 1 shank fragment	20; 20, 26
-	967	1	36
-	968	1 shank fragment	32

Cremation burial F184, T81 (Fig 57)

This burial was represented by the base of a 1st- to early 2nd-century grey ware pot (F184.1) lying face down within post-medieval topsoil layer L38. No cremated bone was found and no cut was visible. This is likely to be the remains of an urned cremation which had been truncated and moved from its original location.

F184.1 (964), grey ware sherds/fragments from a jar (Fabric GX) plus one other fragment (Fabric GX) dated ?1st-early 2nd century.

Urned cremation burial F186, T88 (Figs 58, 84)

This consists of a grey ware jar (F186.1) which had been used as a cremation urn, placed in a circular pit, dated to the 1st to early 2nd century. The top of the urn was broken during hand-excavation, but otherwise it was virtually complete. There were a few fragments of other grey ware pottery (F186.2) in the fill which could have been burnt. Cremated bone was present in the fill, mainly in the lower fill and underneath the urn. Four nails (F186.3) were also found in the pit. The total amount of cremated human bone was 195.4g, from an unsexed child, approximately 12 years of age. A comparison was made of the bone within the spits by the bone specialist which showed that there was a fairly even spread of identifiable fragments in no obvious anatomical order (see section 7.6).

F186.1 (998), Fig 84, broken but almost complete jar, Cam 266 (Fabric GX) used as an urn, 1st-early 2nd century.

F186.2 (997, 998), small quantity of grey ware sherds showing signs of burning.

F186.3 (998, 999), four nails and small fragments of iron from the fill of the urn.

Double cremation burial F192, T102 (Figs 59, 84)

This is a complete grey ware urn (F192.1) which had been used as a cremation urn and placed centrally in a pit with a small complete eggshell ware beaker just to the north of it (F192.2). Both vessels are of the 1st-early 2nd century. The beaker was not placed on the bottom of the pit but further up. The urn contained two hobnails and one complete iron nail (F192.3, possibly a large hobnail); both may be residual. The total amount of cremated human bone was 750.2g, all from inside the urn. Two adult individuals are represented, one definitely female. It is possible that

F192 and F195 are the same two individuals spread between two urns, but they were placed quite far away from each other.

F192.1 (1034), Fig 84, a complete jar, Cam 266 (Fabric GX) used as a cremation urn, mis-shapen kiln second, 1st-early 2nd century.

F192.2 (1033), Fig 84, small complete white eggshell ware beaker with wide out-turned lip mouth, Marsh type 11 (Marsh 1978, 144-6; Fabric DZ) dated early 2nd century. This pot type is very unusual in Colchester, though has been classified by Marsh as his type 11 (Marsh 1978, 144) and the illustrated pot figure 6.8 11.1 (though rouletted) is similar in form to the pot from the Handford House site. The pots listed by Marsh occur in marbled ware, eggshell ware and mica-dusted ware. There are no examples in the Camulodunum type series or in *CAR 10*, and it appears that this pot type has not previously been recognised in Colchester. Five other examples of these pots have come from pits dated to the early 2nd century in Southwark, London (Marsh 1978, 146).

F192.3, (1034), 2 hobnails and 1 iron nail from inside the urn.

Urned double cremation burial F195, T107 (Figs 60, 85)

This consisted of a complete grey ware jar (F195.1) used as a cremation urn, dated mid 2nd to late 3rd/early 4th century, with the lower part of a jar or bowl used as a lid (F195.2). These were placed centrally in a circular pit. There was no bone in the pit fill. The total amount of cremated human bone in the urn was 772.5g. The bone is from two adult individuals, the older one definitely male. It is possible that F192 and F195 are the same two individuals divided between two urns, although they were placed quite far apart from each other.

F195.1 (1050), Fig 85, whole grey ware jar, Cam 268 (Fabric GX), used as a cremation urn, early/mid 2nd-late 3rd/early 4th century.

F195.2 (1051), Fig 85, lower part of a grey ware jar or bowl (Fabric GX) used as a lid, early 2nd-late 3rd/early 4th century.

Cremation burial or pyre debris deposit F197, T107 (Figs 61, 101)

This was an irregular-shaped, shallow pit containing abundant cremated bone down nearly to the base of the feature. Charcoal flecks were recorded in the top fill including one area of dense charcoal. There was a small quantity of small Roman pottery fragments (F197.1) throughout, from at least two vessels, but there were no diagnostic pieces. Several probable structural nails and one possible hobnail (F197.2) came from the fill. These were in no particular concentrations, and therefore can probably be interpreted as pyre debris. There was also an unburnt Roman coin (an *as* of the 1st to 2nd century (F197.3), and some iron slag (F197.4). F197 may be a pyre-debris deposit associated with another cremation burial rather than a cremation burial itself. Two post-medieval or modern dress pins are intrusive. These and the two sherds of post-Roman pottery show that the feature had been partially truncated, probably by the digging of the modern concrete foundation above. The total amount of cremated human bone was 153.2g, from an adult female.

F197.1 (1060, 1067, 1076), a small quantity of Roman pottery sherds, Fabric GX and Fabric DJ, Roman.

F197.2 (1058, 1072, 1073, 1076), 10 probable structural nails, most incomplete, 1 may be a hobnail. Maximum length 48mm.

F197.3 (1057), SF 121, Fig 101, copper-alloy coin, an *as* of Vespasian, date AD 70-71. Reverse is *Securitas August*.

F197.4 (1076) 1 fragment of iron slag.

(1067, 1076) SF 202, SF 245, two post-medieval/modern small copper-alloy dress or sewing pins which are intrusive.

Urned cremation burial F198, T108 (Figs 62, 85, 101)

A complete jar (F198.1), used as a cremation urn, dated probably mid-late 2nd to early 3rd century AD, had been placed centrally in a small circular pit. The urn contained an unburnt coin, a *sestertius* of Antoninus Pius (F198.2) in its upper fill, which suggests a date in the mid 2nd century for the burial, but hoard evidence demonstrates that bronze 2nd-century coins remained in circulation up to the early 4th century, and the grave may therefore be considerably later than implied by the minting date of the coin. There was also one sherd of a flagon (F198.3) inside the urn. There was no cremated bone in the fill. The total amount of cremated human bone within the urn was 1,129g, probably from a middle-aged or old male. A comparison was made of the bone within the spits which showed that there was a fairly even spread of identifiable fragments in no obvious anatomical order (see section 7.6).

- F198.1 (1078), Fig 85, a complete jar, Cam 278 (Fabric GB, in black-burnished ware category 2 (or BB2)), used as a cremation urn, probably mid-late 2nd to early 3rd century.
- F198.2 (1098), SF 131, Fig 101, copper-alloy coin, a *Sestertius* of Antoninus Pius, AD 143-4. Reverse is *Salus*.
- F198.3 (1099), 1 sherd of a white ware flagon, ?1st-2nd century.

Urned cremation burial F199, T108 (Figs 63, 85, 98-99)

This was an oval pit which had two distinct fills. The northern half contained a complete 1st- to early 2nd-century jar (F199.1) used as a cremation urn, and a complete factory lamp (F199.2), dating to the last quarter of the 1st century, which had fallen to the side of the urn. The lamp would probably have been placed on top of the urn originally, perhaps on a wooden lid which no longer survives. This side of the pit also contained sherds from a second lamp, a picture lamp (F199.3, AD 49-60/1) which does not seem to have been burnt. The picture lamp sherds may be a primary deposit or may be residual. The northern half did not contain any pyre debris or cremated bone. The southern half of the pit was filled by charcoally pyre debris with cremated bone and smashed burnt fragments of a flagon (F199.4). This southern side also contained a scorched coin of Vespasian (F199.5; AD 69-79), at least one hobnail (F199.8), a bone die (F199.7), and fragments of copper-alloy fittings from a jewellery box (F199.6). The coin is scorched, but none of the box fittings appear to have been burnt. It may be that pyre debris was put inside a jewellery box before being deposited in the southern half of the pit, next to the urn, as this would account for the unburnt box fittings and the very distinct division between the fills. The total amount of cremated human bone was 704.5g, from an adult female.

- F199.1 (1066), Fig 85, a complete jar, Cam 266 (Fabric GX), used as a cremation urn, 1st-early 2nd century.
- F199.2 (1065), SF 124, Fig 98, a large factory lamp of Loeschcke type IXb. The tip of the nozzle is damaged and the area around the wick hole shows signs of burning. The lamp has two unpierced shoulder lugs, a filling-hole set slightly off-centre and two air-holes, one in the discus and one in the nozzle channel. Traces of knife paring are visible on the underside of the nozzle. Orange-reddish fabric with large ?chalk inclusions. The maker's stamp is POETASPI. Phoetaspus is a North Italian producer of Loeschcke IX factory lamps (Bailey 1980, 100) whose output can be dated to the last quarter of the 1st century. Length 112 mm, width 79 mm, height 33 mm.
- F199.3 (1063), SF199, Fig 99, 9 fragments originating from the wall, shoulder and discus edge of a small picture lamp, with no element of the design remaining. Probably dated to AD 49-60/1. The lamp was poorly moulded and/or worn and has a buff-white fabric with a very worn brownish slip. It is almost certainly a local Colchester product, in which case a pre-Boudican date can be suggested. It may be a primary deposit or, considering the difference in date with SF 124, residual.
- F199.4 (1062, 1068), quantity of sherds and fragments from a large ring-necked flagon, Cam 155 (Fabric DJ), dated 1st-2nd century.
- F199.5 (1080), SF127, a coin, an *as* of Vespasian, reverse is *Victory*, dated AD 69-79. The coin was scorched.
- F199.6, copper-alloy fittings from a jewellery box:
- (1071), SF 125, fig 99, copper-alloy ring-handle of faceted section, in two pieces. Internal diameter 16.5 mm, thickness 3 mm, height 4 mm.
 - (1069), SF 122, fig 99, copper-alloy stud with small flat head and square-section shank. Diameter 9 mm, length 15 mm.
 - (1062), SF 192, copper-alloy stud in several tiny fragments. The centre above the shank was domed, but the other pieces are flat. Surviving length of shank 6 mm.
 - (1077), SF 126, small copper-alloy sheet fragment, possibly part of a stud head. Surviving length approximately 6 mm.
 - (1062), SF 248, small fragments of copper-alloy sheet, either part of a stud head or of a sheet-metal box fitting. Largest fragment 6 by 8 mm.
 - (1070), SF 123, thin fragment of copper-alloy sheet, in two pieces. Maximum dimensions 21 by 10 mm, 1 mm thick. Possibly part of a lock-plate or other box fitting.
- F199.7 (1064), SF 284, Fig 99, fragment of a bone die made from a long bone with the marrow cavity left as an unplugged hole. The only surviving edge is 16 mm long. The sides for 1 and 2 are identifiable, the latter from two widely-spaced double ring-and-dot motifs set in diagonally opposite corners, the former from the absence of a motif in the two surviving corners. Only one corner survives on the hollow faces, and on each face it contains a ring-and-dot. Assuming this die conformed to the Roman norm of opposite sides totalling 7, the hole must have passed through the sides for 3 and 4, providing complete faces for the numbers 5 and 6, which required most motifs. Similar hollow dies with the hole passing through the 3 and 4 sides have been found on the Lion Walk and the Gilbert School sites in Colchester (CAR 2, fig 102, 2501; CAR 6, fig

6.16, 193). The latter dates to c AD 49-60/1, the former came from a later 2nd-century context. A pair of hollow dice, each again with the hollow apparently passing through the sides for 3 and 4, were found in a grave dated to AD 30-55 at King Harry Lane, St Albans (Stead & Rigby 1989, 108, 178, fig 92, 20).

F199.8 (1062, 1075, 1081, 1082), iron nails probably from the pyre, mainly incomplete (some may be hobnails) mainly from southern fill. Maximum length 36 mm.

Urned cremation burial F200, T114 (Figs 64, 86, 99)

This was an almost complete jar (F200.1) used as a cremation urn, with some rim fragments broken loose, which had been placed in a circular pit. The jar is dated probably early-mid 2nd to late 2nd/early 3rd century. The pit fill contained charcoal flecks and staining but no cremated bone. The urn contained a small sub-square mirror (F200.2) which is fragmentary but probably complete: it is unburnt and is therefore a secondary deposit. Remains of a wooden backing survived under the mirror, above the cremated bone. A single iron nail (F200.3), apparently unburnt and with mineral-replaced wood surviving on the shank, appears also to be a secondary deposit, but the reason for its inclusion is uncertain, unless it was a token part of a larger object. The total amount of cremated human bone was 1322.7g including many large identifiable pieces. The bone appears to be from a male, based on the size and robustness; however, the presence of the mirror suggests a female. A study was made of the bone in each spit of the urn to compare the relative proportions of the four main skeletal areas. There was a fairly even spread of identifiable fragments in no obvious anatomical order (see Section 7.6).

F200.1 (1167, 1168), Fig 86, an almost complete jar, damaged (rim broken away) after burial, Cam 278 (Fabric KX) used as a cremation urn, probably early-mid 2nd to late 2nd/3rd century.

F200.2 (1173), SF 200, Fig 99, small square/rectangular mirror, now in fragments, some very small, but presumably deposited complete. Further fragments were recovered from environmental sampling (find nos 671 and 1168). The surfaces have patches of the distinctive corrosion of high-tin bronze (speculum). One surface is very highly polished, the other dull. The edge itself is slightly irregular, and varies from bevelled to vertical. Largest piece measures 46 by 43 mm.

This Continental-made mirror is of Lloyd-Morgan's group A, which was very popular in the 1st century AD and had an empire-wide distribution; 45 were listed from Britain in the mid 1970s. Complete examples range in size from about 65 by 70 to 110 by 130 mm (Lloyd-Morgan 1977, 243-52; Lloyd-Morgan 1981, 3-20).

The mirror would have been set in a lidded wooden frame or stored in a wooden box. An example from Towcester, Northamptonshire was found with the back of the frame intact (Lloyd-Morgan 1981, 3). A fragment from Hayling Island came from a Claudian context and there is an example from Southwark from a mid 1st-century female inhumation (G Softe pers comm; Lloyd-Morgan 1980, note 7).

F200.3 (1168, 1174), inside the urn - 1 complete iron nail with slightly domed head. The shank is covered with mineral-replaced wood (unburnt), with the grain lying along, not across, it. Length 40 mm. There were also flakes of iron inside the urn.

Urned cremation burial F201, T131 (Fig 65)

This consisted of an almost complete jar (F201.1) used as a cremation urn and which had been placed in an oval pit, dated probably early-mid 2nd to late 2nd/early 3rd century. To the south was an almost-complete 2nd-century flagon (F201.2). The urn contained one flint trimming flake (F201.3). Cremated bone was present in both the urn and the flagon but not in the pit fill, nor was there any charcoal. The total amount of cremated human bone was 572.7g, from an adult, probably female. A comparison was made of the bone within the spits which showed that there was a fairly even spread of identifiable fragments in no obvious anatomical order (see Section 7.6).

F201.1 (1177), Fig 86, an almost complete jar, Cam 278 (Fabric GB) used as a cremation urn, probably early-mid 2nd to late 2nd/ early 3rd century. Disfiguring mark on shoulder, possibly a kiln second.

F201.2 (1178), Fig 86, almost complete cup-mouth flagon, Cam 156 (Fabric DJ), 2nd century.

F201.3 (1177), 1 flint chipping, a trimming flake, tertiary (without any cortex), undated.

Unurned cremation burial or pyre-debris deposit F203, T126 (Fig 66)

This consisted of a circular cut containing frequent cremated bone fragments throughout and some charcoal staining, plus sherds and fragments from a ring-necked flagon (F203/1; 1st-2nd century) and a Cam 266 jar (F203.2; 1st-early 2nd century) plus one other grey ware sherd. The sherds showed no signs of burning. There were over one hundred hobnails within the fill, indicating that the burial was of an adult wearing hobnailed shoes. Approximately five structural

nails, which had been placed on the pyre, were also present in the fill of the pit (F203.3). The total amount of cremated human bone was 810.1g, from an unsexed adult. This feature could be pyre debris or an unurned cremation burial. The amount of cremated bone indicates a burial, however the presence of the bone throughout the fill rather than a concentration at the bottom of the pit is more usual of pyre debris.

F203.1 (1180, 1181), sherds and fragments from a ring-necked flagon, Cam 155 (1st-2nd century), sherds from a jar Cam 266 (1st-early 2nd century), 1 other grey ware sherd (Fabric GX).

F203.2 (1180, 1181), 111 hobnails from nailed footwear plus about five structural nails, maximum length 81mm, are the only primary deposits. The number of hobnails recovered points to this being an adult burial with shoes with a Rhodes type C nailing pattern, as in the inhumation F171 (Rhodes 1980, 107).

Cremation burial F204, T124 (Figs 67, 86-7)

A cremation burial, probably originally urned, was found within a large circular cut. The fill contained charcoal staining, charcoal fragments and a small amount of cremated bone (20.9g). The main component of this burial was a large Brockley Hill amphora (F204.2), in pieces but approximately three-quarters complete. The amphora is dated 1st to early 2nd century. There was also the base and side of a beaker decorated with circles and panels of barbotine dots (F204.1) dated AD 50-90, two sherds of oxidised ware (Fabric DJ) and two sherds of grey ware (Fabric GX; F204.3). A single complete structural nail and two nail fragments (F204.4) are presumably Roman and primary deposits. Intrusive modern pottery and a post-medieval pin in the upper fill can be explained by disturbance caused by the excavation of a modern soakaway or the foundations of Handford House. The cremated bone came from the upper and lower fill of the feature and is from an unsexed adult. The original arrangement of the burial is not known. The absence of a cremation urn (the beaker is unlikely to have held the cremated bone) and the small quantity of cremated bone suggests that the urn has been robbed¹. There was a possible robbing cut showing in section. Presumably the amphora was put in the ground complete and held the cremation urn and beaker. Another Gauloise 4 amphora was found in St John's Street, Colchester in 1986. It had been broken at the shoulder and inverted in the ground, covering a cremation urn (Symonds & Wade 1989, 85). The shoulder of the amphora in F204 was not complete but what remains could have been deliberately broken.

F204.1 (1184), Fig 86, base and side of a beaker decorated with circles and panels of barbotine dots, Cam 100 (Fabric DZ) dated AD 50-90. The form is that of the ring and dot beaker (Greene 1978) and can be dated to the Neronian-Flavian period at Colchester (*CAR 10*, 471-2).

F204.2 (1182, 1183), Fig 87, an almost complete amphora, though with one handle missing, Brockley Hill/Verulamium fabric copy of Gauloise 4 type (*CAR 10*, Type 72-74, Fabric AU), dated overall 1st-early 2nd century, but possibly pre-Flavian (*CAR 10*, 162).

F204.3 (1183), 5 sherds of coarse oxidised ware (Fabric DJ) and two sherds of grey ware (Fabric GX), 1st-early 2nd century.

F204.4 (1182, 1183) 1 complete structural nail and two fragments are presumably Roman and primary deposits, maximum length 34mm.

Urned cremation burial F209, S12 (T125) (Figs 68, 99)

The base of a grey ware jar (F209.1), used as a cremation urn, was found 1.4m below ground-level in a soakaway with no definable cut. It was dated probably 1st-2nd/3rd century and was part of a cremation burial that had been cut away and re-deposited, perhaps during the construction of Handford House. The urn contained cremated bone. All the finds came from within the urn: primary deposits consisted of two hobnails, one structural nail and two shank fragments (F209.5). A melon bead (F209.4) and a shale armet fragment (F209.3) are unburnt secondary deposits, the latter incomplete because of the disturbance to the grave. The diameter of the armet shows that this is the burial of a female child or infant. The melon bead probably dates to mid 1st to early 2nd century. There was also a small quantity of pottery sherds inside the urn (F209.2). The total amount of cremated human bone (all from the base of the urn) is 2.1g. It is the bone of an sexed infant, which accords with the size of the armet.

F209.1 (1194, 1197), base of a jar (Fabric GX) used as a cremation urn, dated probably 1st-2nd/3rd century (not illustrated).

¹ Comment by Howard. Kate discussed elsewhere that there are signs of antiquarian digging around on this site. The missing pot was surely taken out at that time, rather than in antiquity.

F209.2 (1197) small quantity of pottery sherds from a bowl or beaker found inside the urn (Fabric GX).

F209.3 (1196), SF 274, Fig 99, fragment of a small shale armlet of faceted subcircular section. Internal diameter 36 mm, thickness 4 mm, height 5 mm.

F209.4 (1195), SF 273, Fig 99, turquoise frit melon bead. A fragment of an iron nail shank is fixed by corrosion inside the thread hole. Diameter 20 mm, length 15 mm.

F209.5 (1198, 1199, 1200, 1202) SF 276, SF 277, SF 278, two iron hobnails, two nail shanks and one complete nail, maximum length 40 mm.

Possible unurned cremation in L1, T20 (find nos 262 and 264)

A find of 193.3g of cremated human bone in topsoil probably represents an unurned cremation burial moved from its original location. No cut was discernible. The bone was of an adult male.

6.1.2 Pyre debris deposits

It was difficult to differentiate between unurned cremations and pyre debris deposits. F123, F182, F197 and F203 have been listed under cremation burials but may equally be pyre debris deposits. F130 does not contain any cremated bone so cannot be a cremation burial but may be a pyre-debris deposit. There was cremated bone from other layers and features which is likely to have been redeposited from other cremations.

Pyre debris F130, T54 (Fig 37)

A small square pit, cut by F123 and containing occasional burnt stones, charcoal and rare fragments of pot (657, dated as probably 1st-2nd century), ceramic building material and septaria. There was no cremated bone.

6.1.3 Pit containing animal bone

F205 (T119) and F193 (T99) on the northern side of the site are thought to represent a single rubbish-pit at least 3m wide. The bone from F205 contained a butchered juvenile cattle femur and other butchered mammal remains. F193 included the butchered bones of adult sheep and pig, as well as other heavily-butchered large mammal fragments. The feature is located close to both cremation and inhumation burials and may be associated with graveside feasting. Certainly the remains from these fills include good-quality meat-bearing bones and much butchering is evident, suggestive of feasting. The juvenile cattle bone in F205 could suggest that good-quality meat (from younger animals) was consumed. The feature contains a small quantity of Roman pottery including a early 2nd-century sherd.

6.1.4 Metalled areas/road (Figs 69 -71)

Soakaway 3, in the south-western part of the site, revealed a metalled surface which appeared to be cambered, ie it sloped down to the south (F43). The surface consisted of compacted small and medium rounded stones. A portion was taken out by mechanical excavator to expose the feature in section. This showed the metalled surface to be 200-250mm thick, made up of three fills and laid on top of natural sand and gravel. Three sherds of 1st- to 3rd-century pottery were found within the stone surface, including a piece of late 2nd- to early 3rd-century samian. There were also a few pieces of Roman *tegula* just on the surface. There was nothing to indicate that the surface was not Roman.

This metalling was exposed in various other trenches to the north (F43 in T101 and T102), and west (F117 in T45 and T53, F183 in T91, and F194 in T101, T103 and T104) and seemed to follow an east to west alignment. However, it became less compacted to the west and therefore it is not certain if this is a continuous road or discrete areas of metalling. For example in T46/T45 the amphora burial F137 was in the line of the metalling (F117) but the metalling did not survive either side of it. Alternatively what was seen in some trenches could have been a naturally stony layer. In the western-most trenches (T45/T54), the surface became compacted again and appeared to have a camber sloping to the north (F121). If all the areas of stone spreads are parts of the same feature, it would be at least 6m wide and 35m long. It may be that the surface had been truncated at some point in the past, which might account for the looseness of the stone in some places.

F69 in T30 may possibly be a metalled track coming off F43 at right-angles, to the north, or alternatively may just be a gravel spread. F92 in T42 may be a northerly continuation of F69. F69 appears to have two flanking ditches; F65 to its east (T30) and F70/F73/F90 to its west (T30, T28/T41, T40). However, F65 did not continue north as later machining revealed its butt end.

F43 and its continuations west may represent a hollow way rather than a cambered trackway. This is suggested by the tops of most of the cremation burials being higher up (up to 0.38m) than the bottom of the 'camber'. If the metalling were a cambered trackway, the bottom of the camber would be at Roman ground-level, in which case the cremations should be lower down. If it is a hollow way that has been metalled, the top of the 'camber' would actually be at Roman ground-level (see Graph 1).

Previous investigations in the vicinity recorded a Roman road 3m to the north of the find spot of the Facilis tombstone, running through what is now 18 Beverley Road. However, this is too far north of the Handford House site to be the same road.

6.1.5 Ditches

Several large ditches which may be associated with gravel-extraction were exposed in the southern part of the site. One contained cremated human bone and this and others were likely to have been cut through cremation burials. One ditch (F116) cut through the metalled surface (see section 6.1.4). Another contained a 4th-century coin. If the ditches are contemporary then they are likely to be late Roman in date, and dug after the cemetery went out of use. Two smaller ditches of unknown function were recorded in the north of the site:

- F89 Roman ditch running east to west, contains Roman pottery and Trajanic 1st-century coin (finds no 348) (T48).
- F94/F95 Probable gravel-working ditch (F94) with a slot at the base (F95); probably continuation of F89, contained Roman pottery. Fig 72. (T50)
- F98 Large pit or ditch, next to F94 and F89; contained Roman pottery, a 1st-century and a 4th-century coin (Fig 101) and fragments of cremated bone (T49).
- F99 Curved gully with Roman pottery at the base (T37/T38).
- F106 Large pit or ditch with two fills; may be modern as has modern pot in the upper fills, and may be a continuation of F89 as it has a similar shape and fill. Contains Roman glass (T46/T47).
- F110 Large pit, possibly a gravel pit, with three fills, containing butchered animal bone, 1 piece of peg-tile, some Roman pottery and a 4th-century coin (Fig 101); this could be a continuation of F116 and F138 and the peg-tile could be intrusive (T50).
- F116 Large pit which cut metalled Roman road/track F117, contained one sherd of amphora (T53)
- F122 Ditch or gravel pit with two fills; could be same as F106, may be modern; contained Roman pottery (T46).
- F138 Ditch, may be a continuation of F110 and F116 (T45).
- F160 Ditch cutting inhumation F171; no finds (T62/66).
- F164 Ditch cutting F163, not dug (T62).

6.1.6 Small ditches and pits

Several small ditches and pits of Roman date were recorded across the site. None of the ditches were obviously cemetery boundaries, but some could have been:

- F2 Narrow north-south ditch containing a Roman early 3rd-century coin (finds no 16), and a late Bronze Age or Roman flint flake, plus Roman tile. It cannot be a cemetery plot boundary as it runs straight towards a Roman inhumation (F1) and is probably too late in date to be cremation cemetery boundary (T4).
- F5 Narrow ditch, aligned roughly north to south, parallel to F2, containing a Roman mid 3rd-century coin (19) and Roman early 2nd-century or later pottery (T4).
- F6 Very shallow ditch with two sherds of 2nd-century pottery and one piece of slate; may be modern (T4).
- F100 Small pit containing Roman pottery, tile and charcoal fragments (T56a).
- F104 Pit containing most of a flagon but no cremated bone. This is possibly a cremation burial which had been partially destroyed, perhaps by modern gardening. Also contained a large convex counter made from a sherd of a grey ware latticed jar; (Fig 73, SF 198. (417)). (T37).
- F125 Pit cutting inhumation F119, contains Roman glass (T21).
- F156 Pit containing Roman pottery, one hobnail, Roman tile and an iron object (T56b).
- F163 Shallow pit cutting ditch F160, and containing Roman pottery and tile (T62).

- F188 Shallow ditch aligned east to west, containing Roman pottery (T79).
F202 North-to-south-aligned ditch, containing charcoal fragments, pottery, brick and bone fragments (S6).
F207 Square-sided pit containing a small amount of uncremated bone and one piece of samian pottery; perhaps cut by inhumation F171 (T66).

6.1.7 Stake holes

Six stake holes were recorded in T11 (F21-F26). These appeared to cut cremation burial F19 as cremated bone from F19 was present in stake holes F21, F24 and F26. The stake holes may have supported grave markers as at London's eastern cemetery (Barber & Bowsher 2000, 109).

6.1.8 Structures

F185, a narrow ditch containing large pieces of Roman tile, stone and mortar was the only Roman feature containing structural elements (T81).

6.2 Post-medieval and modern features

(modern drains and service trenches are not included)

In the north-eastern part of the site, the foundations of a 19th-century greenhouse/vinery building were exposed during the excavation of a service trench (T169). This consisted of a row of six modern brick piers aligned east to west (F153) with brick rubble in between and to the south (F150). The brick rubble consisted mainly of yellowish brown silty sand and frogged bricks, but there was also some Roman brick and tile and pieces of Roman amphora. Mixed in with the brick and tile was modern glass, china, slate and clay pipe. The row of piers represented the northern edge of the temporary building marked on the 1876 OS map. The southern edge was not found, probably because it was missed by the service trench. Sale documents of Handford House ('Gafwell House') in 1892 list a vinery, 31ft by 13 ft, fitted with heating apparatus (ERO D/DEL T198). These dimensions concur with what was found by the excavation. The brick rubble and sand was used to regulate drainage and humidity necessary for growing vines.

Throughout the excavation, areas of disturbed ground were encountered which all had similar fills consisting of grey brown loose sandy silt with diagonal bands ('tip lines') of yellowish orange stony sand (Fig 74). The fills and the modern finds within indicate that they were dug in the 19th century and had been backfilled deliberately. The depth of the disturbance was between 800mm and 1m below ground-level. Although all these areas of disturbance were given separate feature numbers, it later became apparent that they made up two large trenches and one small trench (fig 5). In the north-eastern part of the site, a trench at least 33m by 10m had been dug. This covered much of the area of plots 15 and 16, the detached garage block to the west and the service trench in between. A second large trench approximately 15m by 18m was recorded to the south. This affected most of the area of plots 10, 12 and 14. On the western side of the site, a small area trench was recorded in T89 and T90 of the garage block. The fills contained 19th- or 20th-century pottery, slate, clay pipe and peg-tile. In some of these features there was Roman pottery and tile and also cremated bone. These trenches occasionally truncated inhumation burials; for example, two skulls were found in two of them (F8 and L36). Usually, however, these trenches were not dug deep enough to disturb the inhumation burials. Where the edge of one of these trenches was visible (F55), it was seen to be straight-sided.

These trenches are thought to be excavation trenches dug by employees of the antiquarian George Joslin who lived opposite at 10 Beverley Road. He is known to have excavated a large number of urned cremations from this vicinity in the 1860s and 1870s (see section 3.2 and *CAR* 9, 259). However, excavating such a large area would have been a big undertaking for an amateur archaeologist and we do not know of Joslin actually instigating large-scale excavations, only making records of artefacts found during groundworks that were taking place. It may be that these large trenches were gravel quarries, dug before Handford House was built (in 1859). But gravel quarries would probably have been deeper than 1m and are unlikely to be straight-sided.

These excavation trenches were seen to be cut by the piers for the vinery/greenhouse, thus pre-dating this structure. All the cremations in these disturbed areas had been removed thus making the original density of cremations even higher than it appears in the current fieldwork.

Other modern features may be gravel-extraction pits which are known to have been dug in the gardens here (James Fawn, pers comm). Additionally, in the area of T3, T4, T5, T7 and T9 (plots 15-16), there had been a very large tree which was blown down in the 1987 gales. The tree bowl was filled back in again and may account for some of the disturbance. The remaining

post-medieval and modern pits and features are listed below, some contain residual Roman artefacts:

- F34 – a modern or late post-medieval pit cutting cremation burial F36, contains willow pattern pottery, clay pipe and Roman glass fragment (T13)
- F39 – a post-medieval pit cutting inhumation F31 (T8).
- F68 – modern ditch (T32).
- F80 – post-medieval or modern ditch containing a small amount of animal bone, clay pipe and two pieces of residual Roman pottery and Late Iron Age/Early Bronze Age pottery (T34).
- F58/F91/F55 – modern pit, part of probable 19th-century excavation trench, containing a Roman pewter base sherd (not drawn); SF243 (358), F91, from a plate or dish with low V-section footring, minimum diameter 130 mm. Probably a grave deposit (T19, T22, T24, T26, T27).
- F96 / F74 – modern ditch containing an early Roman copper-alloy swan's head handle terminal (Fig 100, SF 48(363)); also contained porcelain (T27).
- F105 – post-medieval pit cutting cremation burial F101/107 (T38)
- F124 – pit containing modern glass (T54).
- F144 – ditch or pit containing peg-tile fragments, clay pipe and post-medieval pottery (T56b).
- F145 – ditch containing peg-tile (T56b).
- F152 – small ditch running east to west containing tile, peg-tile and a Roman glass fragment plus probable late Roman copper-alloy finger-ring fragment (Fig 100, SF 104. (787)) plus a small quantity of animal bone (T56b).
- F157 – small pit seen in section only, cutting modern trench fill F155 (T61).
- F166 – large probable gravel pit filled with topsoil-like material, at least 2.2m deep, containing modern pottery (T70/T73).
- F167 – large, deep pit or ditch containing a fragmented grey ware urn; feature must have cut through a cremation burial (T71).
- F177 – cut feature containing two medieval or post-medieval pins (T59).
- F187 – shallow wide ditch containing Roman tile and pottery and post-medieval or modern brick (T78).
- F189 – shallow cut feature containing 17th-century pottery, may be part of general ground disturbance (T88).
- F196 – roadside ditch to road F43 or a post-medieval or modern layer sealing F43 (T102).
- F206 – pit or cellar (soakaway), possibly part of former Handford House building (T119).

6.3 Undated features

Several undated features on the site are listed below:

- F48 – ditch or pit (T16).
- F50 – possible ditch (T16).
- F51 – ditch, V-shaped, possibly continuation of F50, contains fragment of Roman glass (T14).
- F54 – pit cutting F47, containing one sherd of mid Roman pottery and a fragment of iron sheet, Maximum dimensions 26 by 21 mm, (SF 181. (210)) (T15).
- F61 – small pit (T26).
- F66 – cut feature (T23).
- F75 – pit (T35).
- F109 – linear east-west feature with a Neolithic flint blade in its upper fill, may be natural (T37).
- F111 – pit containing Roman pottery, cremated bone and charcoal (T47).
- F112 – pit or linear containing undated brick or tile (T47).
- F127 – small ditch cutting Roman road F117, fig 71 (T45/T53).
- F136 – straight-sided ditch (T54).
- F139 – small pit (T47).
- F140 – shallow ditch (T54).
- F143 – ditch (T39).
- F146 – pit containing fragments of cremated bone and a post-medieval copper-alloy object (T56b/T57).
- F148 – pit next to F146 (T56b/T57).

F174 – narrow linear feature aligned east to west, containing small amount of Roman pottery (T75).

F175 – natural linear feature (T75).

F191 – small ditch with two fills (T80).

7 Finds

7.1 Roman pottery

by Stephen Benfield

Introduction

In this report, Roman pottery vessel form numbers follow those of the Camulodunum (Cam) Roman pottery type series (Hawkes & Hull 1947; Hull 1958). Roman pottery present at Handford House are listed in Table 12. Vessel types are listed in Table 27 (Appendix 1), and there is a full catalogue of Roman pottery (Table 26, in Appendix 1).

Table 12: Roman pottery fabric codes and corresponding CAR 10 fabric names used in this report.

Fabric code	Fabric name
AA	amphoras, all excluding Dressel 20 and Brockley Hill/Verulamium region amphoras
AJ	amphoras, Dressel 20
AU	miscellaneous amphoras including possible Brockley Hill/ Verulamium
BA	plain samian forms
EG	East Gaulish plain samian
CH	oxidised Hadham wares
CB	Colchester red colour-coated roughcast wares
CZ	Colchester and other red colour-coated wares
DJ	coarse oxidised and related wares
DZ	fine oxidised wares
EA	Nene Valley colour-coated wares
EB	Lyon colour-coated ware
FJ	Brockley Hill/Verulamium region oxidised ware
GA	BB1: black-burnished ware, category 1
GB	BB2: black-burnished ware, category 2
GP	fine grey wares (Colchester, London-type and north Kent wares)
GX	other coarse wares, principally locally-produced grey wares
HD	shell-tempered and calcite-gritted wares
HZ	large storage jars and other vessels in heavily-tempered grey wares
KX	5 black-burnished ware (BB2) types in pale grey ware
UR	terra nigra-type wares

Pottery from inhumation burials

Three partial pots came from inhumation burials F1, F154 and F208, and late Roman potsherds came from the backfill of two burials (F31 and F159). The upper part of a Cam 266 jar (F154.1) of 1st- to early 2nd-century date was associated with inhumation burial F154. A flagon (F1.1, minus neck and top), dated 1st-2nd century, came from the lower fill of burial F1. Also an almost complete but fragmented jar of form Cam 268 (F208.1), dated early/mid 2nd to late 3rd/early 4th century, was associated with the jumbled inhumation burial F208. The sherds from fills of F31 and F159 were early-mid 3rd- to 4th- and 4th-century date.

Pottery from cremation burials

Pottery ranging from whole pots, to sherd groups representing part of a pot, or just a few pot sherds, was recovered from 52 (approximately 90%) of the 57 cremation burials. These cremation burials include three possible pyre-debris deposits. Small numbers of sherds were also recovered from two *busta* (F47 & F134). A number of the burials had suffered disturbance so that the condition and completeness of the pottery burial assemblages varied, and the overall number of pots included with all the burials can only be approximated. The pottery types associated with each cremation burial and date of the pottery from each burial is summarised in Table 27 (Appendix 1).

Date of the pottery from the cremations

Of the individual pots or pottery groups from the cremation burials (including pyre-debris deposits), 26 can be dated to the 1st-early 2nd century, of which nine include pottery which is pre-Flavian. A further

seven cremation burials can only be dated generally to the 1st-2nd century. Pottery from 15 cremation burials can be dated to between the earlier 2nd century and the mid-late 3rd/early 4th century. Of these, pottery from six is of early or mid 2nd- to early 3rd-century date. Pottery typical of the late Roman period appears with only two cremation burials, ie F113 and F88. There are two partial pots (F113.1 & F113.2), which are jars in Fabric GA of form Cam 279C, dated early-mid 3rd-4th century, from F113. Sherds also of form Cam 279C came from the disturbed cremation burial F88.

Pottery vessel types and number of pots from the cremations

Of the cremation burials, 22 contained one pottery vessel, although with three of these burials there was also a pottery lid for the cremation urn, and, in addition, in one instance the lower part of another pot had been used as a lid for the urn. Also, in eight burials there was one pot, together with a few sherds from other pots which may be residual. Overall this gives a total of somewhere between about 40% and 50% of all cremations accompanied by a single pot or single pot provided with a lid. This single pot was almost always a jar, although, in a few cases, a tall bowl of similar proportions to a jar (jar/bowl) had been used. Within the burials (even when a number of pots were present), the jar was almost always used as the container for the cremated bone. Only possibly in one instance was a pot type other than a jar or jar/bowl used to contain cremated bone. This was a flagon from the burial F41 (F41.1), and it was the only pot recovered from this burial.

Of the remaining cremation burials, ten contained two pots, while in another four burials, two pots were represented in each by sherds only, so that between about 20% and 25% of all the cremation burials were accompanied by two pots. In these burials, the usual combinations of pots were a jar with a flagon (four burials), a jar with a beaker (two burials), or a jar with a dish (one burial). Only in two of these burials was a jar or jar/bowl absent (F45 & F204), and here the combination was a flagon with dish (F45) and a beaker with amphora (F204), although it should be noted that F204 had been disturbed.

Only a few (just under 10%) of the burials contained more than two pots. Burials F162 and F165 contained three pots. F162 contained a jar (with a lid), a flagon and a beaker, and F165 contained a jar, a beaker and a dish. Burial F53 contained three (possibly four) pots, a jar and a dish (both whole), much of a flagon (broken and used to shield a lamp), and sherds from a second flagon. Three whole pots came from burial F42; a jar, a flagon and a small bowl. However, there were parts of two other pots in F42, ie a flagon (large sherd) and a beaker (partial pot), which were both deliberately placed in the grave to shield a lamp. There were five pots with one burial (F137), although one of the pots, a Dressel 20 amphora (F137.1), was used as a container for the burial group. The upper part of the amphora had been detached to allow access to the interior. The pottery vessels inside the amphora consisted of a jar, a flagon, a dish and a beaker (F137.2-F137.5).

One other burial contained an amphora. This was the disturbed cremation burial F204 which contained an amphora of Gauloise 4 type from the Brockley Hill-Verulamium region potteries (Fabric AU). The amphora (F204.2) was recovered as sherds and is probably about 75% complete with parts of all the pot present, although only about 50% of the base is present. It seems probable that the amphora was used as a whole pot within the context of the burial, possibly as a container for the cremation burial, as with a similar Gauloise 4 amphora used in a cremation burial from St John's Street in Colchester (CAR 10, fig 3.7, 140). In that case, the amphora would have had to be cut in two, with the upper part (neck, handles and shoulder) being detached from the body to allow access to place the cremation inside. However, the very broken condition of the Gauloise amphora from the Handford House site means that it is not known if the upper part had been detached to allow it to be used as a container for the cremation burial or not. The only other pot associated with the burial was the lower part of a ring and dot beaker (F204.1).

Burial F19, which had been disturbed, appeared unusual in that it contained parts of three *tazze* (F19.1-F19.3), one of the *tazza* being represented only by sherds making up the base of bowl and top of the foot stand, as well as a few sherds of uncertain status from five other pots.

Damaged pottery

Many of the pots were broken or partial so that in most cases any deliberate damage was not identifiable. No deliberate damage was recorded for any of the whole pots recovered, although it appears that the flagon (F53.2) in burial F53, sherds of which were used to cover the lamp, may have been deliberately broken for that purpose. Also there was no evidence of any other parts of the pots

represented by the beaker base (F42.5) and flagon sherd (F42.4) used for the same purpose of shielding the lamp in burial F42. Here suitable remnant pieces of broken pot may simply have been made use of. However, the sacrifice of two otherwise unattested pottery vessels associated with the cremation may be more likely. There is a correspondence between the small vessel (bowl) and flagon, both whole grave goods placed with the cremation urn in F42, and the small beaker base and flagon sherd covering the lamp, possibly suggesting two sets of grave pots, one set of which was broken and the sherds used in the burial.

The most common damage recorded on pots and pot sherds was evidence of burning. Nine burials contained burnt sherds (F19, F36, F53, F141, F142, F180, F182, F186, F199). Although the tazza in F19 could possibly have been scorched or burnt during use, as tazze are commonly thought of as incense burners, some sherds appear to have been heated in such a way as to suggest that the pots had been burnt. Some residual sherds from the fill of the inhumation burial F1 were also burnt. It might be, however, that much or all of the pottery from the *bustum* F47 was burnt, although this was probably not the case with *bustum* F134. From F47, of the eight medium- to small-sized sherds recovered, only two sherds, both from the same grey ware pot, are clearly burnt. Of the pottery recovered from F134, a broken cream oxidised ware flagon (F134.6) overall shows little sign of having been scorched or burnt, although a few sherds from this pot are slightly discoloured grey. This discolouration could be caused by burning, although it is not clear if these sherds have been burnt. Also, amongst a small quantity of sherds of white oxidised ware from F134 (F134.7), probably from another flagon, a few are also discoloured grey with the same appearance as those from the flagon F134.6. Again it is not clear if these sherds have been burnt.

Firing defects indicating kiln-damaged pots, either serviceable kiln seconds or wasters, were much rarer than burnt sherds. There are two pots (F87.1 & F201.1) with heat damage which could be burning or a kiln defect from firing. The pot F201.1 also has a manufacturing blemish on its shoulder which might suggest that it is a kiln second. The only other example of a physical defect noted on a pot was the distorted rim of pot F15.1. Also the oxidised jar (F128.2) from burial F128 may be mis-fired grey ware and thus a second or waster pot.

Discussion

Only a small quantity of pottery was associated with the inhumation burials; however, the wide date range of the pottery associated with them - 1st-early 2nd to late 3rd-4th century - deserves some comment. While sherds from the backfill of two burials (F31 & F159) are early-mid 3rd-4th or 4th century, and these are clearly late Roman inhumations, partial pots associated with two other burials are of 1st- to 2nd-century date. The pot from burial F1, an incomplete local flagon of 1st- to 2nd-century date, came from the lower fill of the grave cut. Also, an incomplete and broken jar of form Cam 266, dated 1st-2nd century, came from the mid back area of the skeleton in F154, and could have been below the burial in the grave cut. Both the positions in the burial (one in the grave fill and one possibly below the inhumation) and also the incompleteness of the pots suggest that they may be residual. Also both pots are of pottery types common among the cremation burials from the site. The only other pottery associated with an inhumation is a broken Cam 268 jar, of mid to late Roman date (early/mid 2nd to late 3rd/early 4th century) from burial F208. Overall, although pottery associated with the inhumation burials dates from both the early and later Roman periods, the early Roman pottery associated with two inhumation burials may be residual, and it is possible that the inhumation burials are all of the late Roman period. It can be noted that, other than the late Roman pottery sherds from the fills of inhumation burials F31 and F159, the only other recognised late Roman pottery from the site are two partial jars (from F113) and a few sherds (from F88) of early-mid 3rd- to 4th-century date (see below).

The pottery from the cremation burials suggests that about two-thirds of the 57 recorded cremation burials are of 1st- to 2nd-century date. Of these, nine contained pottery which can be dated as pre-Flavian, and it is probable that most, if not all, of these nine burials are pre-Boudican. Of the remaining one-third (approximately) of the cremation burials, the pottery from these is almost all of 2nd- to 3rd-century date. The only late Roman pottery consists of a few sherds in BB1 (Fabric GA) of the jar form Cam 279C (early-mid 3rd-4th century) which are intrusive in the cremation burial F88, and two partial jars also in BB1 (Fabric GA) both of jar form Cam 279C from the cremation burial/pyre-debris deposit F113.

Overall, the pottery associated with the cremation burials is generally in accord with the types of pottery vessels, numbers of pots and prevalent use of jars as cremation urns, as recovered and

recorded from Roman cremation burials in the south-east of England (Philpott 1991, 35-6). This appears also to be reflected in the pottery from the two *busta* (F47 & F134) with grey ware sherds, probably from jars or bowls, and other sherds probably from flagons, represented.

The use of pot sherds to cover and protect lamps (F42 & F53) deserves mention. In cremation burial F53, much of a Brockley Hill/Verulamium region flagon (F53.2) was placed so that the broken neck and rim created a chimney effect above the lamp. With this (as would usually be expected) was a jar containing the collected cremated bone. The matching of a jar, used as a cremation urn, and flagon, is one of the two most common combinations in cremation burials, the other being jar and beaker (Philpott 1991, 35), and it appears that, in cremation burial F53, the flagon may have been sacrificed to cover the lamp. In the cremation burial F42, a similar arrangement of broken pottery to shield the lamp had been made, although here the broken pottery was a large sherd from a flagon (F42.4) and a beaker base (F42.5). An intact flagon (F42.3) was placed next to the cremation urn, and a small bowl (F42.2) was also present as part of the grave group. No other sherds were present in the burial from the two broken pots (beaker and flagon sherd) used for shielding the lamp, and suitable remnants of broken pot may simply have been made use of, although it seems unlikely that these would simply have been to hand. Perhaps more likely is that they were brought to the funeral as part of a larger group of pottery. The pottery from the cremation burial could be seen as an original group of a cremation urn with a flagon and small bowl which were used to form the set of grave goods, and other pottery, possibly representing a second set of grave goods of a flagon and beaker, which were sacrificed to cover the lamp.

Of the pottery itself, two individual pots are of intrinsic interest. One is an amphora (F204.2) of Gauloise 4 type, a copy in fabric of the Brockley Hill/Verulamium region (Fabric AU) from the disturbed cremation burial F204. The amphora was recovered as sherds and is about two-thirds complete. A ring and dot beaker (F204.1) associated with it suggests a Neronian-Flavian date for the burial. Amphoras in Brockley Hill/Verulamium region fabric have been recognised from excavations in Colchester (*CAR 10*, 162-4). The most easily recognised were of form Dressel 2-4, and much of these came from early military/colonia contexts (dated c AD 44-49/55) on the Lion Walk site (*CAR 10*, 162). However, copies of Gauloise-type amphora forms have been recognised with about half a dozen examples 'previously recorded from Colchester' (*CAR 10*, fig 3.19, 18-22). More generally, copies of Gauloise amphora forms from the Brockley Hill/Verulamium region potteries have been discussed by R P Symonds, the largest number of these pots being recorded from London (Symonds 2003, 54-5). The second pot of intrinsic interest in relation to Colchester is a beaker in white eggshell ware of Marsh Type 11 (Marsh 1978) from cremation burial F192. The form is absent or very rare at Colchester with no examples in the Camulodunum type series or published examples in *CAR 10*. A number of these pots have come from pits dated to the early 2nd century in London (Marsh 1978, 146). It can be noted that the amphora from cremation burial F204, and the beaker from F195 which is rare or unique to Colchester, are both pots which are recorded more frequently from London.

7.2 Samian pottery

by Joanna Bird

Table 13: List of samian pottery by context.

Find no	Context	Description	Date
21	L2, T5	Drag 27, South Gaul; burnt	Neronian-early Flavian
91	F34, T13	Cup, probably Drag 27, South Gaul; slightly burnt	Neronian-early Flavian
149	F43, S3	Drag 45 mortarium, East Gaul (Trier); abraded	late 2nd-first half of 3rd c
156	L1, T15	Bowl/dish, Central Gaul	Hadrianic-Antonine
204 F47.7	F47, T15	Drag 31 or 31R (Ludowici Sa or Sb), East Gaul (Trier)	later 2nd-early 3rd century
407	L1, T38	Drag 33, Central Gaul	Antonine
794	F151, T60	Drag 31R, Central Gaul; slightly burnt	mid-late Antonine
888	U/s, T67	Drag 30 or 37, probably East Gaul (Rheinzaubern) though origin at Colchester is not impossible	later 2nd-first half of 3rd c
926	L3, T72	Bowl/dish, Central Gaul	Hadrianic-Antonine
1004 F141.6	F141, T94	Cup, probably Drag 27, South Gaul; burnt	Neronian-Flavian
1015	L1/2, T79	Drag 37, Central Gaul. Panel design with wavy-line borders, including small figures, one of them probably a gladiator (cf Oswald 1936-37, type 1056)	Hadrianic-early Antonine
1190	F207, T67	Drag 15/17, South Gaul	pre-Flavian

Drag = Dragendorff forms Antonine = AD 138-192 Flavian = AD 69-96
 Hadrianic = AD 117-13 Neronian = AD 54-68

7.3 Small finds and bulk metalwork

by N Crummy

The coins (Table 28 in Appendix 2)

Table 28 in Appendix 2 lists the coins from burials first, followed by those from other site features, and layers, and finally unstratified items. The first column gives the small find (SF) number, the next four the find number, feature or layer number, and context description. The coin identification, diameter, weight, reference, and date follow, with the final column giving the coin period defined by Reece (2002, 145).

All the coins from the site are of Roman date apart from a 1936 penny of George V from topsoil (L1) in T68. The Roman coins range in date from Claudius (AD 41-54) to Honorius (AD 395-402), but are too few in number to be used statistically.

Eight burials contained seven coins; three are burnt pyre deposits (F47, F134 and F199), the others are unburnt burial deposits (F42/F53, F44, F197 and F198). The use of single coins points to their being fees for Charon the ferryman, who bore the souls of the departed across the river Styx to the underworld. Two are illegible but early Roman (F42/F53, F47), most are Flavian (F197 and F199, Vespasian; F44, Titus; and F134, Domitian), and one dates to early in the reign of Antoninus Pius (F198). The coin of Titus is in very good condition and is unlikely to have been in circulation for any length of time before being deposited, but the longevity of Antonine *aes* means that the coin in F198 may have been deposited many years after its date of minting. The absence of pre-Flavian, Trajanic and Hadrianic coins might be taken to suggest that the area was used for burials in two distinct phases, but several burials contained pre-Boudican/pre-Flavian lamps, and the low number of graves producing coins suggests that the pattern of deposition is more likely to be a reflection of family practice rather than of cemetery usage.

Family practice is demonstrated very clearly in two of the eight burials (F42 and F53), each of which contained one half of a single coin (Fig 88). It is a very worn and illegible as of 1st-century date which was first of all scored or struck many times on one face, with most of the incisions concentrated close together and therefore weakening the metal at that point, and was then struck once on the opposite side along the same line, causing the coin to split into two. This use of a single coin implies an extremely close relationship between the people buried in the two graves, a relationship also demonstrated by the close proximity of the two features and the similarity of the burial rite and the other grave deposits (see sections 7.4 and 7.9).

The possibility has been considered that the choice of coins deposited with the Handford House site burials was dependent upon the reverse being in some way pertinent to a funerary context. The reverse image is visible on five of the eight: *Spes* in F44, the emperor, probably holding a *palladium*, in F134, *Securitas* in F197, *Salus* in F198, and *Victory* in F199. All four female personifications can be interpreted as appropriate statements of the thoughts and wishes of a family for a member who has departed to the afterlife: *Spes* is hope, *Securitas* is confidence/security, *Salus* is safety/health, and *Victory* is the triumph of life everlasting in the underworld over death. The reverse of the emperor with a *palladium* may also be appropriate, as the image is at once imperial and priestly, and the *palladium* invokes *Pallas Athene/Minerva* as both a safeguard and a figure of courage and victory. All the images may also be seen as protective in the context of the journey to the underworld.

Proving deliberate selection based on the reverse image depends on amassing statistical evidence that the reverses found in graves differ from those found on occupation sites. This is not an appropriate undertaking in the context of this report, and will be particularly difficult from published coin lists, as they rarely give the reverse image and rarely state which edition of *Roman Imperial Coinage* was used, which might allow the image to be found through the reference. However, taking the *Securitas Augusti* reverse on coins of Vespasian as a sample, comparison with two recent large excavations at Colchester and with the Forum-Basilica site at Silchester suggests that this reverse occurs infrequently. Twelve Vespasianic coins were found at Silchester, of which only one had *Securitas* on the reverse (Boon 2000, 138-9). Of the 32 Vespasianic coins coming from two Colchester sites - sixteen each from the 29-39 Head Street site (CAT Report 268) and the St Mary's hospital site (CAT Report 484 forthcoming) - only two had *Securitas* on the reverse, while eight (25 %) had the eagle on globe reverse. These figures cannot be regarded as absolute, however, as the reverses of five of the coins from the 29-39 Head Street site and three of those from the St Mary's hospital site were illegible (CAT Report 268, 25-8; CAT Report 484 forthcoming).

Some of the coins from features other than graves at the Handford House site are likely to be disturbed pyre or grave deposits. One of these, a *denarius* of Septimius Severus from ditch F2, possibly scorched, is worth noting in the context of funerary symbolism. The reverse is *Indulgentia Aug in Carth*, which shows the sky-goddess *Dea Caelestis* seated on a lion running beside a stream. The sky-goddess is linked to the solar wheel and thus represents rebirth, the stream is emblematic of the water of life and perhaps also a reminder of the river Styx at the junction between life and death, while the lion not only represents the all-devouring jaws of death but may also be the guardian of the dead. It appears on tombstones and as small objects in graves, including a coin of Philip I with a lion reverse, pierced so that the lion image, not the bust of the emperor, was upright when suspended (Toynbee 1971, 192; R/B I nos 121 and 201; Bertrand 2003, 64, fig 68; Henig & Wickenden 1988, 107; Hagen 1937, Taf 40, J9).

Many of the other coins from the site may also derive from disturbed burials, but none show signs of being heat-affected. Other characteristics of the assemblage include: 1) an absence of barbarous radiates, which often occur in very high numbers on urban sites but low ones on suburban/rural sites (eg *CAR 4*, table 8, 22, 44-9); 2) a good proportion of Constantinian coins of Reece's period 17, a time of general high coin loss; and 3) the presence of a coin of Honorius (AD 395-402), examples of which are comparatively rare, particularly in small assemblages such as this. The first two suggest the assemblage conforms to the general pattern for suburban/rural sites in Roman Britain.

Pyre-debris deposits and cremation burial deposits (Table 29 in Appendix 2)

Following the distinction used by Bel (2002), the objects recovered from cremation burials are here described as primary deposits if they are small refrozen fragments of pyre debris, show clear signs of having been scorched, or are fragmentary (but not necessarily burnt), and as secondary deposits if they are complete and unaffected by fire. The difference cannot always be determined with certainty, and evidence from at least one of the funerary features (F134) suggests that secondary grave goods can be added to a *bustum* after the ashes had cooled. Distinguishing between incomplete primary deposits and residual items is rarely possible, but there seems to be little residual material in general in the Roman levels. Coins are also briefly listed; they are discussed and catalogued in detail above. Similarly, the lamps are briefly listed here but are described and discussed by Hella Eckardt in section 7.4. Iron nails, other than hobnails, are of Manning's Type 1b, with more or less flat round head (Manning 1985, 134).

Table 29 presents the primary and secondary deposits among the small finds and bulk metalwork from the cremation burials and other early funerary features. Structural nails have been found in many of the cremation burials but are not shown in the table. They may have come from the funerary bed or bier, or may have been used in the construction of the pyre itself, or may have been fixed in timber from demolished buildings used as fuel, while the smaller examples may have come from boxes or similar small wooden objects placed on the pyre as grave goods. Where boxes have been deposited as secondary grave goods they are shown in Table 29.

The most frequently recovered grave goods are hobnails from nailed footwear. A maximum of 26 cremation burials, out of 57 from the site, produced hobnails, and the high number of disturbed cremation burials means that the true figure is likely to be much higher. However, in F15, F179 and F192, undisturbed burials with only one or two hobnails, they may be residual. Very large numbers of hobnails in cremation burials suggest that the burnt shoes had Rhodes' Type C close-set nailing pattern, where a lines of nails ran around the outside edge and the inner area was filled with rows of nails (1980, 107). As this nailing pattern appears to be restricted to adult shoes, then the individuals buried in F115 and F203 (at least) can be presumed to be adult.

The suggestion has often been made that shoes were deposited in burials as symbols of the journey to the afterlife, but contemporary written evidence provides a much simpler reason, the dead were burned on the pyre fully clothed (Toynbee 1971, 44-50). The high proportion of nailed footwear in the Handford House site cremations shows that the early Roman population of Colchester conformed to that practice. Because not all footwear was nailed and in some cremations very little pyre debris had been collected for burial, the absence of hobnails from some of the graves need not represent an absence of footwear on the pyre, but an indication that thonged or 'stitched-only' sandals were worn, or that the random collection of pyre debris had failed to include hobnails. However, it is possible that footwear might have been missing from some burials, in particular those where the rite differed in some way from the norm of placing the ashes in a ceramic vessel. For example, in F120 the bones

were placed in a jewellery box and the only other item in the grave was a small accessory vessel, and in F126 the bones lay in a glass jar which was itself within a wooden box.

Coins and lamps are fairly well represented; the former are discussed above, the latter in section 7.4. The high number of lamps that can be shown to have been lit when deposited is an important feature of the site, and suggests that much information of this type was lost during the 19th-century excavations in the area. The images on the coins may have influenced their selection as grave deposits, and the two complete picture lamps from burials certainly bear strikingly apotropaic designs, one shows a lion fighting a crocodile (F42, Fig 88), the other a stave dancer with large phallus (F53, Fig 89). A lion occurs on the site on a coin from a disturbed funerary feature, and its imagery has been summarised above. The lamp shows the crocodile as representing the dangers of the afterlife, which are held at bay by the attacking lion. The phallic image on the lamp from F53 would have been selected as a means of averting the evil eye (Johns 1982, 61-75). Young boys in Republican Rome wore phallic amulets to guard them from danger as they grew up, and small gold rings with a phallus on the bezel from London and from Faversham, Kent, and a small gold phallic pendant from Braintree, Essex, belong to this tradition (Varro, *de lingua latina*, II, 97; Henig 1984, fig 92; Johns 1982, pl 10; Johns 1996, fig 1.3; Johns & Wise 2003), while phalli of various materials have been found in children's graves in Britain (eg *CAR* 9, 41; Lentowicz 2002, 68, fig 260).

It is difficult to be certain that two incomplete picture lamps, from F141 and F199, were deliberate primary deposits rather than residual. Both burials also contained factory lamps of later date, which supports the idea that the picture lamp sherds are residual. However, there is in general little residual material in the cremation graves and it may be that these picture lamps had been decorated with apotropaic images like those from F42 and F53 and their potency had been invoked by deliberate breakage at an earlier stage in the burial rite. Alternatively, as neither group of sherds has been burnt, their inclusion in the burials may represent the provision of a ritually-killed lamp for the soul on its journey to the underworld, while the complete lamps, both placed in the grave alight, were provision for its departure from this one. The choice of the newer lamps for lighting and the older for breaking may therefore contain an element of conspicuous consumption.

Fragments of a picture lamp and of a pipeclay *aedicula* came from the disturbed burial F19 (Fig 88). The fabric of the lamp appears slightly discoloured and it may have been burnt, but the *aedicula* fragments are unburnt. Too little remains of the latter to attribute it to a particular type, so the deity it contained is unknown, but it represents another instance of including a protective image in the burial.

One burial, F120, contained a jewellery box of a well-known 1st-century type which used rings as both hinges and strap-guides (Figs 91-92). This box was a secondary deposit containing cremated remains, but in F36 (Fig 88) and F101/F107 only a fragment of a ring picked from the pyre debris is present, although F101/F107 also contained a fragment of a bead representing the box contents. Boxes of this form were used in life for the storage of jewellery, clothing, or toiletries, and their fittings have been found on occupation sites both on the Continent and in Britain (Riha 2001; *CAR* 6, 165-6; Wilson 1968, pl 45, 193). Examples from early Roman burials in Britain are concentrated in the south and east, with the majority coming from Essex and Hertfordshire, but they were not always used to hold the ashes (Borrill 1981, table 46; Philpott 1991, table A4). In F199 several fragmentary copper-alloy box fittings (Fig 99) were associated in the burial-pit with pyre debris, but the box may not have been of the same type as those in F120, F36 and F101/F107. Another jewellery box may have been associated with F41, which contained small nails similar to those from the box in F120.

Sturdier boxes made with thicker wooden boards than that in F120, lay in F126 (Fig 92) and F108. They may have been purpose-made 'cremation coffins', or household storage boxes appropriated for the burial.

Jewellery came from only four cremation graves, F45, F101/F107, F162 and the disturbed pot base F209. A single bone bead fragment came from F45 (Fig 89); F101/F107 (Fig 90) held only a fragment of an eyed bead, almost certainly a primary deposit, while F162 contained a melon bead, an ivory armband and a copper-alloy finger-ring (Fig 97), and F209 contained a melon bead and part of a shale armband (Fig 99). The objects from F162 and F209 are secondary deposits. Melon beads are post-conquest imports, and the eyed bead is also post-conquest and probably an import. Although melon beads are a long-lived form, they were not necessarily regularly imported into Britain. Examination of the contexts producing melon beads from the 1970s excavations in Colchester shows that 73 per cent came from pre-Trajanic contexts, and many of the remainder came from contexts with a high level of

residual pre-Trajanic material. Moreover, no melon beads at all came from sites without 1st-century occupation.

Three graves produced mirrors, ie F128, F134 and F200. A different form was present in each burial. In F128 the mirror was small and round, and was made of a low-tin bronze, not the more common high-tin bronze (*speculum*) used for the other two (Fig 92). The mirror in F200 was small and square or rectangular (Fig 99), while a handled round mirror came from F 134 (Figs 95-96; Plates 7a-7b). All three mirrors were unburnt secondary deposits, even that in F 134. A spoon was also deposited in F134 and, as it was associated with a mirror, may have been used as a toilet instrument rather than an eating utensil (Fig 94).

The urned cremation burial F53 contained the head of a burnt bone needle, and a bone shaft found in the same grave probably also belongs to the needle, although there is some chance that it may instead come from a bone pin or spoon (Fig 89). Part of a bone die was found in F199 (Fig 99). Both needles and dice are comparatively rare as grave goods. A pair, hollow like the one from F199, came from a grave dated to between AD 30-55 at King Harry Lane, St Aibans (Stead 8- Rigby 1989, 108, 178, fig 92, 20) and dice were also found with sets of gaming counters in graves at Chichester, West Sussex, and Alton, Hants (Down & Rule 1971, 117; Millett 1987, 68,). Another grave at Chichester, dating to the late 2nd or early 3rd century, contained one copper-alloy and eight bone needles, and iron needles were found in both pre- and post-conquest graves at King Harry Lane (Down & Rule 1971, 113-15; Stead & Rigby 1989, 107).

An unusual group of iron fittings came from F114 (Fig 90). They include a complete link and two fragmentary links from a chain, as well as two penannular loops with overlapping ends. The only tools to come from graves are both of stone and both may be residual. One is a fragment of a sandstone hone from F42 (Fig 89), the other is a fragment of a flint pebble, possibly utilised as a polishing tool, from F126.

A few cremation burials contained small amorphous fragments of iron or copper- alloy pyre debris and these are shown in Table 29, but flakes of iron recovered from environmental sampling have not been shown in the table if the burial already contained iron objects.

In terms of gender the funerary deposits, both primary and secondary, point to F36, F101/F107, F120, F128, F134, F162, F199, F200 and F209 (and possibly F41) as being burials of females, in some cases definitely juveniles (F162, F209), while the remaining deposits cannot be assigned with certainty to either sex, although perhaps the chain in F114 is more likely to be from a male grave than a female one. The inclusion of protective images in F42 and F53 suggests that these are the graves of children, and the same may be true of F19. The cremated bone report is at variance with some of these interpretations and puts F19 as definitely adult and F200 as an uncertain male.

The absence of brooches is unusual, but several factors have probably contributed towards this lack: the burial rite, the date range of the graves, and, to some extent, the population buried in the cemetery. The rite of cremation means that brooches worn by the dead may have been completely destroyed on the pyre, and fragments of copper-alloy debris from a few of the graves may be all that now remains of any dress accessories. There is a general decline in brooch use in south-east Britain from sometime in the last quarter of the 1st century, so that any burials at the Handford House site post-dating c AD 75/80 are much less likely to contain brooches than earlier ones. Although there are few grave goods at the Handford House site which can be positively dated to before that date, those that are present show that the population buried there primarily consists of incomers to the province rather than native British. The inclusion of a coin as a ferryman's fee is a Roman rite, as is the use of phallic and other apotropaic imagery, while the presence of picture lamps is an indicator of a wholly Romanised life-style (Eckardt 2002a, 43).

Any relationship between a Romanised population and the use of brooches as grave goods in the pre-Flavian and early Flavian periods is more difficult to establish, given the fluidity and mutability of contemporary populations and their material culture. Brooch deposition is certainly a major characteristic of Late Iron Age cemeteries, such as King Harry Lane, St Aibans (Stead & Rigby 1989, 87-103), but brooches are also found in some numbers in the pre-Flavian and early Flavian periods in the colonia at Colchester, as well as in the Balkerne Lane canabae and at Sheepen (CAR 2, 7-18; CAR 6, 140-43, 206-9; Hawkes & Hull 1947, 308-328; Bayley & Butcher 1985). However, many of the imported types among Colchester's early post-conquest brooch assemblage are those used by

Roman military personnel, who do not appear to be represented at the Handford House site, and many of the others are British-made and so are perhaps most likely to be British-worn. The late 1st-century decline in brooch use in south-east Britain mentioned above compared to the high numbers found in the west at the same period argues strongly that more Romanised populations made less use of brooches, and therefore an absence of early brooches at the Handford House site may be yet another indicator of a highly Romanised group of people.

Residual pyre debris

A small number of objects from some of the cremations and inhumations derive from earlier burials and are noted as residual in their respective grave catalogues but not listed here. Residual material in service-trench F18 derived from cremation burial F19 and has been catalogued under that burial.

Three small fragments of copper-alloy, probably pyre debris, came from the drain trench F20, and hobnails from F17 and F91 are also probably Roman. A possibly burnt coin of Septimius Severus from ditch F2 (listed in Table 28 and see coins above) may have been a pyre deposit, although if so it is probably the latest item among the small finds from the cremations.

- SF 9 (82) F20. Modern drain. Two small copper-alloy lumps, probably refrozen or heat-affected pyre debris. Weight 0.95 g.
SF 178 (97) F20. Modern drain. Small copper-alloy fragment, probably refrozen pyre debris. Weight 0.16 g.
(204) F17 Post-medieval or modern ditch. The head of an iron hobnail. SF 236. (357) F91. Probable 19th-century excavation trench. Iron hobnail, length 13 mm.

Inhumation burials

Apart from nails, some from coffins, some residual from earlier burials, the only item from the inhumation burials is a shale armlet, large enough to be more accurately termed an arm-ring and found on the left upper arm of the adult male burial F119 (Fig 94). Close typological dating of shale armlets is not possible and the absence of other dated finds from this grave means that there are two main periods when this burial may have taken place. Arm-rings are generally characteristic of La Tène male burials, making a Late Iron Age or very early Roman date possible, despite inhumation being very rarely practised at this period in south-east Britain, but alternatively it may be late Roman, as a shale armlet of similar size, although of different form, has been found in a late 3rd- or 4th-century male inhumation in London (Barber & Bowsher 2000, 221-2, B673.4, table 8, B673).

Other Roman objects

The following items are listed by material, and within material by feature or context.

- Fig 100, SF 104. (787) F152. Post-medieval or modern ditch. Fragment of a copper-alloy finger-ring similar to CAR 2, fig 50, 1778, with the hoop narrowing to a rebate abutting the bezel. Probably late Roman. Internal diameter at least 14 mm, maximum width 5 mm.
Fig 100, SF 48. (363) F96. Modern ditch. Copper-alloy terminal in the form of a stylised swan's head, broken at the top of the neck. Length 36 mm. The birds on such terminals are conventionally called swans, but rarely closely resemble any of the species found today in Europe. They may perhaps be more accurately identified as geese, but this particular example has a broad rounded end to the beak which is more duck-like. The term 'waterfowl' should perhaps be preferred.

This is the lower terminal from an early Roman cart fitting, the majority of which come from the military areas of Britain and northern Europe, and is particularly close in style to one from Water Newton, Cambridgeshire (Webster 1958, 74-5, fig 3, 37, fig 8, 232; Toynbee & Wilkins 1982; Crummy 2000). They take the form of an hexagonal socket surmounted by an eagle's head, with a goose or swan head rising upwards from the base of the socket. Sometimes there are two lower projections. These objects were first identified as cart fittings by Károlyi in 1890, and were further studied by von Mercklin (1933) and Alföldi (1935). They were nailed to the top of a wooden pole around which the reins were tied when the vehicle was stationary. The basal swan or goose head projection prevented the reins from slipping downwards. Wear/polish on the underside of the Handford House site example may have been formed by contact with leather.

The iconography of the Continental examples is not always zoomorphic and not restricted to birds. One has a panther's head top with basal horse's head, others have simple bell or baluster-shaped tops with the lower projection in the form of a finger, snake, or basilisk, or simply left plain. An unusual example in the British Museum, but not necessarily from Britain, shows two human heads.

Most of the British examples date to the 1st century and have the eagle and waterfowl combination, but there is a later one from Vindolanda, perhaps as late as the 3rd century, that is topped by a full-figure horse, and there is a related griffin-shaped fitting from Trawscoed, Dyfed (Toynbee & Wilkins 1982; Davies 1987). A military connection for the British examples is supported by their geographical distribution, association with military

establishments, and iconography. The eagle is both the symbol of Jupiter and of imperial might, while the goose is the symbol of Juno, and also the companion of the martial northern deity Mars Thincsus (Toynbee 1973, 262). If, however, the bird is really intended to represent a swan, then it may provide a link to the imperium through Augustus, who claimed the patronage of Apollo, represented on the Ara Pacis by swans (Crummy 2000).

Colchester has produced two eagle heads from these fittings (Webster 1958, nos 51 and 68), and a damaged socket lacking both the head and the terminal of the basal projection came, appropriately, from a Roman street surface (CAR 2, fig 109, 2545). The head of a waterfowl from Balkerne Lane is probably also from a cart fitting, but two other heads from the same site are more delicate and likely to come from vessels (CAR 2, fig 76, 2035-7).

- Fig 100, SF 98. (710), unstratified. A copper-alloy folded sheet rivet with slightly dished surface. Length 24 mm, width 12 mm, thickness 5.5 mm. These rivets were used to repair splits and holes in the walls of metal vessels, either singly or multiply as a means of attaching a patch, and they generally occur in medieval contexts (Egan 1998, 16). However, this example is listed with the Roman objects as very little medieval material has been found at the Handford House site, and a stratified Roman sheet rivet has recently been found at Silchester (University of Reading excavations, SF 2616).
- Fig 100, SF 243. (358) F91. Pit or 19th-century excavation trench. Pewter base sherd from a plate or dish with low V-section footing. Minimum diameter 130 mm. Probably a disturbed grave deposit.
- SF 60. (404). Unstratified. Lead wedge, used in wall construction to level individual stones or bricks (Cochet 2000, 53). Maximum dimensions 40 by 35 by 23.5 mm.
- SF 61. (405). Unstratified. Large lead plug, used to repair a ceramic vessel or a lead container. Maximum dimensions 62 by 54 by 14mm. Possibly post-Roman.
- SF 181. (210) F54. Roman pit. Fragment of iron sheet. Maximum dimensions 26 by 21 mm.
- Fig 100, SF 198. (417) F104. Pit. Early/mid 2nd to mid/late 3rd century. Large convex counter made from a sherd of a grey ware latticed jar; one side is missing. The edge is slightly irregular but ground smooth. Maximum surviving diameter 79 mm, thickness 9 mm.
- Fig 100, SF 43. (328) L1. Topsoil. Small counter made from a sherd of grey ware; a small piece is missing. The edge is worn smooth and both faces are abraded. Diameter 30 mm, thickness 7 mm.
- SF 51. (379) L1 (T49). Topsoil. Fragment of a small grey ware counter. The edge is roughly shaped but slightly worn; both faces are abraded. Diameter 37 mm, thickness 9 mm.
- SF 188. (852) L1 (T68). Topsoil. Fragment of a slightly convex grey ware counter. The edge is slightly irregular but ground smooth. The surfaces are abraded and the inner one is spalled. Diameter 45.5 mm, thickness 6 mm.
- SF 118. (1017) L1 (T79). Topsoil. Fragment of a small grey ware counter. The edge is smooth and both faces are slightly abraded. Diameter 36 mm, thickness 6.5 mm.
- SF 12. (127) F39. Post-medieval pit. Small subsquare counter made from a thin fragment of tile, with two pairs of parallel grooves crossing the upper surface. Dimensions 25 by 25.5 mm, maximum thickness 7.5 mm.
- SF 30. (187) L1 (T15). Topsoil. Semicircular tile counter, with the straight edge as much abraded as the rounded one. Diameter 71 mm, thickness 22 mm.
- SF 31. (188) L1 (T15). Topsoil. Broad tongue-shaped fragment of tile, possibly reworked from an antefix. The broad end is slightly pointed and is ground smooth. One corner is missing. Length 59 mm, width 57 mm, thickness 15.5 mm.
- SF 233. (414) F105. Pit fill. Post-medieval. Fragment of Mayen lava from a quernstone. The grinding surface is smooth. Maximum dimensions 56 by 61 mm, 31 mm thick.
- SF 111. (912) L1 (T77). Topsoil. Ten fragments and many tiny pieces of Mayen lava from a quernstone. Small patches of original surfaces remain on two of the fragments. Weight 574 g.
- SF 14. (144) L12. Roman layer. Five fragments of Mayen lava from a quernstone. No original surfaces survive. Weight 647 g.

Post-Roman objects

A summary catalogue of post-Roman and undated items, mainly small fragments, is included in the archive. The majority date to the 19th and 20th century, but there is an early post-medieval buckle fragment from L38. A lead musket ball may be associated with the Civil War.

7.4 Lamps

by Hella Eckardt

Lamps are relatively rare in the province of Britain, with Colchester and London providing by far the most examples (Eckardt 2002a). Especially in the 1st century, there appears to be a strong bias towards urban and military sites, with few examples coming from smaller towns and the countryside. The selection of lamps from the Handford House site fits into the picture very well, and the range of lamps underlines the importance of Colchester for Romano-British lamp studies.

Both picture lamps and factory lamps (Loeschcke 1919; Bailey 1980; Bailey 1988) are represented, in two cases in the same burial, F141 (Fig 97) and F199 (Fig 98). Both these picture lamps would thus have been quite old when deposited and the interpretation of their presence in these graves is uncertain (see section 7.3). The typological change reflects a chronological development, with picture lamps generally dated to the second half of the 1st century (in Colchester usually pre-Flavian), while factory lamps occur from the Flavian period onwards. In Britain, lamp numbers decline sharply in the early 2nd century.

It is difficult to establish the provenances of ceramic lamps without detailed fabric analysis, but it appears that both imports (from Gaul and probably also Italy) and local products are represented. Colchester is one of the few British sites for which lamp production can be demonstrated, and a workshop at West Stockwell Street is thought to have operated from AD 49-60/1 (Eckardt 2002b). None of the designs match the moulds or lamps from the West Stockwell Street site, but the fabric of the picture lamp from F199 indicates that it is a Colchester product.

Lamps deposited in Roman burials as grave goods may have been intended to guide the deceased into the afterlife. In Britain, the majority of lamps come from cremation burials and Colchester is one of the most prolific sites in this respect (Eckardt 2002a, 98-115). Most of these Colchester finds are, however, derived from antiquarian excavations largely lacking detailed context information (eg May 1930), which makes this collection even more valuable.

In several burials from the Handford House site, the lamps appear to have been placed into the grave lit. This is suggested both on the evidence of the lamps themselves (burning around the wick hole) and of the grave structure. It has been suggested (Philpott 1991, 191) that lamps in burials may have been placed and lit in order to reflect lighting arrangements in a house. Thus at Rougham, Essex, the spike and hook of an open lamp was actually driven into the wall of the burial chamber and at Avisford, East Sussex, ceramic open lamps were placed on ledges in all four corners of a burial cist (Eckardt 2002a, 109-110). From the 'blackened greasy earth' found beside an example from Guilden Morden, it has been suggested that it was deposited lit (Philpott 1991, 191). At the Handford House site, several lamps were placed in cavities formed by flagon sherds, perhaps in an attempt to symbolise lighting arrangements within a house or, more likely, to protect the flame from being extinguished when the grave was filled in and so enable the lamp to provide light on the journey to the underworld. A Romano-British amphora burial from Warwick Square in London contained two factory lamps that appear to have been adapted to provide a brighter light in their funerary context (Eckardt 2002a, 101, fig 45).

With picture lamps, it is possible that a particular design was chosen for its funerary symbolism, and Nina Crummy has suggested here that the lamps from both F42 and F53 are instances of such selection (Figs 88-89 and section 7.3), although it has proved difficult to demonstrate that this took place more generally in Romano-British burials (Eckardt 2002a, 117-33)

Lamps from non-burial contexts

- SF 149. (236) L1. Residual in topsoil. Wall fragment of a picture lamp. Whitish-buff fabric with large inclusions; slip completely worn off; probably a pre-Boudiccan local product.
- SF35. (225) L2. Residual in topsoil. Twelve very small fragments from the wall and base of a picture lamp. Buff to yellow-green fabric with worn slip, possibly local. Second half of the 1st century, probably pre-Boudiccan.

7.5 Roman glass

by H E M Cool

Roman glass vessels, or the remains of them, which seem directly related to funerary activities, were found in eight cremation contexts and one *bustum* (see Table 14). In addition, a small fragment of glass was found in the cremation burial F41 (finds no 129) and another in the disturbed cremation burial F45 (finds no 175). They show no obvious signs of melting, and are possibly chance inclusions in the fill. The colour of the glass suggests they are of a 1st- to 2nd-century date. In the following report, the glass will be discussed first according to whether it is clearly a pyre good, a grave good or from a non-funerary context. In the final section, the way in which the glass vessels were being used in the Handford House site cemetery, compared with other contemporary cemeteries at Colchester and elsewhere, will be considered.

Table 14: the distribution of glass vessels at the site.

(Note: the ? entries in the pyre goods indicate the presence of additional melted fragments which may come from the identified pyre goods or from other vessels.)

Feature	Pyre goods		Grave goods		
	Unguent	Unknown	Urn	Cup	Flask
F19	1	?	-	-	-
F42		?	-	1	1
F47	-	1	-	-	-
F53	-	1	-	-	3
F114	-	1	-	-	-
F126	-	1	1	-	-
F127	-	1	-	-	-
F142	2	?	-	-	1(?)
F181	-	?	-	-	-
Total	5	5	1	1	5

The pyre goods

Melted glass from vessels which had been placed on the pyre was present in three cremation burials (F42, F142, F181) and *bustum* F47. In one burial (F114), small fragments of glass were recovered from the cremated bone. Although these show no obvious signs of burning, it seems reasonable to conclude that they had been on the pyre and had been collected along with the bones for deposition. In addition, a fragment of possibly heat-affected glass was recovered from the disturbed cremation burial F19 (F19.10). In F42, the remains of two blue/green tubular unguent bottles were found (F42.11 and F42.15; Fig 102), as well as additional formless fragments of melted blue/green glass (F42.12 and F42.13) from them or other pyre goods. F19.10 also comes from this type of vessel. Tubular unguent bottles (Isings Form 8 in Isings 1957) are the dominant unguent bottle type of the mid 1st century AD both in Britain and elsewhere, going out of use in the Flavian period (CAR 8, 159; Price & Cottam 1998, 169). They were effectively packaging for the contents, which were almost certainly oil, possibly perfumed. As such they are not likely to have been curated, and the presence of them in these deposits suggests that the funeral took place not later than c AD 75-85.

F142.5 appears to come from a slightly different form of unguent bottle with a shorter neck, possibly a relatively tall conical reservoir, and small horizontally out-bent rim which appears sheared. It was possibly a small version of the conical flask no F53.12 which is discussed below in the grave goods section. A mid 1st-century date would again be appropriate. At least one other unguent bottle was placed in the pyre of the individual in F142, as there is an additional melted cylindrical neck (F142.5) from the grave.

Cremation burial F181 produced a melted blue/green lump (F181.3), the form of which cannot be identified. The fragment weighs 10g which would be equivalent to the weight of a small tubular unguent bottle. The complete unguent bottle (F42.16, Fig 102) from F42, for example, weighs 11g

including some soil infill. The blue/green colour is certainly appropriate for a container. The colourless melted fragment (F47.4) from the *bustum* F47 is unusual in two respects. The first is that it weighs less than 1g. Technically a *bustum* is where the pyre site becomes the place of interment. If a glass vessel had been on the pyre, more glass would be expected, unless the site was stripped of cremation pyre debris prior to the burial taking place, which would appear to be contrary to the aims of a *bustum*. There must, therefore, be the possibility that this was a chance vessel glass fragment that was fortuitously in the area in which the pyre was being built. The other unusual feature is that it is colourless. This was the type of glass used for tablewares, and all of the other glass pyre goods appear to be containers. This might, again, suggest that the fragment was a chance inclusion. The colour is, however, of use in helping to date the deposit, as colourless glass only started to be fashionable in the AD 60s, but was still rare by the late 1st century. It only became common in the 2nd century.

The grave goods

At the Handford House site, a glass vessel was used as the urn in one burial (F126.1; Fig 103). It is an example of a square jar with a collared rim (Isings Form 62). These appear to have been rare in Britain, but this may be because of the difficulties of identifying them from fragments (CAR 8, 185). They are made in two ways; some are free blown with the square profile produced by flattening the four sides, while others are blown into a square mould producing a moulded design on the base in the same way that square bottles were produced (CAR 8, 179; Price & Cottam 1998, 194). This example was clearly blown into a mould.

Dating the mould-blown jars is not simple, because of the lack of well-dated comparanda from settlement sites. Price and Cottam (1998, 135-6) list a number of square jars from Roman Britain, mainly from burial contexts, but most are of the free-blown form. A mould-blown example with similar rim formation and base design was found at Gloucester serving as a cremation urn; but, as it was an antiquarian find, it provides no useful dating evidence (Lysons 1792, 131, fig 1). Isings (Isings 1957, 81) notes that square jars are found in large numbers on sites destroyed by the eruption of Vesuvius in AD 79 and goes on to cite parallels up to the 4th century. The Campanian examples tend to be the free-blown flattened type (see for example Scatozza Hörich 1986, 68 Forma 55; Stefani 2003, 180 no H12). Dated examples which were definitely blown into a mould, with the collared rim seen on jar F126.1 and with a concentric circle pattern on the base, include one from a grave in Trier (Germany) which also contained a coin of Vespasian (Goethert-Polaschek 1977, 182 no 1137), and another from a grave at Locarno (Switzerland) dated to AD 70-120 (Simonett 1941, 163 no 8; Carazzetti & Biaggio Simona 1988, 74 no 68). Elsewhere, mould-blown collared jars have been found in late 2nd- to 3rd-century graves such as that at Stein in the Netherlands (Isings 1971, 39, no 126) and several from Poitiers in France (Simon-Hiernard 2000, 95-7, nos 22-5). These later ones frequently have patterns on the bases which do not only consist of concentric circles, and the rims often do not conform to the rolled in then rolled out collar seen on F126.1. The later ones often also have a pontil scar, a feature which is rarely seen on glass vessels prior to the mid 2nd century.

F126.1 would thus appear to belong to the earlier part of the production of these jars. A Flavian to early 2nd-century date would certainly be appropriate, given the evidence from the Colchester town-centre Roman sites. Both the collared rim and fragments from mould-blown square vessels only start to occur in the archaeological record in any quantity in post-Boudiccan contexts (CAR 8, figs 7.1 and 11.6).

Two glass vessels were deposited as grave goods in the cremation burial F42, both being found inside the urn. One was a tubular unguent bottle (F42.16; Fig 102) of the same type as those burnt on the individual's pyre (F42.15; F42.11). The other is an example of a Hofheim cup (F42.17; Fig 102). These cups (Isings Form 12) were a mid 1st-century form which was going out of use in the AD 70s (Price & Cottam 1998, 71). The distinct kick in the centre of the base of F42.17 might hint that it was in use during the later part of the life-span of the type (see Berger 1960, 43); certainly this base form did not occur in the town-centre Roman sites in Colchester in pre-Boudiccan contexts.

The other cremation burial where whole glass vessels were definitely being placed unburnt in the grave was F53, where three blue/green conical flasks (F53.10, F53.11, F53.12) were found within the urn (Figs 20-21 and 102-103). All have elements which suggest that they are of mid 1st-century date. F53.10 has a rim with a very small triangular profile. In the Colchester town-centre Roman sites, nearly half of the flask rim fragments with this profile were found in pre-Boudiccan contexts (CAR 8, 164). It is the rim form found on two flasks from one of the cremation burials at the Sheepen site, for which a Neronian date seems most likely (Charlesworth 1985, mf 1:A8, nos b and c). Both of the blue/green

flasks in the famous figurine grave at Colchester also have this rim formation, although with slightly more bulbous bodies (Eckardt 1999, 74, fig 7, nos 37/1139 and 38/1140 - NB in neither is the rim formation drawn accurately in these illustrations). A date in the decade before the Boudiccan revolt seems most appropriate for this grave as, although some of the grave goods could equally date to the years immediately after that event, the circumstances of the town would seem to preclude that. If we are to believe Tacitus (*Annals* xiv.29-39), there would have been no colonists left to bury their dead with such elaborate ceremony.

F53.11 is a tall conical unguent bottle differing from a tubular unguent bottle only in that it has a flattened rather than rounded base. It would have been in use at the same time as the tubular form. A very similar one, for example, came from a mid 1st-century cremation burial at Little Alie Street, London (RCHME 1928, 159, fig 65, no 28). The tall conical form seems less common than the tubular one, but that may just be because of the larger capacity. A very similar example to this has been found in Colchester before, presumably also from a grave, although it is now without provenance other than the fact that it formed part of the Joslin Collection (Colchester and Ipswich Museums, JOS 299).

The rim on F53.12 consists merely of a small horizontally out-turned edge. This was a very rare rim form amongst the material from the Colchester town-centre Roman sites, and the only example was found in a context which dated from the mid 1st century to the early 3rd century (*CAR* 8, 163 no 1261). In discussing that example, we suggested that it should be regarded as being a variant of the rim finish on tubular unguent bottles. The discovery of F53.12, in association with the two undoubted mid 1st-century flasks F53.10 and F53.11, shows that this is indeed the case.

In two cases (F53.11, F53.12), the vessels, although complete, are broken at the rim. Both fragments of F53.12 were found in the same excavated spit, but, in the case of no F53.11, the main part of the vessel was found in spit 4 and the rim in spit 7, suggesting that the vessel was placed into the urn after it was broken. Presumably the contents were used during the interment ceremonies, possibly poured over the burnt bones.

In addition to the unguent bottles placed on the pyre in cremation burial F142, there are seven fragments of another tubular unguent bottle (F142.4) placed with the cremated bones in the pyre and found within the urn (Figs 46 and 103). The fragments join, but parts of the rim and body are missing. Most were found in spit 6, but some came from spit 7. The rim and neck area show an altered surface, possibly from the action of heat. Clearly this was placed in the urn in an incomplete state. It may have been a pyre good but, given that the degree of heat alteration is very slight, it must have been in a peripheral position if placed on the pyre. It should probably be regarded in the same light as the flasks in F53, and the altered surface may have come about because of burial in contact with the hot bone.

Glass from non-funerary contexts

Four of the fragments found in non-funerary contexts relate to the funerals which took place on the site, as they are melted. One of the fragments is from a later pit (F34) but undoubtedly derives from the cremation burial which it cuts (F36); this fragment is listed as F36.5. The other three are clearly derived from pyre goods: F125 (606); F152 (788); and L1 (852). All are in colours which tubular unguent bottles are known to have been made in, and it seems very likely that they came from perfume containers placed on the pyre. There are also a number of unburnt blue/green fragments (L1 (236); F51 (191)) which may be dated to the 1st to 3rd centuries. One of these fragments (finds no 236) retains features which suggest that it is from a jug, but is otherwise undiagnostic. A fragment of cast window glass of 1st- to 3rd-century date was also found in pit F106 (420).

L1 (236), SF 158, T20. Jug; 8 body and base fragments. Cylindrical neck curving out smoothly to globular body; convex-curved body fragments, one preserving the rounded end of a handle attachment; one lower body curving into concave base. Diameter of neck approx 22 mm, wall thickness 1 mm.

F51 (191), T14. Blue/green body fragment.

F34 (91), T13. Melted yellow/green fragment. Weight 8g.

F125 (606), T54. Melted blue/green fragment. Weight 6g.

F152 (788), SF 105, T56. Melted blue/green lump. Weight less than 1g.

L1 (852), SF 189, T68. Melted deep blue lump. Weight 3g.

F106 (420), T47. Window glass: 1 fragment of light green cast matt/glossy. 5.5 cm 2.

An overview of vessel use in the cemetery

The types of glass vessels identified in the cemetery suggest that burial was taking place here in the mid 1st century. There is very little evidence, other than the collared jar which was used as an urn in F126, that glass vessels continued to be part of the funeral ritual by the late 1st century.

On the whole, the type of vessels being used, ie flasks and unguent bottles, are typical of what is found in Roman centres in mid 1st-century Britain. Precisely the same type of tubular unguent bottles, for example, both burnt and unburnt, as here, were found in a cemetery associated with the legionary fortress at Lincoln (Jones 2002, 48 colour plate 7) and in cemeteries around Winchester (Collis 1978, 85, fig 30.20 and 102, fig 40.49; Victoria Road excavations, unpublished). They are also very common in the cemeteries around Colchester, where it is clear that they were regularly put on the pyre as well being placed in the grave unburnt. Mid 1st-century burials which have both flasks as grave goods and melted glass indicative of vessels placed on the pyre include the 'child's grave' with figurines (Eckardt 1999, 74), and, following the numbering of May 1930, graves 7/24, 29/47 and 44/26. Grave 7/24 is especially interesting as the records state that the whole unguent bottle was placed in the urn, presumably following precisely the same rite as that seen at the Handford House site. May regularly recorded unguent bottles and flasks from the burial groups, and many more complete examples from Colchester survive in the Colchester and Ipswich Museums, although now without provenance. The contents of these vessels must have been regularly used during the funerals.

The use of a glass vessel as a cremation urn appears to be much less common. May notes only three instances (May 1930, Joslin graves 65/78 and 83/79; Taylor grave 9/8), all of which certainly post-date the mid 1st century. This fits a pattern that Philpott (1991, 26) has observed more widely in Roman Britain, and probably suggests that the glass urn from F126 is later in the sequence than F42, F53 and F142. As we have seen, the glass urn from F126 would fit, typologically, more happily into a later 1st- to earlier 2nd-century milieu than earlier.

The deposition of glass drinking cups in mid 1st-century graves is very uncommon, which is interesting because they are a very common site find. In the town-centre Roman sites excavated at Colchester, for example, a minimum of 35 Hofheim cups were recovered (*CAR* 8, 64). F42.17 is the only certain example ever to have been recovered from a grave in Britain; although there are two other candidates, both now without provenance but both with Colchester connections, that might have been. One, now in the British Museum (accession no 1870.4-2.3), formed part of the collection of the Rev J H Pollexfen who is known to have collected much material from burials in Colchester in the mid 19th century. It is a pale yellowish green, and of similar shape and base pattern to F42.17. It is complete but mended, and the likelihood that it came from a grave at Colchester must be very high. The second is another complete Hofheim cup from Colchester in the stores of the Colchester and Ipswich Museums. It is pale blue/green and more cylindrical than those which are regularly found at Colchester. From its state, it presumably originated from a grave. Whether that grave was at Colchester, however, is open to question. The form and colour are unusual, judged against a background of undoubted Colchester finds, and it may be a vessel brought back to this country from abroad in modern times. It is known that some vessels in the collections originated in this way.

Another glass cup of this date which also formed part of Rev Pollexfen's collection, the famous Colchester circus cup, was found with a cremation burial in the West Cemetery in Lexden (Harden *et al* 1987, 168 no 89). Again this is a type which was clearly popular in daily use. Excluding the one from the West Cemetery, there are a minimum of 12 known from the Colchester/Sheepen area (*CAR* 8, 44), but this is the only example to have been found in a grave in the UK.

The way in which glass drinking vessels are normally almost always excluded from grave contexts suggests that the individual buried in F42 was of some special status.

In general, therefore, with the possible exception of F42, the use of vessel glass in funerary ritual at the Handford House site follows the normal pattern seen in the cemeteries surrounding Colchester in the mid 1st century. It confirms the normal practice of using the contents of the vessels on the pyres, as well as in the post-burning rituals, and the emphasis on containers rather than tablewares. This pattern is very different from that seen in the contemporary and earlier graves at the sites of Stanway Quarry (Crummy *et al* 2007) and Sheepen (Niblett 1985, 22), and the vessels do seem to reflect a difference in the burial rites of the native population and the colonists.

Acknowledgements

I am most grateful to Professor Jennifer Price for providing me with information about the Hofheim cup from the Pollexfen collection in the British Museum.

7.6 Cremated human bone

by Sue Anderson

Introduction

This report examines the cremated bone from 50 cremation burials, two *busta*, five other features and fourteen contexts within layers. A full catalogue of the cremated human bone can be found in Appendix 3 with Table 30.

Methodology

Collection methods varied depending on the size and type of deposit. Twenty-nine groups of cremated bone from pottery vessels were collected in spits. Upper fills of the *busta* were sampled and sieved, but bone fragments within the burials were collected and numbered individually. The remainder were collected as single groups of bone. With the exception of a few fragments which were hand-collected on site, all groups of bone (including separate spits) were wet-sieved and sorted into fractions <5mm and >5mm prior to analysis. The smaller fractions were mixed with pea-grit; fragments from the <5mm fractions of eleven sample residues were separated by hand before analysis so that the bone could be weighed. However, this task was very time consuming and in the remainder the amount of bone was simply estimated based on the approximate percentage of bone present, and scanned for recognisable fragments. Animal bone and artefacts were extracted for study by the appropriate specialist.

Bone fragments were sorted into five categories: skull, axial, upper limb, lower limb, and unidentified. All fragments were weighed to the nearest 0.1g. Measurements of maximum skull and long bone fragment sizes were also recorded. These data are listed in Appendix 3.

Observations were made, where possible, concerning bone colour, age, sex, dental remains, non-metric traits and pathology. Identifiable fragments were noted. Age of juveniles was estimated from tooth eruption and/or epiphyseal fusion where possible, age of adults from degenerative changes. Sexing of adults was based on size and robusticity. Methods used follow the Workshop of European Anthropologists (WEA 1980) and McKinley (1994 and 2004). A catalogue of burials is included as Appendix 3.

Quantification, identification, collection and survival

Table 15 shows the bone weights, percentages of identified bone from each burial, and the proportions of bone identified from the four areas of the skeleton (skull, axial, upper limb, lower limb). Expected proportions are provided in the first row.

Quantities of bone varied considerably, ranging from as little as 0.4g (F108) to 1,818.4g (F134). The total weights of bone indicate that the majority of these burials were substantially incomplete. The average bone weight per context for the whole assemblage (total weight 25,300.4g) was 361.4g. Mays (1998, table 11.2) notes that the combusted weight of an adult skeleton has a mean of around 1,500g for females and 2,300g for males. Only one of the burials in this group (F134) was within this range, and only seven produced more than 1,000g of bone.

Graph 2 shows the percentages of bone identified for each burial against the total weight of bone. There is no particular correlation between the two, although smaller quantities are more likely to fall at either end of the graph, being either wholly unidentifiable or fully identifiable. The two *busta*, F47 and F134, fall towards the higher end of the graph, both with over two-thirds of the remains identifiable.

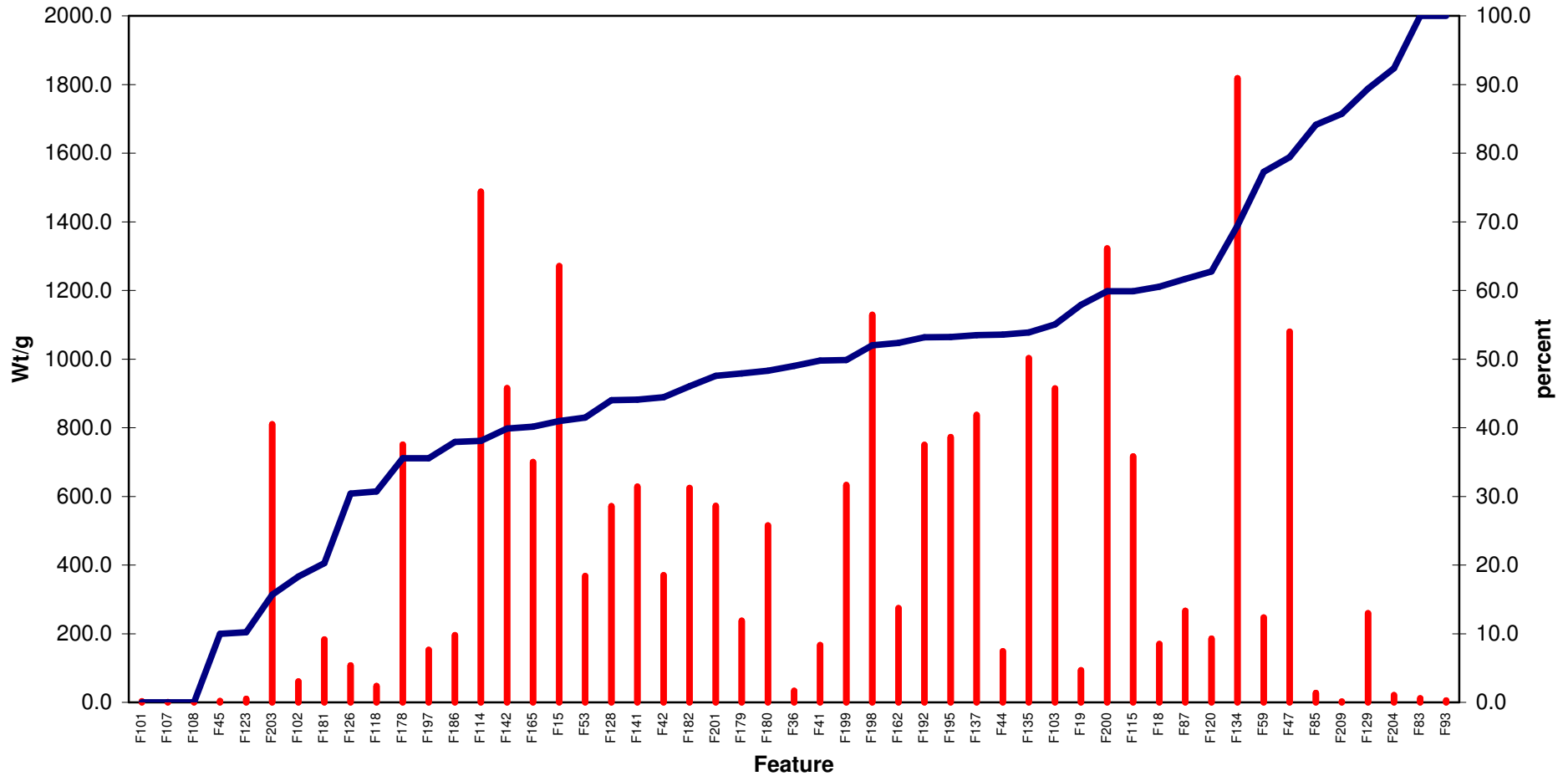
Table 15 shows that skull fragments are almost always over-represented amongst the identifiable material; only twelve burials with identifiable remains have less than the expected proportion of 18.2%. Conversely, only twelve burials had greater than expected proportions of identifiable axial fragments, and only eight had more than expected of the upper limb. Fragments of femur also appear to be more easily identified, and the lower limb is over-represented in 21 burials.

It has been suggested that 'it should be possible to recognise any bias in the collection of certain areas of the body after cremation' (McKinley 1994, 6). However, there is also some bias inherent in the identification of elements. McKinley notes the ease with which even tiny fragments of skull can be recognised, and, conversely, the difficulty of identifying long-bone fragments. These figures can therefore provide only a rough guide to what was originally collected. However, if the cranial vault is under-represented, this suggests a number of possibilities: ie that it was not collected, that it was deposited separately, that it was retained (as suggested by Wells 1981), or that it was in the top of a

truncated vessel. In this assemblage, F59, F115 and F179 seem to have lost a large proportion of their skull fragments - F59 and F179 were disturbed, but none of the three was truncated.

Table 15: Percentages of identified fragments out of total identified to area of skeleton.
(*expected proportions from McKinley 1994, 6)

Type	Feature	Total wt/g	% identified	% Skull	% Axial	% U limb	% L limb
	<i>Expected*</i>			18.2	20.6	23.1	38.1
Casket	F120	185.5	62.7	18.9	14.7	15.1	51.3
Urned	F15	1270.7	41.0	21.8	16.3	18.7	43.2
	F36	33.9	49.0	50.0	19.9	16.9	13.3
	F41	166.8	49.8	51.6	16.1	16.1	16.1
	F42	370.7	44.4	70.5	3.2	13.8	12.5
	F44	149.2	53.6	64.6	2.6	14.1	18.6
	F45	4.0	10.0	100.0	0.0	0.0	0.0
	F53	368.0	45.1	65.3	1.4	18.6	14.7
	F59	247.4	77.3	8.3	9.9	21.4	60.4
	F87	266.5	61.7	38.4	19.4	13.4	28.7
	F93	5.4	100.0	0.0	0.0	0.0	100.0
	F101/F107	4.0	0.0	-	-	-	-
	F102	61.1	18.3	84.8	2.7	0.0	12.5
	F103	914.8	55.1	17.2	32.6	15.3	35.0
	F108	0.4	0.0	-	-	-	-
	F114	1488.1	38.1	29.0	20.7	12.1	38.2
	F115	716.7	59.9	7.3	30.2	18.4	44.1
	F118	47.9	30.7	32.7	3.4	18.4	45.6
	F126	107.6	30.4	69.7	11.6	3.7	15.0
	F128	571.6	44.0	18.8	9.9	19.3	52.0
	F129	259.5	89.4	29.0	5.2	17.8	48.1
	F135	1002.7	53.9	27.6	21.9	12.5	38.0
	F137	837.2	53.5	30.2	29.0	21.0	19.8
	F141	628.3	44.1	25.5	12.7	15.1	46.7
	F142	915.4	39.9	19.9	25.7	19.7	34.8
	F162	274.8	52.4	53.2	23.2	8.4	15.1
	F165	700.1	40.2	27.7	19.0	8.1	45.3
	F178	751.0	35.5	19.1	5.7	15.5	59.7
	F179	237.9	47.9	6.5	6.3	10.5	76.7
	F180	515.5	48.3	11.4	4.9	16.5	67.2
	F181	183.5	20.3	74.5	6.5	9.9	9.1
	F186	195.4	37.9	39.4	4.6	13.8	42.2
	F192	750.2	53.2	30.8	10.4	13.9	44.9
	F195	772.5	53.2	35.5	4.0	23.3	37.3
	F198	1129.0	52.0	20.0	9.3	14.4	56.4
	F199	633.5	49.9	23.3	22.9	27.6	26.2
	F200	1322.7	59.9	25.8	17.4	26.0	30.8
	F201	572.7	47.6	51.3	4.4	18.7	25.5
	F204	20.9	92.3	0.0	0.0	64.2	35.8
	F209	2.1	85.7	61.1	22.2	0.0	16.7
Unurned	F18	170.0	60.5	35.8	11.0	28.2	25.1
	F19	93.8	57.9	46.8	13.8	19.0	20.4
	F83	11.6	100.0	37.1	8.6	15.5	38.8
	F85	27.1	84.1	44.3	9.6	40.4	5.7
	F123	9.8	10.2	100.0	0.0	0.0	0.0
	F133	23.3	100.0	0.0	0.0	0.0	100.0
	F182	624.7	46.0	26.5	8.2	21.4	43.9
	F197	153.2	35.6	18.9	14.5	32.8	33.8
	F203	810.1	15.7	11.4	7.3	8.0	73.2
Bustum	F47	1079.8	79.4	17.6	24.1	20.5	37.8
	F134	1818.4	69.4	16.0	36.9	10.2	36.9



Graph 2: Percent bone identified (blue) and total weight (red)

The cremation burials

Urned burials and boxed cremation burial

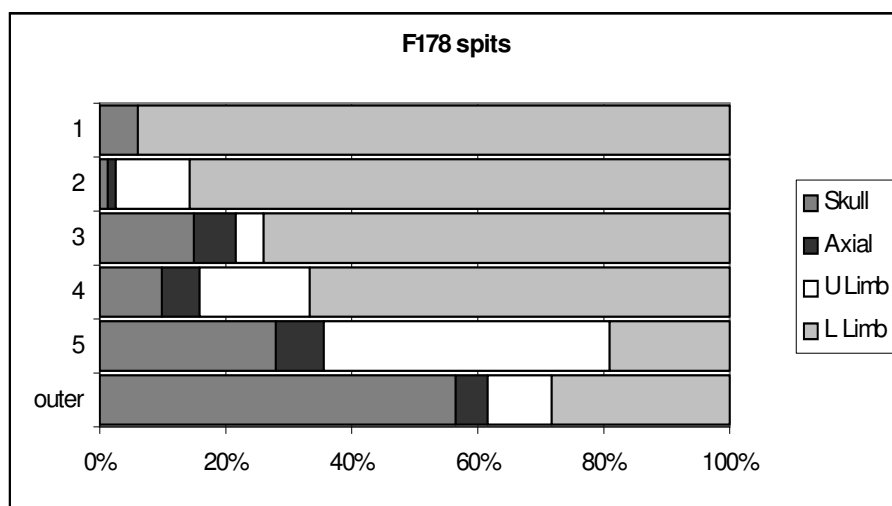
Thirty-nine urned cremation burials (including one in a glass vessel inside a box and one inside an amphora) and one boxed cremation burial were excavated. These are summarised in Table 16.

In general, the bones were well preserved and in good condition, with an average maximum fragment size of 57.6 mm (range 10-135 mm). Fifteen urned burials were disturbed, three of them truncated, and these had an average maximum fragment size of 48.5 mm, compared with 62.8 mm for the undisturbed burials. A few fragments, most notably in F181, F192 and F195, showed signs of abrasion. In the double cremation burials (F192 and F195), this affected only one of the two individuals.

The range of weights for these burials was 4.0g to 1,488.1g, with an average of 487.89. This is higher than the average weight of bone in urned burials at the Abbey Field (327.3g (including boxed cremation burials and cist); revised CAT Report 138 in prep), but lower than the average weights found at Baldock (619.29) and St Stephen's cemetery in St Albans (899.69; McKinley 2000b, 270). The disturbed burials had an average weight of 273.89, compared with an average of 600g for the undisturbed burials. Undisturbed urned burials at the eastern cemetery of Roman London had an average weight of 845g (McKinley 2000b, 270).

Six of these burials contained the remains of more than one individual, but only four (F42, F162, F192, F195; 10.5% of the urned burials) can be claimed as double cremation burials. F41 and F128 contained only small quantities of the second individual, a child in both cases. These were too few to indicate a separate individual and they may well have been collected and included in error if the pyre site had been used previously. Alternatively, they may have been included deliberately to accompany the main individual. The minimum number of individuals (MNI) for this group is 43.

Most of these burials were excavated in spits and this allows for the relative proportions of the four main skeletal areas to be compared. Graphs 3-4 show the results of this (based on percentages of identified fragments by weight) for F178, which showed the most structured pattern of collection on the site, and F200, which had the largest quantities of identifiable bone. In F178, there is an increase in the amount of skull towards the bottom of and outside the vessel; although the patterning is not particularly clear, there is a slight suggestion that the burnt bone was collected from the head end of the pyre first, working down to the feet. In F200, there is a fairly even spread of identifiable fragments. F186, F198 and F201 also showed this pattern. However, the majority of urned burials showed



Graph 3: proportions of skeletal area by spit from urned cremation burial F178.

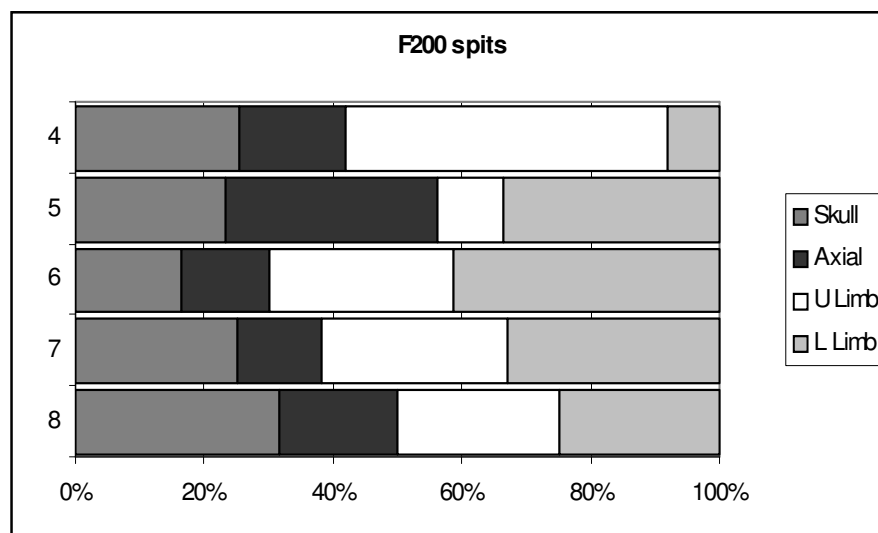
no real structure in the patterns of deposition of identifiable fragments (details in archive). This may be due to post-depositional disturbance, which seems to have affected many of the burials.

Another possibility is that more than one person was involved in collecting the bone, which would make it difficult or unnecessary to work systematically from one end to the other.

Table 16: summary of urned cremation burials.

Burial	Age	Sex	Notes
F15	MA/Old	M?	Well preserved with large fragments; some degenerative changes; appear large.
F36	adult	F?	Very incomplete, mostly small fragments; bones appear small epiphyses fused.
F41	i) adult ii) 8-12	U U	Very incomplete, but some large fragments; mainly adult fragments, few unfused epiphyses and ilium of child.
F42	i) c.5-6 ii) c.12+	U U	Incomplete, some large fragments; ages based on epiphyseal fusion tooth eruption. Too much skull for one individual, but not clear how many each may be represented.
F44	approx 2-3	U	Well preserved but incomplete; unfused femoral epiphysis.
F45	unknown	U	Poor, very incomplete.
F53	approx 3-5?	U	May be fairly complete, some large fragments; age based on eruption.
F59	adult	M	Very incomplete, some very large fragments; large robust tibia epiphyses fused, no degeneration; slight periosteal reaction on tibia fragment.
F87	adult	U	Very incomplete, a few large pieces; epiphyses fused, no degenerative wormian bones present.
F93	adult	U	Very small amount; identified as adult based on size.
F101/107	adult?	U	Very small quantity; some not certainly burnt and may be animal.
F102	approx 2-3	U	Very incomplete, some large pieces; unerupted molar crown fragments
F103	MA	F?	Well preserved, some very large fragments; small bones and femoral head, medial clavicle fused, some degeneration of vertebrae.
F108	unknown	U	Very little surviving, may not be burnt and could be animal.
F114	MA/Old	M	Possibly fairly complete, well preserved, particularly large femoral torso; large occipital crest and robust bones, degenerative disease partially obliterated cranial sutures; osteoarthritis of the right hip; osteophytosis of the spine, small exostosis of femoral shaft.
F115	Y/MA	F	Well preserved, large fragments, but incomplete; beginning of degenerative changes, wide sciatic notch and gracile bones.
F118	adult	U	Very incomplete but some large pieces; epiphyses fused.
F120	MA	F	Well preserved, very incomplete, but some large pieces; degenerative changes of vertebrae, gracile bones.
F126	approx 9-12	U	Incomplete, some large fragments; age based on tooth eruption.
F128	i) older adult ii) infant	U U	Incomplete, some large pieces; mainly adult with degenerative disease; small occipital crest but large axis odontoid process, only two fragments infant identified; osteoarthritis and osteophytosis of spine.
F129	MA/Old	F?	Very incomplete, but several large fragments; occipital crest prominent not large, some cranial sutures closed, degenerative disease; osteophytosis of spine, lipping of linea aspera of femur.
F135	MA/Old	M	Fairly complete, large fragments; degenerative disease, large occipital crest, robust bones and large vertebrae; large osteophytes of spine at other joints, possible diffuse idiopathic skeletal hyperostosis, osteoarthritis of medial clavicle.
F137	approx 16-1	F?	Incomplete, large fragments; unfused adult-sized epiphyses, small femur gracile.
F141	MA+	F?	Very incomplete, several large fragments; some degeneration, some seem small; osteophytosis of spine.
F142	approx 16-1	M	Incomplete, but some very large pieces, including near-complete vertebrae; age from epiphyseal fusion, sex from prominent occipital crest and large fingers.
F162	i) c.3 ii) older adult	U U	Very incomplete, some large pieces; age of child based on tooth eruption; older adult had degenerative disease. Most fragments from 883 and 884 (fill) were adult, fragments from 864 (urn fill) were mixed.
F165	MA+	U	Incomplete, some large fragments; some degeneration, large occipital crest, but cervical vertebrae appear small; osteoarthritis of the elbow; slight lipping at hip joint.
F178	approx 16	M?	Incomplete, some large fragments; unfused distal ulna, prominent occipital crest.
F179	MA+	U	Very incomplete, a few large pieces; some degeneration; lipping of linea aspera.
F180	adult	M?	Very incomplete, some large fragments; epiphyses fused, large occipital crest.

Burial	Age	Sex	Notes
F181	older adult	U	crest. Very incomplete, poor and abraded; degenerative disease; pc osteoporotic, osteophytosis of spine.
F186	approx 12+	U	Incomplete, some large pieces; age estimated from tooth eruptio epiphyseal fusion.
F192	i) adult ii) adult	F U	Fairly incomplete, well preserved, some skull fragments abra dec individual had a gracile occipital crest, at least one of the two indiv had degenerative changes; osteophytosis of spine and right shoulder
F195	i) adult ii) older adul	U M	Fairly incomplete, well preserved, some skull fragments abra dec individual was large and robust and showed degenerative changes.
F198	MA/Old	M?	Fairly complete with some very large pieces; teeth lost ante-m degenerative changes, robust bones, occipital crest fairly prorr osteophytes of spine, periostitis of tibia.
F199	adult	F	Incomplete, some very large fragments; epiphyses fused, bones sma gracile.
F200	young?	M?	Fairly complete, some large pieces; no degeneration, large robust k osteochondritis of right elbow (distal humerus).
F201	adult	F?	Incomplete, large fragments; epiphyses fused, small bones.
F204	adult	U	Very incomplete, some large fragments; size indicates adult.
F209	infant	U	Very incomplete, small fragments; age indicated by size of bones and thickness.



Graph 4: proportions of skeletal area by spit from urn burial F200.

The majority of bone in this group was fully oxidised and cream to white in colour, although occasionally fragments were grey, blue-grey or black, indicating incomplete oxidation. This was often seen on the inner surface of the skull, cancellous fragments of torso, and inner parts of the long bones, particularly the femur and tibia. The presence of a high proportion of white bone indicates firing temperatures in excess of approximately 600°C (McKinley 2004, 11). However, in comparison with two Early Bronze Age groups from Essex (Birch Pit, Colchester and St Osyth) recently analysed by the present author, it was noticeable that the Roman group contained a much higher proportion of grey-black bone. It appears that there was sometimes inefficiency in the cremation process, which has been noted at other Roman sites (eg McKinley 2000, 269; Wells 1981, 291). This might be more likely to occur if cremations were being carried out by specialist businesses, perhaps taking less care than might be accorded by relatives of the dead.

A connection has been suggested between F42, F44, F53 and F142 based on the use of gorse as a fuel and the close proximity of the burials within the cemetery (see section 7.9). F42 and F53 contained two halves of the same coin. All four individuals were under the age of 18, but otherwise there is nothing in the bones to suggest any association. F42 and F53 were of a similar age, but they were two individuals as there was duplication of part of the frontal bone.

Unurned or pyre debris deposits

Nine cremation deposits were unurned, although some of them may originally have been buried in perishable containers. Table 17 summarises the information collected during the study of these burials. The average bone weight for these deposits was 211.7g, and the average maximum fragment size was 40.2mm (range 9-60mm). Most of this material was well preserved, and large fragments were often present. Only F123 showed signs of abrasion.

Table 17: summary of unurned cremation deposits.

Burial	Age	Sex	Notes
F18	adult	M?	Very incomplete, several large fragments; bones medium-large, no obvious degenerative changes; metopic suture patent. Probably the same as F19
F19	mature	M	Very incomplete, some large pieces; some degenerative changes, large mastoid process; osteophytosis of the spine. Probably the same as F18.
F83	adult	U	Very incomplete, several large fragments; bone size indicates adult
F85	mature	U	Very incomplete, some large pieces; slight degeneration
F123	infant?	U	Very incomplete, chalky and abraded; skull thickness and bone size suggest infant.
F133	adult	U	Very incomplete, large pieces; size indicates adult.
F182	old?	M	Incomplete, several large pieces; degenerative changes and tooth loss, large occipital crest and fingers; osteophytosis of spine and hip joint.
F197	adult	F	Very incomplete, some large fragments; epiphyses fused, small bones.
F203	MA+	U	Incomplete, small fragments; degenerative changes to spine.

The MNI for this group is eight, although in some cases these were represented by such a small quantity of bone – as Table 15 shows, most were less than 200g in total weight – it seems likely that they were redeposited, either from more complete burials or within pyre debris. However, none is located close to a more complete burial. The small quantities for unurned material are not necessarily a result of the lack of a pottery vessel, as many of the urned burials in this group were also severely underweight. F182 and F203 contained enough bone to be considered intentional burials.

Colouration for the unurned cremated bone was fairly uniform and generally indicated full oxidation and high firing temperatures, although F18/19 and F203 produced several fragments of grey and black bone.

The Busta

Two features were identified as *bustum* burials, and these are summarised in Table 18. The maximum fragment sizes for these burials were 77mm for F47 and 160mm for F134. All bone was well preserved with no signs of abrasion.

Table 18: cremated bone from *bustum* burials.

Burial	Age	Sex	Notes
F47	MA	M	Incomplete but well preserved with many large pieces; robust bones, some degeneration; slight osteophytosis of spine.
F134	MA?	F	Probably complete, many large fragments; age determined from fragment of pubis and presence of degeneration, sex from wide sub-pubic angle, small and gracile bones; large Schmorl's nodes in lumbar vertebrae, osteophytosis of spine.

The total weight of bone collected from F47 was only 1,368g, which is well below the average for a male cremation. On the other hand, F134 produced 1818.4g, the only burial in this assemblage to contain enough bone to be considered 'complete'.

In a true *bustum* burial, it would be reasonable to suggest that all surviving cremated bone should be present. However, other excavated examples have produced relatively small quantities (Barber & Bowsher 2000, 62). Also expected is that the bone will be laid out in roughly anatomical order within the pyre pit or grave. This is true of F47 at this site, but not of F134. Neither contained large quantities of charcoal, which would be predicted if the pyre had collapsed *in situ*.

Whilst it seems unlikely that the individual buried in F134 was burnt *in situ*, F47 is more difficult to explain. Although a few fragments of the leg bones were scattered in the chest area of the grave, in general areas of the skeleton were deposited as would be expected, allowing for some movement as the pyre collapsed. So where were the remains of the fuel? One explanation could be that the feature was truncated and thick deposits of charcoal above the bone had been removed, but this would suggest that the body had been placed *under* the pyre, not the normal position and not the best place to ensure full cremation. However, the possibility that the bones in F47 could have been laid out in the correct order following redeposition is so small that it must be rejected.

A fairly high proportion of the bone from F47 was black or grey, suggesting inefficient cremation of these pieces. Perhaps the bone collected from this feature represents material which fell through the pyre before it had been fully cremated and before the pyre collapsed. If this were the case, bone may have been removed from the upper levels for burial elsewhere, and the pyre debris disposed of elsewhere, leaving half the skeleton *in situ* amongst the ashes in the flue. Even this suggestion seems a less than convincing explanation.

F134 contained so much bone, compared with the other burials from the site, that it could represent more than one individual. No duplication of bones was seen during recording, but there was some ambiguity in surviving sexing criteria. The sub-pubic angle was wide and the bones were generally small and gracile, but the occipital crest appeared fairly prominent. However, the overall impression was of a single individual. This burial contained at least 93.7g of animal bone, whilst none was identified in F47. Most of the bone from F134 was cream-white, although occasional black fragments were present (many of them animal bone).

Despite the size of the burial pit and the apparent dispersal of large fragments of bone within it, it seems reasonable to suggest that F134 was not a true *bustum*, and that the remains within it were redeposited. This is likely to have occurred soon after cremation and may indicate that the pyre was not far away — apparently there was no need for a vessel to transport the fragments, and less than the normal breakage had occurred.

Other features

Seventeen other contexts produced small quantities of burnt and calcined bone, much of it chalky and abraded. Table 19 summarises the information collected for these groups.

Table 19: cremated bone from non-burial features.

Context	Find no	Wt/g	Age	Sex	Notes
F8	96	5.0	adult	U	rib and acetabulum fragments only; age based on size.
F28	77	0.6	unknown	U	poor condition; may not be human.
F32	98	1.5	unknown	U	small fragments, no sexing or ageing criteria, but human.
F34	87	17.1	adult	U	some large fragments; clavicle is small and gracile but tibia is large, possibly more than one individual
F98	390	5.0	adult	U	some large pieces; size suggests adult.
L1	222	32.7	adult	U	some large pieces; size suggests adult.
	262, 264	193.3	adult	M	some large fragments; epiphyses fused, large ischium. Probably a disturbed and redeposited burial.
	314	8.0	adult	U	some large pieces; size suggests adult.
	350	98.0	adult	U	size suggests adult; small exostosis distal radius, osteophytosis of spine. May be from F87 or F83.
	1007	26.8	adult	U	size suggests adult
L2	6	4.0	adult	U	size suggests adult. May be from F181.
	63	5.9	adult	U	size suggests adult.
L16	354	8.1	adult	U	size suggests adult. May be from F87 or F83.
L23	377	8.0	adult	U	size suggests adult. Possibly from F197
L36	1188	1.5	unknown	U	poor, small fragments.
L38	1011	4.1	adult	U	size suggests adult.
L39/40	928	0.6	child?	U	size suggests child? Close to F180, which is adult.

In most cases it is likely that the material is redeposited, and may belong to other individuals excavated from the more complete burials. However, there is enough bone from L1 262 and 264 to count this a separate individual.

Demography

The total MNI for the cremation burials is 55, including unurned and redeposited material; if this is discounted, the MNI is reduced to 44.

Table 20 presents a summary of the distribution by age and sex. This shows a fairly even distribution through the age groups, although there is a peak of child deaths in the 'small child' category, perhaps as a result of childhood illnesses such as measles.

Of the 55 individuals, 13 (23.6%) were under the age of 18 years at death. This is a relatively high proportion in comparison with several other Roman cremation groups, which varied between 7.7% at Skeleton Green to 12% at Baldock, although at the cemetery of St Stephen's in St Albans, the figure was 21% (quoted by McKinley 2000, 265). At the large Iron Age cremation cemetery of King Harry Lane, St Albans, 12.8% of the aged individuals were non-adults (calculated from Stirland 1989, table 48).

Table 20: distribution by age and sex of urned cremation burials.

Age group	Unsexed	Male	?Male	Female	?Female	Total
Infant (0-2)	3					3
Small child (3-9)	5					5
Juvenile (10-15)	2					2
Sub-adult (16-18)		1	1		1	3
Young adult			1	1		2
Adult	10	2	1	3	2	18
Mature adult	4	2		2	2	10
Older adult	3	4	2		1	10
Unknown	2					
Total	29	9	5	6	6	55

Only one of the infants in the Handford House site group could be closely aged, and was thought to be approximately 9-12 months at death. This single individual under a year old represents 7.7% of the juvenile group, a relatively low proportion for a 'normal' population but not especially abnormal in a cremation group, as discussed by McKinley (2000, 266).

Three sub-adults, aged between 16 and 18 years, were present and all three showed sexing criteria, suggesting that one was female and two were male or possibly male.

The majority of adults for whom age could be suggested fell into the mature and older adult categories, but this is simply because older individuals are more easily identified amongst cremated remains, due to the presence of degenerative changes. The absence of this indicator would result in an individual being categorised simply as 'adult', and it is likely that a high proportion of this large group were young or mature. In comparison, a very high proportion of the individuals from Abbey Field were identified as sub-adult or young adult (Wade 2001), which is very unusual and may indicate some form of segregation.

Of the 42 adults, 23 (54.8%) could be sexed. There were twelve males or possible males and eleven females or possible females, giving a sex ratio of approximately 1:1, as expected in a normal population. At other Roman cremation cemeteries, more women than men have been identified, and McKinley suggests that there may be a bias towards the identification of women in cremated remains (McKinley 2000, 266), although this may be subjective as the present author finds the opposite to be the case. At the King Harry Lane site, 102 individuals were thought to be male or ?male, but only 33 were female or ?female (Stirland 1989, table 49).

Five women (41.7%) and eight men (66.7%) were mature or older. This slight difference between the sexes has been noted at other sites, for example the Eastern Cemetery of Roman London (McKinley 2000), but is not statistically significant.

Anatomical variants and pathology

Study of anatomical variants, dental disease and skeletal pathology is, unsurprisingly, difficult in fragmented human remains such as those derived from cremation. No prevalences can be calculated, so the following is simply a summary of observations of the few diseases and morphological traits which could be identified.

Very few anatomical variants were identified in this group. A metopic suture was present in F18. This suture, which divides the frontal bone of the skull, is normally obliterated by the age of six years, but in some individuals it remains patent into adulthood. Wormian bones, extra-sutural bones of the skull, were found in F87. A septal aperture was found in the distal left humerus of F115, and F165 had one in the right side. This trait can be related to gracility and is often more common in women than in men. Only one of these individuals could be sexed, F115, and was female. All of these relatively common traits may occur due to genetic predisposition, environmental influences or developmental factors, but normally they would be asymptomatic.

Dental remains in cremated skeletons consist largely of fragments of tooth root, small pieces of maxillary and mandibular alveolus, and unerupted tooth crowns. In this group, only 90 fragments of tooth root were identified, none of which showed any signs of dental disease. Seventeen individuals had fragments of maxilla or mandible for which the area of dentition could be identified. These fragments included 101 tooth positions, of which 88 belonged to adults. Ten positions in five adult individuals were closed, showing that the teeth had been lost ante-mortem. An 11.5% prevalence for this condition is relatively high, but may be related to preservation since a closed alveolus is less fragile and therefore more likely to remain intact for identification. Twenty-three unerupted deciduous and permanent crowns were also present, again with no signs of disease. No traces of abscesses or carious lesions were identified in any of the fragments.

Pathological lesions were noted in 22 burials. The majority consisted of relatively minor degenerative changes, largely in the form of osteophytes on fragments of vertebral facets and bodies, and occasionally on other joints.

Some individuals provided evidence of more chronic degenerative disease. F114, a middle-aged/old male, had Grade II osteoarthritis of the anterior right acetabulum (hip joint) and at least one facet for a rib head on a lower thoracic vertebra, as well as osteophytosis of most of the lower spine. F128, an unsexed older adult, had Grade III osteoarthritis on the left facet for the rib head of one thoracic vertebra, osteophytosis of the spine, and lipping of the acetabulum, iliac crest and linea aspera. Grade II osteoarthritis of the medial clavicle was noted in F135, a middle-aged/old male, along with osteophytosis of the neck and lower spine, knee and hip joints, and lipping of the iliac crest and linea aspera. An adult toe phalanx in F162 showed Grade II osteoarthritis at the proximal end. Grade II/III osteoarthritis was present in the elbow of F165, a middle-aged or older adult, with eburnation of the proximal radius joint. F179 exhibited lipping of the linea aspera. F181, an unsexed older adult, appeared to have been affected by osteoporosis, and also had possible osteoarthritic changes to the distal end of one toe phalanx. Grade II osteoarthritis was present in one vertebral facet of F182, an old male, who also had large osteophytes at the femoral head and on one lumbar vertebra. F192, which contained two adults, included fragments of thoracic and lumbar vertebrae with large osteophytes, new bone growth on the linea aspera, and lipping of the right scapula glenoid joint. Middle-aged/old male F198 also had lipping of the linea aspera and medium osteophytes in the spine and the sacro-iliac joint.

Proliferation of new bone at sites such as the iliac crest and linea aspera, together with very large osteophytes favouring one side of the spine, are symptoms associated with diffuse idiopathic skeletal hyperostosis (DISH). Some or all of these lesions were noted in five of the above individuals (F128, F135, F179, F192, F198). DISH is a condition which affects men more than women, occurs most commonly after the age of 50 years, and is associated with obesity and late-onset diabetes. The evidence in this group has to be considered tentative, however.

Periosteal new bone growth, indicating an inflammation of the soft tissue surrounding the bone, was found on fragments of tibia in F59 and F198. This type of periostitis is a common finding in archaeological populations. Its causes are often non-specific, although more severe cases may be related to infections such as leprosy, or secondary to trauma in the affected area. An unidentified fragment from F128 also appeared to show inflammatory changes in the form of rapid new bone growth, perhaps due to an infection or arthritic condition. A small fragment of skull in F198 showed signs of new bone growth, but again the cause was uncertain.

Trauma, in the form of small exostoses which are probably indicative of torn muscle attachments, was seen in two individuals. F114 had a small exostosis (approx 7mm long) on a fragment of femoral shaft. A fragment of distal radius from L1 (350) had a small exostosis above the medial facet, possibly an ossified haematoma.

Osteochondritis dissecans, a condition associated with physical stress, was present on the distal right humerus medial facet (elbow) of F200, a ?young ?male. The lesion was oval, pitted and shallow, but probably unhealed, and measured 11 x 5mm.

Schmorl's nodes are a common lesions which affect the vertebral bodies and result from physical stress on the intervertebral discs. A few individuals had near-complete vertebral bodies in this group, but only one, F134, showed signs of the condition. It was present in the lumbar vertebrae and most of the lesions were large. This individual also had osteophytosis of the lower spine.

Note on the animal bone

Small quantities of animal bone were identified in 23 of the burials and five other features/layers, a total of 398.6g. The largest groups were from F134 (93.7g), F135 (52.4g) and F114 (47.2g). In several cases, the fragments were easier to identify than normal due to condition and colouring. Several pieces were bright white externally and blue-grey or black internally, and showed signs of abrasion. This may indicate that they had been cooked prior to cremation. No attempt was made to identify the bone in detail, but it was clear that the main meat-bearing species (cow, pig, sheep) were represented, and in one burial (F162) several unburnt fish vertebrae were present.

Summary and discussion

A total of 70 groups of cremated bone of varying sizes was analysed. Of these, 39 were urned or probable urned burials, one was a boxed cremation burial, two were possible *busta*, ten deposits were unurned or pyre debris, and the remainder were from other features or layers. The groups represented a minimum of 55 individuals. Six burials contained fragments of a second individual, but two of these had such small amounts that only four could be considered as 'double burials'.

The group as a whole contained three infants, seven children, three sub-adults (two male, one female), twelve adult males, eleven adult females and seventeen unsexed adults. Almost half the adults could not be aged, but, of those which were, the majority were middle-aged or older. The four double burials contained two children in one, a child and an unsexed older adult in another, and two adults in two burials. The spread of ages and sexes seen at this site is similar to other contemporary groups in the south-east of England.

Apart from the degenerative changes which affected most of the mature and older adults in this group, few pathological lesions were identified. It is possible that some of the individuals suffered from diffuse idiopathic skeletal hyperostosis, but the evidence was slight. A few insignificant infections of the bone and some minor traumatic injuries were present, but nothing unusual was noted.

It is possible to suggest some interpretations of the osteological evidence with respect to pyre technology and ritual. Unurned cremation burials in this group were few, and difficult to distinguish from pyre debris, although at least two were complete enough to be burials and were perhaps originally deposited in organic containers. The evidence from the two possible *busta* was difficult to interpret. Whilst one of them may have been burnt and deposited *in situ*, the lack of any pyre material cast some doubt on its identification as a burial of this type. The other showed no evidence for collapse of the pyre *in situ*, and should probably be considered an unusual form of unurned burial.

The majority of burials had been placed in a non-perishable container. None of those excavated were in close enough proximity to suggest that the remains of a single individual were deposited in more than one urn. Based on total bone weights, it is clear that post-cremation collection of bone in this group, like other Roman groups, was far from complete. It has been suggested that collection was simply token, with a few fragments of each part of the body being buried, and the remainder being either disposed of with the pyre debris or removed for other purposes, such as a *memento mori* or perhaps even kept to add to future cremation burials. The latter may explain some of the burials found with a few fragments of a second individual, although, if this were the case, then clearly it was not common practice. More likely is that these odd fragments were incorporated accidentally from re-used pyre sites. The lack of skull fragments in some burials has been attributed to retention of pieces of the head by relatives, but it could just as easily be the result of general carelessness of the collector. The cremation process also appears to have been less efficient than it could have been, based on colouration of the bone, but this is a common finding at Roman sites.

It is interesting to note, in connection with the possibility of retention of fragments of skull or other body parts, that the two double burials which each contained a pair of adults both contained fragments of very white, abraded skull. This was similar in condition to some of the animal bone identified in other burials, but was certainly human. During analysis, the two burials appeared similar enough to be the remains of the same two individuals spread between two vessels, but they were buried at some distance from each other so this now seems unlikely. The presence of abraded skull of a second individual could, perhaps be explained by accidental collection from a re-used pyre, but in F195 it seemed to make up the majority of the collected bone. It is equally possible that the abraded bone in both cases was retained from an earlier cremation and later deliberately added to the pyre of a loved one.

Study of the relative proportions of the main areas of the body within urns excavated in spits showed that generally there was no structured approach to collection of bone and/or filling of the container. There was one exception, which seemed to show that collection started at the head end and worked down the body. The most common pattern was to find similar proportions of the main body areas distributed throughout the urn, and this might be expected to occur if more than one person was involved in collection. This, combined with evidence of poor collection, inefficient cremation of many of the burials and probable re-use of pyre sites, would appear to support the presence of specialist undertakers performing cremation rites in Roman Colchester.

7.7 Inhumed human bone

by Sue Anderson

Introduction

Human remains from eight graves, one possible disturbed burial and seven other contexts were submitted for analysis. A full catalogue of the inhumed human bone can be found in Appendix 4.

Method

Measurements were taken using the methods described by Brothwell (1981), together with a few from Bass (1971) and Krogman (1978). Sexing and ageing techniques follow Brothwell (1981) and the Workshop of European Anthropologists (WEA 1980), with the exception of adult tooth wear scoring which follows Bouts and Pot (1989). Stature was estimated according to the regression formulae of Trotter and Gleser (Trotter 1970). All systematically scored non-metric traits are listed in Brothwell (1981), and grades of cribra orbitalia and osteoarthritis can also be found there. Pathological conditions were identified with the aid of Ortner & Putschar (1981) and Cotta (1978).

Number of individuals

The articulated remains represented a minimum of eight individuals. One feature produced bones which were thought to be a disturbed burial and were all from one individual. Disarticulated remains from four of the other features may belong to three of the more complete burials, but the other contexts are likely to represent a further three individuals. The total minimum number is therefore twelve.

Condition

Most skeletons from this site were in poor condition and many were incomplete due to the nature of the excavation (footing and service trenches only). All had some degree of surface erosion and fragmentation. The best-preserved and most complete skeleton was from F171(Grave 8), although this was lacking the skull.

Demographic analysis

The age and sex of the eight articulated and one disturbed skeletons are listed in Table 21.

Table 21: age and sex of articulated skeletons.

Grave	Feature	Sex	Age
1	F1	Male	Young/middle-aged
2	F31/F39	Male	Middle-aged/old
3	F40	Female?	Adult
4	F119	Male	Young/middle-aged

5	F154	Male?	Middle-aged/old
6	F158	Unsexed	Adult
7	F159	Unsexed	Young
8	F171	Male	Young/middle-aged (approx 30)
9	F208	Female?	Middle-aged/old

No juvenile bones were found. The articulated remains consist of four males, one possible male, two possible females and two unsexed individuals. The disarticulated remains add a further two males and an unsexed individual. The sex distribution at this site is clearly biased in favour of men, but as the group is small and scattered, this may not be significant.

Of those adults to whom an age range could be assigned, one was 'young', three were 'young/middle-aged', and three were 'middle-aged/old', suggesting a fairly even spread.

Metrical and morphological analysis

Cranial and mandibular measurements could be taken for one adult individual and post-cranial measurements for five. A full list is included in Appendix 4. The cranial index could be calculated for only one individual F119 (Grave 4) at 81.0, which is in the brachycranial (broad-headed) range.

Platymeric and platycnemic indices were calculated and are recorded in the appendix; the significance of these indices, which show the relative antero-posterior flattening of the femur and transverse flattening of the tibia, is uncertain. In this group, all measurable bones were towards the broader end of the ranges.

Stature could be estimated for four individuals, all male. They ranged from 164.3cm to 173.5cm (5' 5" to 5' 8") with an average of 168.9cm (5' 6"). This is within the normal range for Roman men.

Non-metric traits were scored for six skulls and six post-cranial skeletons. A list is included in the Appendix. Nothing particularly unusual was seen. It is possible that both F31 (Grave 2) and F154 (Grave 5) had small ossicles at the lambda, which could suggest a relationship between the two men. Both individuals also had unusually thick skulls. They are not buried in close proximity however.

Dental analysis

Five individuals had full or partial dentitions. If all teeth and alveoli were present, a total of 160 positions could be studied. From this total, 64 positions must be deducted because they were missing, and sixteen teeth were present without the alveolar bone, leaving 80 positions which could be assessed for ante-mortem tooth loss and alveolar abscesses. In addition, twelve teeth had been lost post-mortem and seventeen ante-mortem, and two were unerupted or congenitally absent, leaving 64 teeth. A further three positions (one ante-mortem loss, one post-mortem loss and one tooth remaining) can be added from the disarticulated remains.

The eighteen teeth lost before death give a prevalence for this condition of 21.7%. This is very high, and is a result of the small size of the group. Ante-mortem tooth loss had affected most of the mandibular teeth of F154 (Grave 5) (maxilla not present), four upper teeth of F119 (Grave 4), and one lower premolar of F1 (Grave 1).

Five carious teeth were observed, a prevalence of 7.6% in the erupted teeth. These were seen in two individuals, F119 (Grave 4) who had three advanced lesions in the upper right premolars and first molar, and F154 (Grave 5) who had small lesions in the lower right second and third molars (his only remaining teeth). Where it was possible to determine the origin, most of these lesions had developed interstitial-cervically, at the point where food would be trapped between the teeth. One small occlusal lesion was present in the third molar of F154 (Grave 5).

Four alveolar abscesses were present, a prevalence of 4.8%. Three were in the upper left molar area of F119 (Grave 4), and the teeth had been lost as a result. One was in the mandible of disturbed burial F208 (Grave 9), at the left second premolar, which was probably also lost ante-mortem.

Although the dental disease prevalences in this group are high, this is in part a result of the small number of individuals available for analysis. However, the general pattern suggests that the group had a diet rich in carbohydrates. Progression of dental disease appears to have followed the expected pattern, with moderate to large carious lesions opening the pulp cavities of the teeth and allowing abscesses to form around the root, resulting in eventual loss and closure of the tooth socket.

No calculus was present on the teeth, and this did not appear to have been lost as part of the post-excavation cleaning process, suggesting that some attempt was made to keep the teeth clean. This has been noted in other Roman groups, for example skeletons excavated at Lakenheath, Suffolk.

Very shallow hypoplastic lines were present in the enamel of one individual F159 (Grave 7), suggesting periods of illness or malnutrition between the ages of two and five years. This is a relatively common condition in earlier populations. It could simply be related to a reduced availability of nutrients during the winter.

A similar pattern of dental disease has been noted in other Roman groups from the region, and in general populations at this time suffered greater dental decay and associated conditions than previously or later.

Pathology

Congenital and developmental conditions

Sacralisation of the fifth lumbar vertebra was present in F119 (Grave 4), although this was in poor condition and only assessable on the left side. Other vertebral anomalies included noticeable asymmetry of the fourth and fifth lumbar vertebral arches of F171 (Grave 8), the L4 being larger on the left side, and the L5 larger on the right. This individual also had a cleft defect of the first sacral segment arch. None of these conditions would have produced any symptoms in life.

Additional joints were present between the navicular and calcaneum in both feet of F171 (Grave 8), and both bones were slightly modified to accommodate this extra articulation. The joint surfaces were pitted, suggesting early arthritic changes.

Premature fusion of the right squamosal suture of F119 (Grave 4), affecting the short straight part of the suture which runs above the mastoid process, had resulted in asymmetrical growth of the occipital bone, which was wider on the right side, with deformation of the foramen magnum. This may have caused a slight scoliosis in the neck, but the cervical vertebrae were in poor condition and not assessable.

Degenerative and arthritic conditions

Middle-aged/old male F31 (Grave 2) had several lesions associated with degenerative conditions. There was osteoarthritis of the left hip joint, with eburnation of the femoral head, pitting in the superior part of the acetabulum, and osteophytes around both joint margins. The right hip joint was affected to a lesser degree, with only osteophytes. These lips of new bone growth were also present at the left knee joint and in the left thumb (MC1 distal end). In the spine, they were present on the three surviving lumbar vertebrae, and were particularly large on the left side.

The vertebrae of young/middle-aged male F119 (Grave 4) were in poor condition, but Grade II osteoarthritis was seen in the articular facets of two mid-thoracic vertebrae.

Osteophytes were present on the T11-12 vertebral bodies of middle-aged/old ?male F154 (Grave 5), and were particularly large on the right side, but again the spine was in poor condition and most bones were not assessable. There was also lipping around the left acetabulum. The third to fourth cervical vertebrae had Grade II osteoarthritis of the bodies. The distal end of the right radius was slightly enlarged, especially to the anterior edge of the joint, with osteophytes and pitting peri-articularly, and new bone deposits and areas of very fine pitting on the joint surface. The ulna may also have been affected but is in poor condition. This suggests arthritis of the wrist, possibly as a result of trauma.

As noted above, there was slight pitting on the abnormal joint facets present in the ankles of young male F171 (Grave 8), and these may be pre-arthritic.

Stress lesions and trauma

Schmorl's nodes, lesions which occur in the bodies of vertebrae and are related to physical stress on the spine, were seen in the surviving lumbar vertebrae of F31 (Grave 2), most of the thoracic vertebrae and the first lumbar of F154 (Grave 5), and the mid thoracic to second lumbar of F171 (Grave 8). Several lesions were very large in all three individuals.

A possible case of osteochondritis dissecans was seen in the distal end of the right first metatarsal of F31 (Grave 2). The lesion consisted of a slight depression with large pits in the floor, and it measured 7 x 5mm.

Traumatic lesions in this group were all fairly minor, and most were probably the result of torn muscles. A large exostosis was present on the superior edge of the right navicular of F31 (Grave 2), above the facet for the right cuneiform. An enlarged area with slight new bone growth was present on the medial side of the linea aspera of the left femur of F154 (Grave 5), close the lower end of the insertion for the *Vastus medialis* and the *Adductor magnus* muscles. Exostoses were

present on both clavicles of F171 (Grave 8), just lateral to the insertions of the costo-clavicular ligaments.

A crush fracture of the left talus was seen in F119 (Grave 4). There was flattening and distortion of the posterior calcaneal articular surface (the larger inferior facet) at the lateral edge, with a crack in the joint surface and a pitted area. The calcaneus did not appear to have been affected to any degree.

Infections

There were signs of pitting and striation on both parietals of F31 (Grave 2), which may be the result of a healed inflammation or possibly porotic hyperostosis. This individual also had periosteal graining and thickening of both tibia shafts, mainly medially in the superior half, which is an inflammatory response, possibly due to an infection. A lytic lesion or cyst in the superior right side of the second lumbar vertebral body had resulted in partial collapse and wedging of the bone, but some healing had occurred on the outer surface of the bone, which would have strengthened it to some degree. There must have been a slight scoliosis/kyphosis of the spine nevertheless. This kind of lesion can be associated with tuberculosis, but a radiograph would be required to confirm the diagnosis.

Gross periosteal new bone growth with pitting and graining was present on the right fibula of F119 (Grave 4), particularly in the proximal half, where a lump had formed. The corresponding area of the tibia also showed periostitis to a lesser degree. The fibula was in poor condition, but it is possible that the 'growth' was a result of callus formation following a fracture. Again a radiograph would be required to determine the cause.

Slight periosteal graining was present on the lateral right tibia and medial left tibia of F 154 (Grave 5), and the right fibula shaft appeared slightly enlarged, although there was no pitting.

Miscellaneous

There was slight new bone growth on the inner table of the frontal bone of middle-aged/old ?male F154 (Grave 5). This was similar to hyperostosis frontalis interna, a condition which seems to be associated with the menopause in women, but these lesions do sometimes occur in male skulls with unknown cause. One case seen by the author was associated with Paget's disease of the skull, and this skull is unusually thick, but the diploë and inner and outer tables appear normal.

As noted above (non-metric traits), the skull of F31 (Grave 2) was also unusually thick, but again there was no evidence of Paget's disease. Fragments of another skull, F208 (Grave 9), showed signs of hyperostosis frontalis interna, but this individual was thought to be a mature ?female.

The femoral neck angle of the right femur of F40 (Grave 3) appeared abnormally oblique, a condition known as coxa vara, but the bone was in poor condition and the appearance may simply be a result of post-mortem erosion.

Slight lateral bending of both tibiae of F171 (Grave 8) in the proximal thirds may have resulted in 'knock knee' (genu valgum), a condition which can be acquired or congenital.

The head of F171 was missing, so the two remaining cervical vertebrae (C6-7) were checked for evidence of cut marks. Both bones were well preserved, but showed no evidence for decapitation.

Summary and discussion

Eight articulated skeletons, one disturbed burial and seven contexts of disarticulated remains represented a minimum of twelve individuals. These were seven men, two women and three unsexed adults. No children were present, and the individuals ranged from young to old age. They were spread across a wide area to the north of the site.

In terms of general physical appearance – head and body size, stature – they were within normal limits for the Roman period, but slightly shorter on average than Anglo-Saxon groups. Nothing unusual was seen in the range of non-metric traits present, but a couple of cranial anomalies may indicate a relationship between F31 (Grave 2) and F154 (Grave 5). However, as the number of skeletons is small, it is possible that these traits were relatively common within the local population as a whole.

The degree of dental pathology in this group was quite high, but this was due in part to the small number of individuals available for study. However, a high level of dental disease is the norm in most Roman groups and suggests greater consumption of carbohydrates in this period.

Degenerative disease had affected two older adults in the group, but was also seen in at least one younger individual. Usually this would be expected to occur most frequently in the spine, but in this group very few vertebrae were well preserved. Despite this, evidence was seen for the

disease affecting the spines of all three individuals. Other areas of the body with arthritic changes were the hips, knees, wrists and ankles.

General stresses and strains had caused lesions in the spines of at least three individuals, but most were not assessable due to poor preservation. Torn muscles had also affected three men, one in the foot, one in the thigh and one in the shoulder girdle. A crush fracture in the heel bone of another individual was another stress lesion which is relatively common in early rural populations.

Non-specific inflammatory changes to the shin bones are often observed in skeletal groups, and three individuals were affected in this one. Only one of these showed gross changes, which may have been the result of a secondary infection following trauma.

A possible tuberculous lesion was identified in the spine of a middle-aged/old male. This was the only evidence for any potentially life-threatening illness in the group, and it was healed or healing at the time of death.

7.8 Animal bone

by Julie Curl

Summary

A total of 6.434kg of animal bone, comprising of 352 pieces, was recovered from excavations at the Handford House site. Over 60% of the assemblage was recovered from Roman contexts and these remains included possible feasting waste associated with inhumation and cremation burials. A full list of animal bone can be found in Appendix 5.

Methodology

All of the bone was examined primarily to determine range of species and elements present and the amount of material that could produce measurable, ageable bone. Bones were also studied to determine if bone, horn or antler working was present in the assemblage. A note was also made of butchering and any indications of skinning, hornworking and other modifications. When possible a record was made of ages and any other relevant information, such as pathologies. Counts and weights were noted for each context. No measurements were taken with this assemblage due to the lack of much suitable material. Human bone was identified and briefly reported on in this report and removed from the assemblage for the human bone specialist to fully examine and report on. All information was recorded on the faunal remains recording sheets and inputted into an Excel database for analysis. The analysis was carried out following a modified version of guidelines by English Heritage (Davis 1992). A catalogue of all of the bone context by context is included in Appendix 5.

Results and discussion by period

Table 22: weights, quantities and percentages of animal bone for each period and for undated bone.

Period	Total weight (g)	Total quantity	Percentage of assemblage (by weight only)
Roman	3,927	260	61%
Post-medieval to modern	2,386	239	37%
Undated	122	6	2%

Roman

Context dating to the Roman period produced a total of 3927kg of bone, which accounted for almost 61% of the assemblage. In general, the assemblage was in quite poor condition, fragmentary from butchering and wear and with eroded or porous surfaces. Some material showed signs of canid gnawing, this could mean that the material had lain exposed to scavenger activity for a time before burial or simply that it was from food intentionally given to domesticated dogs.

Several contexts in this period are related to cremations, a pyre/bustum and inhumation burials. F134 produced butchered remains of a Dexter (Celtic short-horn type) cattle metatarsal and a single vertebrae from a small species of fish (possibly mackerel). F162 yielded a single piece of chopped sheep/goat metapodial which had been burnt at high temperature, plus an eel vertebra.

Juvenile equid remains were produced from F171. Both pieces of the equid appear to be part of one juvenile femur, one piece bore a chop mark on the shaft which suggests that it may have been eaten. F31, an inhumation burial in a pit, and F42, an urned cremation burial with pyre debris, both contained fragments of mammal bone, none of which appeared to be burnt. The bone recovered from the remains of a pyre or *bustum* (F47) consisted of a rodent bone. The urned cremation burial in F53 produced eleven bones from a mole, these remains consisted of a jaw, pelvis, skull and limbs, however, given that this is a burrowing animal, the remains of this mole may be intrusive. The inhumation burial F119 produced unidentifiable mammal bone and F181 yielded two fish fragments; a mackerel vertebrae was found in the urned cremation burial in F128. The urned cremation burial in a casket produced a single adult mouse femur; this small rodent is likely to have been a rodent that had simply made it's home in the vessel.

Features F205 and F193 are thought to be a rubbish-pit associated with graveside feasting. The bone from F205 contained a butchered juvenile cattle femur and other butchered mammal remains. F193 comprised of the butchered meat bearing bones of adult sheep and pig, as well as other heavily butchered large mammal fragments. Certainly the remains from these fills include good quality meat bearing bones and lots of butchering is evident so they could be from a feast. The juvenile cattle in F205 could suggest that younger and good-quality meat was consumed.

A single adult fox femur was recovered from the Roman L3 (find no 926). No butchering was observed on this particular bone, but foxes are often produced from Roman contexts and are possibly killed for their fur.

Post-medieval to modern

Post-medieval through to 19th-century and modern contexts yielded 37% of the assemblage, totalling 2.386kg of faunal remains. Much of the faunal remains from this period consisted of unidentifiable mammal remains, many of these from L1. Several contexts produced primary and secondary butchering of cattle and sheep/goat and pig. Two positive identifications of goat were noted, one in L1 (find no 852) in the form of an adult metacarpal and a goat mandible in L36, (find no 899). A very large pig tusk was recovered from L1 (find no 154), the large size of this tusk would suggest a mature male. Sparse remains of equid and bird/galliformes were identified, one of the equid bones, a metacarpal from L19 (find no 317) had been chopped

Human bones were identified from T8, F39 (find no 120); these remains consisted of two adult distal humeri and a section of humeri shaft that joins one of the distal fragments. These remains were recovered from a post-medieval pit that cut a Roman inhumation burial in another pit (F31) and so it is probable that these bones were part of that burial.

Undated contexts

A total of 122g of bone was recovered from undated contexts, totalling just over 2% of the faunal assemblage. The undated material consists of primary and secondary butchering of adult cattle and other large mammal fragments.

Conclusions

Much of the faunal assemblage appears to be derived from both primary and secondary butchering waste. Many remains have been recovered from inhumation or cremation burials and these may be the remains of animal offerings which may have been deliberately placed within the grave, perhaps as sustenance for the journey or they may be the remains of graveside feasting. Many of the animal bones associated with the burials are good quality, main meat-bearing bones, so they could have been joints of meat placed within the grave for the afterlife.

The remains of fox may be from an animal that had been killed for its pelt, as it is unlikely that this animal had been eaten. The mole and the mouse in the assemblage are probably intrusive remains from animals that had burrowed and died underground. Human bones within this assemblage are likely to be from a disturbed inhumation.

7.9 Charred plant macrofossils and other environmental remains

by Val Fryer

Introduction

An extensive series of plant macrofossil samples were taken from pyres, cremation pits and the fills of urns and other vessels, in the hope that these would provide data about contemporary cremation practises, most notably the fuels utilised for the pyres. Urn fills were excavated in spits by the Colchester Archaeological Trust, each spit forming an individual sample which was processed and assessed separately. A total of three hundred and sixteen samples were submitted for assessment.

Methods

The samples were processed by manual water flotation/washover, collecting the flots in a 500-micron mesh sieve. The dried flots were scanned under a binocular microscope at magnifications up to x 16, and the plant macrofossils and other remains noted are listed on Tables 36-54 (Appendix 6). Nomenclature within the tables follows Stace (1997). With the exception of rare fragments of mineral replaced wood, all plant remains were charred. Modern contaminants, including fibrous and woody roots, seeds and arthropod remains, were common throughout.

The non-floating residues were collected in a 1mm-mesh sieve and sorted when dry. Cremated bone fragments and other artefacts/ecofacts were removed for further specialist analysis.

Results of assessment

Plant macrofossils

With rare exceptions the assemblages were characterised by low densities of seeds and other plant remains, although charcoal fragments were present throughout. Of the cereal grains and seeds which were recovered, many were either puffed and distorted or fragmented. None of the legumes retained an intact testa and as a result, identifications were made using size and shape as the principal criteria.

Cereals and other food plants

Cereal grains were extremely rare, occurring as single specimens in only twenty seven samples. Although oat (*Avena* sp.), barley (*Hordeum* sp.) and wheat (*Triticum* sp.) grains were recorded, many grains were too fragmented for positive identification. Cereal chaff was not recorded. Cotyledon fragments of large pulses were noted in a number of samples, and were moderately common in the assemblages from features F42 (sample 152), F53 (samples 224 and 240) and F142 (samples 795 and 796). Large angular seeds, probably of field bean (*Vicia faba*) were noted in eight samples. Other food plant remains were rare, but apple/pear (*Malus/Pyrus* sp.) seeds were noted in the material from pyre F134 (sample 813) along with fragments of damson (*Prunus* sp.) type fruit stone (sample 814).

Wild flora

Seeds of common weed species occurred in approximately one quarter of the assemblages studied. Small legumes were predominant, and although close identification was not always possible, the size and shape of the seeds probably indicates that most specimens were of gorse (*Ulex europaeus*). Although rare, other tree/shrub macrofossils including broom (*Cytisus scoparius*) seeds and hazel (*Corylus avellana*) nutshell fragments, were also recovered. Of the remaining seeds, grasses and grassland herbs including medick/clover/trefoil (*Medicago/Trifolium/Lotus* sp.), ribwort plantain (*Plantago lanceolata*), knotgrass (*Polygonum aviculare*), dock (*Rumex* sp.), sheep's sorrel (*R. acetosella*) and vetch/vetchling (*Vicia/Lathyrus* sp.) were predominant. Nutlets/seeds of wetland plants including sedge (*Carex* sp.) and spike-rush (*Eleocharis* sp.) were recorded from only three assemblages.

Other plant macrofossils

Charcoal fragments were recorded at varying densities from all assemblages, along with small pieces of charred root/rhizome or stem. Other plant remains were rare although occasional culm nodes, fruit stone fragments, seeds and pieces of tuber were noted.

Other materials

Fragments of black porous 'cokey' material and black tarry material were recorded from most contexts. Although most are probably derived from the combustion of organic materials at very high temperatures, some may be tarry products of the cremation process. Small fragments of

burnt bone were present in most contexts, but pieces of un-burnt bone were also noted along with occasional small mammal/amphibian bones and fish bones. Vitriified concretions were common in some assemblages, and although some may be derived from glass artefacts placed with the deceased, the majority were probably formed as a result of the high temperatures during cremation fusing the soil beneath the pyres. Burnt clay fragments were also relatively common. Small coal fragments were noted in many assemblages, but it is considered most likely that the majority of these are intrusive within the contexts.

Discussion

The cremation burial pits (Tables 36-51 and 54)

Samples were taken from approximately 44 cremation burial pits, some of which contained accessory vessels including urns, pots, flagons dishes and bowls. The recovered assemblages are mostly very small, and although charcoal fragments are reasonably common, other plant macrofossils are generally rare. Given the contexts, it is assumed that much of the material present is derived from pyre debris or similar cremation waste, although in most instances there is insufficient to illustrate any specific aspect of the cremation process. However, a small number of samples, ie F42 (find no 152), F44 (find no 178), F142 (find no 795 and 796) and most notably samples from within F53 (Table 5) do appear to contain definite fuel residues in the form of gorse seeds, field beans and fragments of other legumes. It appears most likely that the larger legumes are derived from bean 'straw' which, along with gorse, is known to burn at a very high temperature and would, therefore, make ideal kindling or fuel for a pyre. Other fuels may have included dried grasses and grassland herbs, broom, bracken and hedge scrub, although some of this material could equally be derived from plants burnt in situ beneath the pyres. There appears to be little or no evidence for the deliberate deposition of plant materials on the pyre as offerings to the deceased, and although cereals, nutshell fragments and soft fruit remains are present, they are almost certainly either accidental inclusions or an incidental component of brush wood fuel.

Busta (Tables 52-53)

Fifteen samples were taken from two possible areas of pyre activity (F47 and F134). As is probably to be expected, the composition of the assemblages is essentially the same as those derived from the cremation burial pits, with a low density of cereals, weed seeds, legumes and tree/shrub macrofossils. Bone fragments are reasonably common (particularly small fragments of vesicular material) as are materials possibly derived from artefacts including ferrous and cuprous residues, glass fragments and a small number of iron nails or studs (soil sample find no 814).

Conclusions

In summary, despite the low density of material within the assemblages, a significant quantity of data has been recovered regarding the cremation practises conducted at this site. Although wood probably formed the main component of the pyres, subsidiary fuels almost certainly included gorse, bean 'straw', broom, bracken and dried grasses and grassland herbs. The latter two, which were probably used as kindling, appear to have been pulled up by the roots from areas of predominantly dry grassland, although a small number of plants more particular to damp areas do appear to have been incorporated. Unfortunately, with the exception of a few fragments of mineral replaced wood derived from a box or chest within F120 (soil sample find no 601), nothing remains of any un-burnt plant materials which may have been placed within the various accessory vessels.

It was decided has not to examine the site archive to ascertain if specific fuels were used for groups of cremations, or whether fuel selection was either random or a matter of seasonal availability of material.

7.10 Pollen

by Patricia Wiltshire

The contents of three vessels from inside the amphora burial F137 (the dish, the flagon and the beaker) were analysed for pollen. There was no definite evidence for food or drink but pollen from the following trees and herbs were identified.

Trees & shrubs	English name
Betula	Birch
Quercus	Oak
Herbs	
Apiaceae indet.	Hogweed family
Artemisia	Mugwort
Aster type	Daisy/Hemp Agrimony & others
Asteraceae (fenestrate)	Dandelion-type plants
Chenopodiaceae	Goosefoot family
Plantago lanceolata	Ribwort Plantain
Poaceae	Grasses
Ranunculus type	Buttercups & allies
Trifolium type	Clover and allies
Urtica	Nettle

7.11 Flint

by Hazel Martingell

Ten pieces of worked flint and one natural piece were studied. They consisted of one flake, two blades (one complete and one fragment), four chippings, one retouched flake, one retouched blade and one irregular piece.

The retouched blade (L2, find no 707), blade (F109, find no 447) and blade fragment (*bustum* F47, find no 204) are all good and should be of early Neolithic date. Similar material has been recovered from the Roman River valley south of Colchester. These finds suggest agriculture along the northern side of the valley. It is possible though, that they were collected from farther a-field and re-used during the Iron Age or later. The retouched flake (L12, find no 143) is of interest. It has the typological requirements for later prehistoric flint implements (Clark 1936; Clark 1953) and roughly resembles a scraper. Continuing research suggests that some of these scrapers may also have been used as strike-a-lights. The find spot, in the subsoil sealing the Roman road, could be where it was discarded or lost, unless it came with the subsoil from elsewhere.

These pieces, although few in number, are an important contribution to the information that is being collected about the prehistoric way of life in the Colchester area.

Table 23: list of flint artefacts by context.

Find no	Small Find	Context	Description	Date
17	182	F2, T4	1 flake, secondary	Late Bronze Age-Roman
143	185	L12, Soakav	1 retouched flake, secondary	Late Iron Age- Roman
204		F47, T 15	1 blade fragment, tertiary	Neolithic
205		F47, T 15	1 burnt fragment	
299	156	F47, T 15	1 chipping (core or artefact trimming)	
357	196	F91, T 24	1 natural piece	
447	154	F109, T37	1 blade, tertiary, good	Neolithic
707	170	L2, T56	1 retouched and backed blade, knife/sickle piece, tertiary, good	Neolithic
1003		F141, T94	1 chipping, trimming flake, tertiary	
1157	150	F114, T45 (urn)	1 retouched? Irregular piece	Iron Age- Roman?
1177		F201, T131, urn	1 chipping, trimming flake, tertiary	

7.12 Prehistoric pottery

by Paul R Sealey

Table 24: list of prehistoric pottery by context.

Find no	Context	Description	Date	Weight (g)
355	F80, T34	2 x flint tempered sherds, one with decoration	initial Iron Age (formerly 'Late Bronze Age Decorated'), c 800-600 BC	12
459	L8, T46	1 x flint tempered sherd	?Late Bronze Age/Early Iron Age, c 800 BC +	6
591	F93, T36/3	3 x flint-tempered Deverel-Rimbury sherds	Middle Bronze Age c 1400- 1200 BC	39

7.13 Post-Roman pottery

by Howard Brooks

In total, 4.1kg of post-Roman pottery was analysed from excavations at the Handford House site. The tables in Appendix 7 show the group in two parts: Table 55 shows the medieval and late medieval transitional wares (which form 14.5% of the whole group), and Table 56 shows the post-medieval wares (85.5% of the total group). Fabric descriptions are as in *CAR 7*.

This group is typical of Colchester post-Roman pottery assemblages, consisting primarily of modern ironstones (Fabric 48d - 32% of the total group), and post-medieval red earthenwares (Fabrics 40 and 40bl - 21%). There were smaller weights of modern ironstones (Fabric 45m - 6%), medieval sandy orange wares (Fabric 21 - 4%), flowerpot (Fabric 51b - 4%), early medieval wares (Fabric 13 - 3%), and late slipped kitchen wares (Fabric 51a - 4%).

Much of this material is from topsoils, and is not worth detailed comment. However, there is one interesting aspect which is worth highlighting. That is the large amount of medieval pottery from this out-of-town site. It would be normal to recover large volumes of material from the town and its immediate environs, but this site is some distance from the walled town. The total weight of Fabrics 13, 20 and 21 is 457g (11% of the group). If the Colchester-type wares are added (Fabric 21), then this group amounts to 501g (12%). This is some way ahead of the quantity of medieval pottery which would be expected on an open field, with the finds deriving from manure scatter. The average weight of manure scatter medieval pottery in Essex is almost exactly 25 grammes per hectare (figures kindly provided by Mark Germany of the Essex County Field Archaeology Unit). The implication must be that there is a local source of medieval pottery from the 12th century onwards; whether this was a farm nearby or a property on the Lexden Road frontage is not clear.

7.14 Roman brick and tile

by Ernest W Black

The table below shows the identifiable fragments of tile found in Roman (including uncertain Roman) and post-Roman contexts. Doubtful fragments, eg tiles with a thickness of approximately 25-28 mm which might come from either bricks or *tegula* bases, have not been included. A complete catalogue of Roman tile can be found in Appendix 8.

Table 25: types of Roman tile.

type of tile	amount from Roman contexts	amount from post-Roman contexts
box-tiles		14 (6 burnt)
bricks (thickness 28-42mm)	5 (3 burnt)	73 (21 burnt)
bricks (thickness 43>mm)	2 (1 burnt)	2 (1 burnt)
<i>imbrices</i>	7 (1 burnt)	35 (3 burnt)
<i>tegulae</i> (thickness>20mm)	25 (1 burnt)	76 (16 burnt)
<i>tegulae</i> (thickness 21>mm)	13 (3 burnt)	27 (8 burnt)
<i>tesserae</i>		7
voussoir	1	
Totals	53 (9 burnt)	234 (55 burnt)

The overall proportion of burnt tiles in the two groups is not dissimilar. There are few tiles that are intrinsically datable. The voussoir (find no 926) from L3 is a type produced c AD 125-50 (Black 1995, 1279-81). The combed box-tiles will not be earlier than the 2nd century. Study of *tegula* bases from the Co-operative Society's store site in Colchester showed that they decreased in thickness over time, with those deposited in contexts dating before the late 2nd century having a thickness greater than 20 mm, and tiles less than 20 mm only appearing from the late 2nd century onwards (Black 2000). While this cannot be taken as an absolute, it can be used as a chronological guide. Only two *tegula* bases were found in fairly closely dated contexts at the Handford House site: from F130 (find no 657), dated 1st-2nd century, came a base with a thickness of 23 mm and from F137 (find no 680), dated early 2nd to mid/late 3rd century, came one with a thickness of 17-19 mm. This is at least consistent with the findings from the Co-operative Society's store site. On this basis very little of the tile from Roman contexts need have reached the site before the late 2nd century and this would suggest that it was probably not a regular component in the structure of cremation pyres or in other aspects of burial before this date. The relative paucity of bricks in Roman contexts, and the absence of box-tiles and *tesserae*, is significant, since these are elements used in the structure of the walls and floors of substantial buildings and would only usually become available as a result of rebuilding or demolition, whereas roof-tiles might be available after running repairs to a structure. It can be tentatively suggested that the majority of the Roman tile reached the site in the late Roman period (and was then redeposited in later contexts) or in the post-Roman period. The source of the tile might be a nearby Roman building or the Roman town itself, from which soil and rubbish might have been brought to be dumped at any time.

7.15 Clay pipe

by N Crummy

Clay tobacco pipes were identified and are listed in Appendix 9.

7.16 Textile

by J P Wild

Textile from casket cremation burial F120 (find no 559), Small Find 71 was analysed. Nine scraps of the same 1/1 plain-weave cloth (no more than 6 sq cm in all) were examined. Attached to the inside of one of the box fittings, they had been mineralized by the oxides leaching from the ironwork which had also coated the back of each piece (Janaway 1983). In one fragment there were two layers of fabric rather than one. The data from the largest piece was as follows:

System (1): medium Z-spun (10-20°), c.16 threads per cm, maximum length 18mm, regular spin.

System (2): medium Z-spun, c 16-18 threads per cm, maximum length c .15mm, regular spin, but some slightly thicker yarns.

Under the microscope, the visible character of the fibre strongly resembles wool. Described as a 'balanced tabby', medium weight good-quality wool cloth of this type was a standard product of the Romano-British textile industry (Wild 1970, 46; Wild 2002, 14, 18-19). Its original function is obscure: while it would have been suitable tunic material, as parallels from Vindolanda suggest, in this context it was arguably in secondary use, perhaps as the container for cremated bone.

7.17 The graffiti on the amphora from cremation burial F13

by Ernest W Black

An amphora (F137.1) containing a cremation burial dated to the second half of the 2nd century carries two adjacent symbols. That to the right is deeply cut and may have been made pre-firing. That to left is less deeply cut and was probably made after firing. It is a leaf-stop, used to separated words in a monumental inscriptions, and rarely on pottery (*RIB II.8*, 2503. 398 where the leaf-stops seem to have been added to give emphasis to the work they flank).

That to the right was possibly cut before the amphora was fired and could have been intended as the letter V or A or the number 5. Its original significance is therefore unknown. When the leaf-stop was added its alignment shows that the symbol was intended to be read as A. Presumably this was the purpose of adding the leaf-stop. The A was perhaps intended to be an abbreviation of a significant word or name.

There are parallels for the letter A cut after firing on pottery from burials from other sites in the south-east of England. The closest, geographically, comes from burial BF6 at Bellhouse Quarry, Stanway, Colchester and dates to the mid first century AD. There a samian cup carries /Λ, another form of A (Crummy *et al* 2007). Another samian vessel from Baldock in Hertfordshire carries /λ (=A) and a cross, as well as the personal name MELENIO[S]. A and AN (ligatured) occur on vessels in burials at the Ospringe cemetery in Kent (Whiting *et al*, 1931, plate LII) and on others, unpublished, from the cemetery at Walls Field, Baldock (Westell 1931), sometimes combined with a cross.

The regulated occurrence of such graffiti in burial contexts in south-east England suggests that they may have some funerary significance. The following possibilities can be suggested, though they are not provable at present and will remain so unless and until a full version of the A - name is found.

The Celtic word andumnos (or antumnos) occurs in a Gallic text from Larzac near La Graufesenque and seems to have had the sense of 'very deep' and was used to mean 'the underworld' (Meid 1994, 40). The A inscribed on pots from burials may have stood for this or some derivative word. A possible Latinized version of this is found on a vessel from a burial at Skeleton Green, Hertfordshire, reading ORKI VOT[VM], 'a vow for Orcus' (*RIB II.7*, 2501.20), with Orcus, a Roman name for the underworld, standing for the god of the underworld.

The second possibility is that the A stood for the name of a particular underworld god. A Purbeck marble slab, now lost, which came from the area of a Roman cemetery on the the south-west side of Colchester (and therefore from the same area as the the Handford House site burials) read: 'To the Deities of the Emperor and to the god Mercury Andescociuoucos, Imilco, freedman of Aesurilinus, from his own resources gave this alter in marble' (*RIB I*, 193). The Greco-Roman Hermes/Mercury was the escort of the souls of the dead to the underworld and was the patron of money-making and wealth. It seems likely that Mercury was here identified with a Celtic god who embodied one or both of these aspects. Although this god is only recorded from Colchester and we have seen that the use of A (and occasionally AN) on pottery from burials is much more widespread, a possible link is provided by *RIB II*, 8, 2503,130 from a late first century context in London, admittedly not a burial. This reads MIIRC[...]\Λ and it is possible to expand this to Merc[urio] A[...], perhaps A[ndescociuoucos].

7.18 Miscellaneous finds

A list of stone, charcoal, slate and slag etc was made and can be found in Appendix 10.

8 Discussion

8.1 Pyres and the cremation process

Toynbee, using classical texts as sources, describes a typical Roman cremation where the pyre (*rogus*) was made of a rectangular pile of wood on which the corpse was laid (possibly lying on a couch), accompanied by various gifts and some personal possessions or pets. When the pyre was lit, the attendants, usually the family of the deceased, would throw oil and perfume onto the fire along with food and ornaments. Animals were sometimes sacrificed. After the body had been cremated, the flames were doused with wine and the relatives would then collect up the bones into the receptacle for burial elsewhere (Toynbee 1971, 49-50).

However, caution needs to be exercised when using this as a model, as the ancient authors mainly describe heroic or public funerals in Greece or Rome, for example, Homer (*Iliad*, 23), Festus (*Vespae*), Suetonius (*Augustus*, 100), Pliny the Elder (*Natural History*, 35), Virgil (*Aeneid*, iv.684, v.77, vi.177, vi.215, vi.225-9, ix.215, x.519, xi.143, xi.188). Geographical and class variations in cremation of the dead must have occurred. Archaeological excavation helps to 'fill in the gaps' left by ancient authors, especially concerning the process of cremation, eg fuel, furniture, artefacts and ecofacts burnt on the pyre.

Evidence for the cremation process was recovered from three different types of feature at the Handford House site; two pyre sites, several pyre-debris deposits, and the cremation burials. Both pyre sites excavated were *busta*, a type of pyre site not previously recorded in Colchester. *Busta* vary from standard pyres in that the cremated bone and remains of the pyre have been allowed to fall into the oblong pit below, which forms the grave. In a *bustum*, therefore, it would be expected that the majority of the bone would be present as it would not have been picked off for re-burial. It would also be expected that the bone would have stayed in roughly anatomical order. The first pyre (F47) conforms to this model; however, the second pyre F134 is less clear. At the Handford House site, what remained of each pyre was an oblong pit (possibly dug to aid ventilation as well as to receive the remains) with a very blackened fill. Scorching produced reddened earth around the edges, indicating that a fire had been lit over the pits. A wooden pyre or *rogus* would have been erected above the pit and the body of the deceased laid either below or on top of the pyre. Charcoal from the *rogus* and cremated bone from the body would fall into the pit as the fire burned. Some of the pieces of bone were quite large, suggesting either that the cremation burial process was not very efficient or that perhaps it was never completed, for some reason. The bluish hue of the cremated bone in F47 points to incomplete oxidation, ie with a temperature of less than 600°C being achieved. It is often observed with Roman cremations that the cremation process was less efficient than it could have been (see section 7.6).

Sue Anderson is of the opinion that F134 is not a *bustum* but an unusual form of unurned cremation, due to the jumbled nature of the cremated bone within the pit (see section 7.6). However, it is the view of the author that F134 is a *bustum*, due to the size of the pit, the large amount of cremated bone present, and the scorching around the top of the pit. Moreover, between ten and twelve probable *busta*, similar to F134, have since been excavated at Area J1 North of the Colchester Garrison Urban Village site (CAT Report 412). There the oblong pits were also scorched and contained large quantities of cremated bone which was not in anatomical order. These *busta* may provide an interesting comparison to those found at the Handford House site. They appear to be similar to F134, ie the bone is jumbled within the pit, as if there had been some shovelling of the bone and pyre debris into the pit below. There is also a similar proportion of *busta* to other cremation burials at both sites (approximately 1:30).

Although charcoal was present in both of the *bustum* pits at the Handford House site, more charcoal would be expected. An explanation may be that the land surface has been truncated horizontally, thus removing a layer of charcoal. This was noticed at pyres in the Skeleton Green excavation in Hertfordshire (Partridge 1981, 294). The bodies may have been placed under the *rogus* rather than on top, which means that the charcoal would be the first thing to be removed by any ground truncation (Hall 1959, 15-16).

Cremation using *busta* is a tradition more commonly seen on the Continent in the Roman period, and it is associated with large settlements and military centres. It is a practice likely to have been brought over by the Roman army (Barber & Bowsher 2000, 309; Struck 1993, 91-2). Other *busta* found in Britain include a probable example from the eastern cemetery of Roman London which was a 1.8 m-long, 1 m-wide and 680 mm-deep pit. The bottom 300 mm of fill was charcoal,

cremated bone and pyre goods. The top 20 mm of the pit was reddened. The position of the individual bones was not recorded, but 835g of bone was recovered in total, which does not represent a complete individual. Although all the skeletal elements were represented, it is not thought that they were in anatomical order in the pit. This *bustum* is dated to AD 180-300 (Barber & Bowsher 2000, 62). A probable *bustum* was excavated at 165 Great Dover Street, Southwark which is part of the southern cemetery of Roman London. This late 1st-century AD *bustum* was found next to mausolea and walled cemeteries. The pit was 800 mm wide and over 1 m long, and there was no scorching. Its fill contained cremated bone from a female and an exceptional array of charred plant remains of nuts, dates, figs, almonds, cereals and a complete chicken burnt on the pyre. These are thought to have been the raw ingredients of a meal. Also included were eight ceramic lamps, eight *tazze* and melted glass (Mackinder 2000, 10-13).

In St Albans (Roman Verulamium), ten supposed *busta* were excavated at St Stephen's cemetery (4-6 King Harry Lane). The *busta* there were charcoal-filled pits of similar dimensions to F47 and with in situ burning on their upper margins. However, the excavators found less than half of the expected bone weight in each undisturbed *bustum*, and they deduced that there may have been more to the cremation and burial process than is normally assumed (Barber & Bowsher 2000, 62; Frere 1987, 329). Other *busta* have been recorded at military centres in the north of England, especially in the vicinity of Hadrian's Wall (Struck 1993, 91).

Only two *busta* were recorded at the Handford House site, yet there were 57 cremation burials, which suggests that other pyres must have existed nearby. These could have occupied a separate area to the burials, as was the case at the Late Iron Age cemetery at Elms Farm, Heybridge, near Maldon in Essex (ECC 2002a, 9). Classical authors such as Virgil and Festus describe a '*ustrinum*' as a place definitely reserved for cremation of the dead (Toynbee 1971, 49). Thus the *ustrinum* for the cremation burials at the Handford House site may still await discovery. Alternatively, it may be that pyres other than *busta* were once present on the site but left only shallow evidence which has been lost. This was the case in Enclosure 3 of the site at Stanway Quarry, Colchester (Crummy *et al* 2007). If pyres were built straight onto the ground without a pit, later ground truncation would leave little surviving evidence (Barber & Bowsher 2000, 61). The presence of urned cremation burials with the *busta* in this cemetery indicates that at least two cremation rites were being practised here concurrently in the 1st-2nd century; the standard re-used pyre site where the bone was picked off and buried, usually in a container, and the *busta*, where the remains were left *in situ*.

Small quantities of cremated animal bone were identified in some of the cremation burials and in one of the *busta* at the Handford House site, indicating that food was burnt on the pyre with the body. The largest groups were from F134, F135 and F114. Several pieces were bright white externally and blue-grey or black internally, and showed signs of abrasion. This may indicate that they had been cooked prior to cremation (see section 7.6). F134 produced butchered remains of a Dexter (Celtic short-horn type) cattle metatarsal and a single vertebra from a species of small fish. F162 yielded a single piece of chopped sheep/goat metapodial which had been burnt at high temperature, plus an eel vertebra; F181 yielded two fish fragments; and a mackerel vertebra was found in the urned cremation burial in F128 (see section 7.8). The type of animals represented would be more likely to be food offerings, rather than pets of the deceased which some classical authors have referred to (Walker 1985, 57).

The environmental report shows little or no evidence for the deliberate deposition of plant materials on the pyre as offerings to the deceased, and, although cereals, nutshell fragments and soft fruit remains are present, they are almost certainly either accidental inclusions or an incidental component of brushwood fuel (see section 7.9).

The small finds, Roman pottery and Roman glass reports provide further information about other goods placed on the pyres. Roman glass unguent bottles or the remains of them, which seem directly related to funerary activities, were found in eight cremation contexts and one *bustum*. These vessels originally held oil, probably perfumed. In general, the use of vessel glass in funerary ritual at the Handford House site follows the normal pattern observed in the other Roman cemeteries surrounding Colchester in the mid 1st century.

Bustum F134 suggests that secondary grave goods could be added to a *bustum* after the ashes had cooled. Fragments of an unburnt flagon were mixed in with the cremated bone as were an unburnt hand mirror and unburnt copper-alloy spoon. The Colchester Garrison Area J1 North

busta also featured unburnt pottery and lamps which had been added to the cremated remains after cremation.

There was evidence of wooden boxes being placed on the pyre with the deceased. The *busta* and pyre debris from cremation burials commonly contained iron nails. The smaller examples of nails may have come from boxes or similar small wooden objects placed on the pyre as grave goods. Two cremation burials contained burnt copper-alloy box fittings from boxes which had been placed on the pyre.

Individuals are likely to have been cremated fully clothed and wearing shoes, the evidence for this being the copious amounts of hobnails in the pyre debris. There was no evidence for shoes being placed next to the cremation vessel within the pit. Two cremation burials contained a burnt bead which may have formed part of necklaces worn at cremation.

The two *busta* and one of the cremation burials (F199) contained scorched coins which had been burnt on the pyre. In *bustum* F47, the coin was found at the head end of the pit. It is likely that these coins were placed in the mouths or on the eyelids of the deceased prior to cremation. This Roman custom was connected to the belief of needing to pay the ferryman to take the deceased across the mythical river Styx to the afterlife.

Burnt broken pottery was found in several cremation burials and the two *busta*. Whether this was deliberately smashed after cremation is hard to verify. Burnt fragments of three *tazza* vessels were present in one cremation burial (F19). *Tazze* are usually thought to be incense burners and thus might suggest the use of incense in the cremation process (Philpott 1991, 193). It is not clear whether the burning was caused by the pyre or through the burning of incense.

The study of the plant macrofossils from the site gives an indication of what the pyres were made of. Although wood probably formed the main component of the pyres, subsidiary fuels almost certainly included gorse, bean 'straw', broom, bracken, dried grasses and grassland herbs. Bean 'straw' and gorse are known to burn at a very high temperature and would, therefore, make ideal kindling or fuel for a pyre (see section 7.9).

Study of the cremated bone provides evidence for how the 'bone was picked off the pyre. Analysis of the relative proportions of the bone representing the main areas of the body within cremation urns which were excavated in spits showed that, generally, there was no structured approach to the collection of bone and/or filling of the container. There was one exception, which seemed to show that collection started at the head end and worked down the body (F178). The most common pattern was to find similar proportions of the bone representing the main body areas distributed throughout the urn, and this might be expected to occur if more than one person was involved in collection. There was very little charcoal inside the urns, which indicates that the bone was carefully picked off the pyre rather than swept off with other material.

It is clear from the weight of the bone recovered at the Handford House site that the amount of bone collected for burial was far from complete, as at other Roman cemeteries around the country (section 7.6). It has been suggested that collection was simply token, with a few fragments of each part of the body being buried, and the remainder being either disposed of with the pyre debris or removed for other purposes (see section 7.6). The deposition of pyre debris in separate pits or hollows is a phenomenon which has been recorded at the Handford House site, as at various other recently excavated Late Iron Age and Roman cremation burial sites such as Stanway Area D, Colchester (Crummy et al 2007, 400-422); Elms Farm, Heybridge, Essex (ECC 2002a, 9) Westhampnett Bypass in Sussex (Fitzpatrick 1997 71) the eastern cemetery of Roman London (Barber & Bowsher 2000, 60-63 and 265); Atlantic House, part of the western cemetery of Roman London (Watson 2003, 43); Great Dunmow in Essex (ECC 2003, 7); and Colchester Garrison Urban Village (CAT Report 412). Pyre-debris deposits are difficult to differentiate from unurned cremation burials (McKinley 2000a, 265). In pyre-debris deposits, the recovery of bone is incidental and it is mixed in with other pyre debris, usually without any layering or grouping of the bone. They are also characterised by very black, charcoally fills.

Between 11 and 15 cremation burials contained deliberately-deposited pyre debris in the pit fill. This consisted of small fragments of cremated bone, charcoal and artefacts such as melted glass unguent bottles, burnt pottery, nails from wooden boxes, lamps, coins, jewellery, a bone needle, a bone die and hobnails. This material was burnt with the body on the pyre and deliberately placed

with the cremation burial. The deliberate reburial of the pyre debris separately is being increasingly recognised during the excavation of Late Iron Age and Roman cemeteries elsewhere in the country (Fitzpatrick 1997). The pyre debris must have had some significance to the mourners, but what purpose its reburial served and whether it was purely a symbolic act is uncertain.

8.2 Cremation burials

The excavation provided information on burial rites as well as cremation rites. Of the 57 cremation burials, 35 were definitely urned. The cremation urn was commonly a ceramic cooking or storage jar, but, in one cremation burial, the bone was contained within a glass jar (F126) and, in another cremation burial, the bone was in a wooden jewellery box (F120). Eleven cremation burials may have been urned but the level of disturbance made this difficult to ascertain. The remaining 11 cremation burials have been classified as either unurned or pyre-debris deposits. It was difficult to distinguish between the two due to ground disturbance. Generally, those with a charcoally fill and where cremated bone occurred throughout the fill rather than just at the base of the pit have been termed pyre-debris deposits. Twenty of the urned cremation burials featured one or more ancillary vessels alongside the urn/box; for example, dishes, flagons and small beakers which may have held food and drink. One of the urned cremation burials was deposited in a large Dressel 20 amphora (F137); subsequent excavation of its contents produced a flagon, the neck of the amphora the cremation urn, a lamp and a dish. Pollen analysis carried out on the ancillary vessels from inside this amphora did not provide any definite evidence that they had contained food and drink (see section 7.10). One possible reason for the eating and drinking vessels associated with the cremation urn not holding food or drink is that they may have been symbolic of a meal rather than containing an actual meal.

One urned cremation burial featured a large but broken Verulamium region / Brockley Hill amphora (F204) which may have contained a cremation urn. Amphora burials have been found in Colchester previously, providing ready-made cists for cremated remains (CAR 9, 265-6).

As well as F120, the wooden jewellery box containing a cremation (ie a boxed cremation burial), some other cremation burials also featured or appeared to feature unburnt wooden boxes (?F41, F103, F108, F126, F199). These boxes either contained the cremation urns or pyre debris.

Several of the cremation urns had been covered by lids of varying forms; some were formed out of broken pot bases, others were specially designed lids, and a few were dishes inverted over the mouth of the urn. The lids did not just serve a functional purpose of preventing the backfill from falling into the urn. A dish was probably used as a lid within the amphora burial F137 but the cist had already been sealed by the neck of the amphora, therefore negating the need of a lid for the urn. The use of a lid therefore may have been partly symbolic. The author of the excavations at Atlantic House, the site of which is part of the western cemetery of Roman London, suggests that the lids formed by inverted dishes over the cremation burial may be an act of symbolic feeding of the deceased (Watson 2003, 35).

Lamps are not commonly found in cremation burials in England; however, six complete lamps came from cremation burials at the Handford House site, plus fragments from at least three others. Three of the complete lamps were from cremation pit fills and the other three came from inside urns or inside an amphora (see below). There was compelling evidence for some of the lamps being lit before the pit was backfilled, thereby providing light in the grave for the deceased. In two of the cremation burials (F42 and F53), broken pottery had been placed carefully over the wick end of the lamps in order to shield the flame (Plates 1 and 8). There must have been some kind of cavity to protect the lit lamp from the backfill, perhaps created by a wooden board. Lamps in cremations are most often found in cist cremations or amphora burials which provide a cavity. This was the case with the first amphora burial (F137), where a small lamp was found upside-down within the dish. The dish was found by the side of the urn but had probably been placed on top of it. The lamp was probably flipped over when the neck of the amphora fell in and knocked the contents over. One lamp depicting a comedy mask was discovered inside an urn along with broken fragments of a lid (F128). The lamp could have been sitting on top of the lid originally. Another lamp was found partly inside an urn, on top of a lid (F141).

Some of the designs on the picture lamps may well have been chosen for their funerary symbolism; for example, the lion fighting a crocodile and the stave dancer with the large phallus.

As well as being a guide for the deceased to help them on their journey to the underworld, lamps may have had other functions, such as purification (Philpott 1991, 192-3). Lipid analysis was carried out on five of the complete lamps to ascertain what oil was used; however, no conclusive results were obtained.

Firing defects were noted on three of the cremation urns, indicating that kiln wasters or seconds may have been used as receptacles for cremated bone.

Four double cremation burials were identified from the Handford House site, ie remains from two individuals in one urn (Barber & Bowsher 2000, 109). Two of the double cremation burials were of two adults (these may be the same two individuals spread over two burials), one was of two children, and the other was of an adult and a child. Barber and Bowsher state that the probability of kin relationships or close friendships of those buried together is compelling (Barber & Bowsher 2000, 272). It is not known whether the individuals were cremated together or if one was cremated later and subsequently added.

The contents of 100% of the whole cremation urns (25 in number) were excavated by hand, in spits, in order to recover the cremated bone and other items inside. The contents of 12 complete ceramic ancillary vessels were also excavated by hand. Several of the urns were found to contain carefully deposited unburnt items alongside the cremated bone. Glass vessels (unguentaria, flasks and a Hofheim cup) were recovered from within the urns from two cremation burials (F42 and F53).

Two urns contained mirrors (F128 and F200), one contained a picture lamp (F128, see above), one contained a beaker and a finger-ring (F162), two contained childrens' shale or bone bracelets and melon beads (F162 and F209), and one contained an unburnt coin (F198); three other cremation unburnt coins but within the pit fills rather than within the urn.

8.3 Inhumation burials

Nine articulated adult inhumation burials were excavated, all of which occupied the northern/north-eastern part of the site. No two inhumation burials were the same; the deceased were buried in different positions and alignments, and only two of them were definitely buried in coffins (F1/Grave 1 and F159/Grave 7). Some were buried in pits, and most were supine, but two were flexed on their sides (F31/Grave 2 and F154/Grave 6). One of the skeletons was a male wearing a shale armband (F119/Grave 4). Another was wearing hobnail shoes (F171/Grave 8). The inhumations are all Roman, but there is no more precise dating evidence from most of the inhumations except for three which contained pottery dating them to somewhere between the mid 2nd to 4th centuries. Two inhumations did contain 1st-to 2nd-century pottery (F1 and F154); however, this may have derived from earlier cremation burials which had been cut by the inhumations. The shale armband may either be Late Iron Age/early Roman or late Roman. Therefore it not possible to surmise whether the two burial practices were being used concurrently or whether all the inhumations are later than the cremations (see below, the phasing of the cemetery).

The orientation of the inhumations or lack of it is worth noting. At the Roman cemetery on the Butt Road site in Colchester, the first phase of inhumation burials were generally aligned north-south and the later (Christian) ones were aligned east-west (CAR 9, 4-202). At the Handford House site, there does not seem to be a pattern, which suggests that they were not Christian.

The gender distribution was weighted towards men, but the sample was small and not in good condition.

It was not possible to establish the religion of the inhumations, specifically whether any were Christian.

The inhumations were mostly 1m below ground-level whereas the cremations were generally shallower. The deeper burial of the unburnt bodies may have been for reasons of hygiene.

8.4 Phasing of the cemetery

The earliest cremation burials date from the mid 1st to 2nd century and some are definitely pre-Boudican, ie the cemetery was in use from the first few years after the Roman invasion of AD 43. The cremation cemetery carried on in what appears to have been continuous use till the 3rd or 4th century as there are cremation burials from the 2nd century and the 3rd or 4th centuries from the site.

Some of the inhumation burials are more difficult to date due to a lack of well-stratified pottery or other datable artefacts. The first inhumation to be excavated (F1) contained a flagon in the grave fill dating to the 1st-2nd century plus a few fragments of early pottery from other vessels. However, it may be that the inhumation was cut through an earlier cremation (one fragment of cremated bone was found within the grave fill). A post-medieval pit cutting through inhumation burial F31 contained 3rd- to 4th-century pottery which probably derives from the burial. The fill of another inhumation burial in a pit contained part of a grey ware jar of the 1st-2nd century, which may be residual (F154). The individual buried wearing a shale armlet (F119) could have died in the Late Iron Age/early Roman period or in the 3rd to 4th century, as such armlets are known from sites of both periods (see section 7.3). The fill of the grave for inhumation burial F159 contained 3rd- to 4th-century pottery. The disarticulated bones from inhumation burial F208 were jumbled together with fragments of a mid 2nd- to 3rd-/early 4th-century pot. The other inhumation burials did not contain any datable material. The fact that the inhumations were grouped together in the north-eastern part of the site suggests that they are contemporary with each other. Whether they are all late Roman cannot be verified, but it seems likely.

In the pre-Roman Iron Age in south-east Britain, the main burial rite was cremation, the population being influenced by the Aylesford-Swarling culture (Philpott 1991, 6). This certainly seems to be true of Colchester; for example, the cremation burials in the Lexden Cemetery and the Lexden Tumulus are all of pre-conquest date (*CAR* 11, 164; Foster 1986). The invading Romans also practised cremation burial, which was used to completely dispose of the body to ensure that the spirit entered the other world and did not return to haunt the living (Alcock 1980, 50). The Romans also brought other burial practices which gained popularity in Britain, such as putting a coin in the mouth or on one of the eyelids of the deceased or into a cremation urn to pay the passage of the dead across the mythical river Styx to the afterlife (*ibid*, 57).

During the mid 2nd century, there began a move away from cremation to inhumation burial, which has been viewed by some as a move towards a greater degree of respect for the dead, with the spirit now entering upon a new life with a complete body (MacDonald 1977, 37; Watson 2003, 7). Toynbee states that this change was too early to be a result of Christian influence but 'would seem to reflect a significant strengthening of the emphasis on the individual's enjoyment of a blissful hereafter' (Toynbee 1971, 41). Walker attributes the change to Greek influence, with the vogue for sarcophagi being spread by Emperor Hadrian across the Continent (Walker 1985, 17). Roman inhumations were usually extended supine burials, often in wooden coffins. The accepted theory is that cremation burial was the dominant rite through the 1st-early 3rd century, with inhumation becoming more prevalent in the 3rd and 4th centuries (Watson 2003, 38). Most of the cremation burials recorded from Colchester are of 1st- and 2nd-century date (*CAR* 9, 257 & 262-4). At the Butt Road site cemetery, which was in use from the 3rd to early 5th century, only five cremations were found and these probably date from c AD 200. The rest of the burials (over 700 in number) were all inhumations (*CAR* 9, 4, 13, 27). Recent excavations at the St Mary's hospital site in Colchester revealed approximately 80 burials, almost all of which were inhumations from the 3rd-4th centuries (CAT Report 484 forthcoming). The changeover to inhumation in Colchester seems to have occurred between AD 250 and AD 275.

However, the process was more complicated than just a clear transition. There have been earlier inhumation burials from Colchester dating to between AD 150 and AD 175 (*CAR* 9, 264). More recently, excavations at Area C2 of the Colchester Garrison site recorded mid to late 3rd- to 4th-century cremation burials cutting mid 2nd- to mid to late 3rd-century inhumation burials. Also at Area C2, ten 4th-century cremations were found to be interred under barrows. Those interred were possibly Germanic in origin (Garrison Urban Village Areas C and J1, CAT Report 412). At the excavation of the Abbey Field in 2000, in the Garrison, the majority of the cremation burials dated to the mid to late Roman period with some dating to the 4th century (revised CAT Report 138, in prep). Excavations of the eastern cemetery of Roman London produced evidence for inhumation being practised from the late 1st century or early 2nd century alongside cremation. One possible explanation is that they were immigrants from other parts of Britain or the empire with their own inhuming traditions. Another possible explanation is that inhumation was cheaper

(Barber & Bowsher 2000, 19, 300). Data from excavations from Atlantic House, the site of which is in the western cemetery of Roman London, shows that both rites were practised throughout the 2nd and 3rd centuries and there was no evidence to support the accepted theory of cremation burial being the dominant rite through the 1st-early 3rd century, with inhumation becoming more prevalent in the 3rd and 4th centuries. This tends to support the view that the distinction between the two rites was more a matter of fashion and tradition than religious belief (Watson 2003, 38).

Colchester, being a large urban and military centre and, at one time, the capital of the Roman province, would have been one of the first places to adopt new customs and would have been home to different ethnic groups. It should not be unexpected, therefore, to observe a variety of burial rites.

8.5 The layout of the burials

The Handford House site is situated just south of the line of the Roman road leading to London and is within a dense area of Roman burials to the west of the modern and Roman walled town of Colchester (Hull 1958). If these burial plots form part of a large urban cemetery, one would expect it to have been laid out with some planning and to feature evenly-spaced family grave plots and grave markers. The main grouping consisted of the inhumations, which were all in the northern/north-eastern part of the site; however, there were cremation burials occupying this area as well. The cremation burials were spread all over the site but thinned out slightly to the west. This is to be expected as burials become less and less dense the further west of the town one moves.

The piecemeal nature of the excavation and the large areas of disturbance make it difficult to state with any certainty the spacing between the cremation burials. Several were less than a metre apart from each other, while others appeared to be more widely spaced. Approximately 10% of the 68 m x 65 m site was excavated and 68 burials were exposed. Therefore, by the law of averages, the site should originally have contained approximately 680 burials. If we assume that the cemetery was planned rather than developing ad hoc, this works out at one burial every 2.5 m, or 16 burials in a 10 m x 10 m area. This is the minimum estimate as it does not take account of the burials which had already been destroyed by modern activity and therefore left no trace.

Very few of the graves intercut each other, which suggests that graves or plots were marked in some way and were respected. The only intercutting features were two of the inhumation burials (F1 and F154), which possibly cut through cremation burials. A series of six stake holes cutting into one of the cremation burials may have held stakes which marked the burial, as has been found at the eastern cemetery of Roman London (Barber & Bowsher 2000, 109). No other evidence for markers was found, but this may be because markers such as stones, pots, wooden posts or mounds have not survived. One would expect graves to be marked, as we are told by Classical sources that families often returned to graves to commemorate their dead (Toynbee 1971, 51). Perhaps intercutting of burials in the later Roman period would have been greater had there been more pressure on space. Excavations to the south of the town and just outside the town wall to the west have shown that land here was given over for burials in the 3rd or 4th centuries, ie the cemeteries at Butt Road and the St Mary's hospital site (CAR 9; CAT Report 484 forthcoming).

Family groupings and relationships are suggested by the double cremation burials (those with the remains of two individuals in one urn; Barber & Bowsher 2000, 109), and also by a cluster of four cremation burials in the eastern part of the site which were of the same date, contained similar grave goods, and were cremated in a similar way (F42, F44, F53, F142; see section 7.9). Of these four, two were almost definitely related as they were next to each other and each contained half of the same coin. Two other skeletons had the same thickening of the skull and may have been related (F31 and F154). Apart from that, there were not enough complete inhumation burials to look at family relationships through analysis of the bone.

As mentioned in section 8.1, the two *busta* were not in a separate part of the cemetery but were surrounded by cremation burials. It was common for Roman *busta* to be placed in close proximity to other cremation burials (McKinley, 1997, 66). However, there would have been other, non-*bustum* pyres in use and re-use, yet these were not located during the excavation. This is either because they leave no physical trace (not having under-pyre pits) or because they were located away from the burials, in a separate *ustrinum*.

8.6 Graveside feasting

Classical authors inform us that two major religious festivals in the Roman world were set aside for the commemoration and care of the dead; the Parentalia and Lemuria. On the Parentalia, relatives visited the graves of their kin and partook of a meal at the graveside (Ovid, *Fasti* 2:547; Hopkins 1983, 233; Fitzpatrick 1997, 280). It was also customary for relatives to eat a funeral meal by the graveside on the day of the cremation and to revisit graves on the anniversary of the death and to share a meal with the dead (Walker 1985, 10; Hopkins 1983, 233-4). The evidence of this practice from the excavations at the Handford House site was a rubbish-pit at least 3 m wide which was revealed on the northern side of the site (F193 and F205). The pit contained animal bone, including good-quality meat-bearing bones with much evidence of butchering, indicating a feast. The pit, which was located close to burials, contained a small quantity of Roman pottery including an early 2nd-century sherd.

Butchered uncremated animal bone was also recovered from some of the cremation and inhumation burials. Two burials contained fragments of mammal bone, none of which appeared to be burnt (ie one inhumation in a pit and an urned cremation burial with pyre debris). One inhumation burial produced juvenile equid remains. Both pieces of the equid appear to be part of one juvenile femur, and one piece bore a chop mark on the shaft which suggests that it may have been eaten.

These animal remains suggest feasting; however, there is the possibility that animals were sacrificed and placed within the burial as a ritual offering to a god on behalf of the deceased.

The occasional remains of quernstones and whetstones at the Handford House site might be associated with on-site preparation of food (Fitzpatrick 1997, 233).

The type of pottery found in the pyre debris, for example, the presence of the broken flagon in *bustum* F134 hints at drinking and possibly feasting. Alternatively it may have contained wine which was poured on the pyre, either as a libation or perhaps to extinguish the fire. The practice of quenching the pyre flames with wine is attested in Virgil's *Aeneid* and Homer's *Iliad*. Burnt sherds from grey ware jars were also found within the pyre debris from several cremation burials.

8.7 Social status and identity

The people buried at the Handford House site cemetery do not appear to have been from among the upper echelons of society, but neither were they buried in paupers' graves. Most of the burials consisted of simple cremation urns in the ground. There were no grand monuments, and no burials were enclosed in mausolea or in square pits with wooden shuttering. Some burials were slightly more richly furnished than others; for example, those with boxes, glass flasks and mirrors. These individuals may have come from wealthier families or been of higher status. However, grave goods cannot necessarily be taken as indicators of wealth and status. In terms of ancillary vessels, there were no expensive samian platters and most of the pottery consisted of simple tablewares.

The evidence from the glass vessels and small finds, the iconography on the lamps and coins, and the methods of cremation all indicate that, in its earliest phases, the burial ground was associated with inhabitants of the Roman colony with a wholly Romanised life-style, rather than with the surrounding Romano-British (native) population. The *busta* are often associated with military centres and as such would be expected to have been used in Colchester; however, no military personnel were definitely represented in the burials at the Handford House site.

8.8 Physical appearance, relationships and health

Study of the human bone demonstrates that those interred had a normal range of pathologies and injuries and there was nothing unusual in their stature, mortality rates, or ratios of male to female, although there is a peak of child deaths in the 'small child' category, perhaps as a result of childhood illnesses such as measles. Study of the teeth of the inhumation burials showed that their diet was rich in carbohydrates which was normal for the Roman period, and there was evidence that some effort was made to keep teeth clean. The average stature for males was 5 ft 6 inches.

8.9 Religion and beliefs

It is difficult, some would say impossible, to answer questions of belief purely from archaeological remains. Those buried at the Handford House site probably adhered to differing religious ideologies, as Roman beliefs were extraordinarily varied and there was no single dominant orthodoxy (Hopkins 1983, 226). The pantheon of Graeco-Roman gods was not the only belief system; Eastern religions were practised and there were other influences such as Stoicism, Epicureanism, Judaism and, later, Christianity. Native British beliefs would also have held some sway; for example, we are told by Julius Caesar and by Diodorus in the 1st century BC that the Gauls believed in reincarnation (Black 1986, 228). Roman epigraphs show beliefs about the afterlife ranging from nihilism through a vague sense of the soul's ghostly existence (the Manes) to a concept of an individual's personal survival in a recognisable form (Hopkins 1983, 227).

There is evidence from the Handford House site for beliefs about death and the afterlife, although it is hard to determine which gods were worshipped. The graffito A scratched on the amphora F137 which contained a cremation burial, may be an abbreviation of a god's name beginning with A, eg Mercury Andescociuoucos or it could represent the Celtic word Andumnos, meaning the underworld (section 7.17). The functional grave goods like the beakers and lamps indicate belief in life after death, unless they were symbolic. The lamps lit in the graves, the coins in the mouths of the dead, and the symbolic figures on the coins and lamps all indicate a belief in the afterlife with potential dangers and the need for protection. The lamps and possible remains of food and feasting suggest a belief that the deceased still had a body, unless they too were symbolic. The bone die may represent the idea of the 'game of life'. The broken picture lamps in some cremation burials — if they were deliberately broken - may have depicted apotropaic images and their potency would have been invoked by deliberate breakage at an earlier stage in the burial rite. Alternatively, their inclusion in the burials may represent the provision of a ritually 'killed' lamp for the soul on its journey to the underworld, while the complete lamps, which were both placed in the grave alight, were provision for its departure from this one (see section 7.3).

The dead were believed to partake in the graveside feast (Toynbee 1971, 49-51; Hopkins 1983, 233). Therefore the graveside feasting indicates that the living believed that the soul of the deceased occupied the grave for a certain amount of time before embarking on its journey to the afterlife (Black 1986, 230).

There was no definite evidence of sacrifices or libations made to appease the gods, although the occurrence of this practice cannot be ruled out.

The differences between cremation and inhumation may shed light on Roman beliefs. Cremation was a way of thoroughly disposing of the body, perhaps because of a belief of the deceased person's spirit still being able to revisit the living. The transition to inhumation was perhaps connected with a developing belief in the survival of the body and the resurrection of the dead. Alternatively it may have been a following of Greek fashion, which favoured inhumation in sarcophagi. A functional reason, with inhumation requiring less wood, may also be valid. Christianity was not the deciding factor in this change as it took place before the influence of Christianity in Britain.

8.10 The environment

Although wood probably formed the main component of the pyres, subsidiary fuels almost certainly included gorse, bean 'straw', broom, bracken, dried grasses and grassland herbs. The latter two, which were probably used as kindling, appear to have been pulled up from areas of predominantly dry grassland, although a small number of plants more particular to damp areas do appear to have been incorporated (see section 7.9). The analysis of the pollen from within some of the ancillary vessels in cremation burials suggests open weedy conditions with some birch and oak in the catchment area (see section 7.10).

8.11 The metallised areas/road (Graph 1)

Several trenches in the southern part of the site contained gravel metallising which may represent a continuous feature such as a track or road. The best-preserved and most compacted pieces of metallising (F43 and F121) appear to have been cambered, ie they sloped down to the south. The pottery and tile found would suggest a Roman (2nd-century or later) date. F43 is a slight conundrum; its lowest surface was lower down than the top of the cuts for some cremation burials (see Graph 1). If the feature were contemporary with the cemetery and was constructed to link the burials, one would expect it to have been at a higher level. Horizontal truncation of the surface

by later activity may be one explanation. This may also have created the illusion of a camber. Alternatively, the metalling may have been the lining of a hollow way rather than a road, so the lower surface would have been below the Roman ground-level because it had been hollowed out by use. A similar situation was noted at the Colchester Garrison excavations (Area J1), where a driveway had become hollowed out through use over the centuries and had subsequently been metalled. Some of the cremation burials were therefore above the level of the base of the hollow way (CAT Report 412).

The piecemeal nature of the excavation did not allow a firm conclusion to be drawn of the function of the metalled surface(s). They may not be connected and instead may have served as a series of metalled areas, perhaps for sacrificing animals or cooking graveside meals. At the Giltspur Street site, within the western cemetery of Roman London, gravel surfaces probably representing paths through the cemetery were observed (Watson 2003, 31-2). A cobbled area was also found at St Stephen's cemetery (4-6 King Harry Lane) in St Albans (Frere 1987, 328).

Laver, in his diary on March 19th 1923, recorded a section of buff clay, on the corner of West Lodge Road and Queens Road. It was running in a south-westerly to north-easterly direction and Laver supposed it to be the Roman road from Bluebottle/Bell Grove to the Balcerne Gate. However, the feature or features at the Handford House site seemed to be aligned roughly east to west, had a metalled surface and were lying on silt and natural sand and gravel, and so are unlikely to represent the same feature. A footpath is shown crossing the site roughly from west to east on the 1848 Monson map. However, it is not likely that this was metalled and it also crosses the site at a point which is too far north to be the same feature.

8.12 The 19th-century excavation trenches (Fig 5, Fig 74)

Throughout the excavation, large areas of modern disturbance were encountered. These appeared to make up two large trenches in the eastern part of the site and one smaller trench on the western side of the site. Originally they were thought to be horticultural, but their locations do not correspond with plant beds marked on the OS 1876 map nor the Gafwell House sale map of 1892. One interpretation, given their depth and location, is that they were archaeological excavation trenches, dug for antiquarian George Joslin. He built and moved into 10 Beverley Road, opposite Handford House, sometime between 1862 and 1866. Joslin excavated in the Beverley Road area in the second half of the 1860s and collected many cremation urns which are now in Colchester and Ipswich Museums. He also discovered the tombstone of the Roman legionary *Facilis*. The piers of the vinery (F150/F153) were seen to cut into the backfilled trenches and the rubble was laid on top. Therefore the excavation trenches pre-date the vinery. The vinery appears on the 1st edition OS map of 1876, so the excavation trenches must have been dug sometime before that date. The finds within the excavation trenches indicate a 19th-century date, which would correspond with Joslin's excavations. It is not clear whether Handford House (Gafwell House) was built by the time that Joslin's trenches were dug, if, indeed, they are attributable to him. The plot was sold in 1859 for Gafwell House/Handford House so it may have been built or was in the process of being built in the 1860s.

Antiquarian interest in the 19th century tended to focus on artefacts and pots. As cremations yielded more of these items and were usually to be found at a shallower depth, inhumations were often overlooked. We know that Joslin directed excavations within a quarter of a mile of his house (CAR 9, 259), but it is not clear whether he directed proper area excavations or merely recorded finds which came up during groundworks. An alternative interpretation for these trenches is gravel quarries, dug before Gafwell House/Handford House was built. However, the trenches are only a maximum of 1m deep and do not have the appearance of pits dug for gravel extraction.

9 Acknowledgements

The Trust would like to thank Vaughan and Blyth (Construction) Ltd for funding the work and for help on site including lifting the amphora, Emma Hogarth from Colchester Museums' conservation lab. for removal of box fittings, John Lay and Francis Nicholls for metal detecting, Nina Crummy for advice on site on small finds, Val Fryer for advice on site on environmental sampling, Sue Anderson for removal of human bone from the pyre, and James Fawn from the Colchester Archaeological Group for historical information.

The fieldwork was supervised by Kate Orr, and the site work was carried out by Sophie Adams, Colin Austin, Laura Gadsby, Don Goodman, Mariusz Gorniak, Ben Holloway, Brian Hurrell, Liam King, Chris Lister, Laura Pooley, Nigel Rayner, David Ross, Pauline Skippins, Emma Spurgeon, Karly Weller, and Nicole Weller. The project was monitored by Martin Winter and Philip Wise from Colchester Museums.

10 Abbreviations and references

Abbreviations

BABAO	British Association for Biological and Osteoarchaeology
BAR	British Archaeological Reports
Cam/CAM	Colchester pottery type series from <i>Camulodunum, first report on the excavations 1930-39</i> , RRCSAL, 14 , (Hawkes & Hull 1947) and <i>Roman Colchester</i> , RRCSAL, 20 , (Hull 1958)
CAR	<i>Colchester Archaeological Report</i>
CBA	Council for British Archaeology
RCHME	Royal Commission for Historic Monuments of England
RIC	<i>Roman imperial coinage</i>
RIB I	1965 <i>The Roman Inscriptions of Britain: inscriptions on stone, I</i> , R G Collingwood and R P Wright, 2nd edition
RIB II.7	1995 <i>The Roman Inscriptions of Britain: graffiti on samian ware, II.7</i> , ed by SS Frere and RSO Tomlin
RIB II.8	1995 <i>The Roman Inscriptions of Britain: graffiti on coarse pottery, II.8</i> , ed by SS Frere and RSO Tomlin
RIC	<i>Roman Imperial Coinage</i>
RRCSAL	Reports of the Research Committee of the the Society of Antiquaries of London
CK	R A G Carson & J P C Kent, 'Part 2: bronze Roman imperial coinage of the Later Empire AD 346-498' in R A G Carson, P V Hill & J P C Kent, <i>Late Roman bronze coinage</i> (London; 1972)
HK	P V Hill & J P C Kent, 'Part 1: the bronze coinage of the House of Constantine AD 324-346' in R A G Carson, P V Hill & J P C Kent, <i>Late Roman bronze coinage</i> 1972
WEA	Workshop of European Anthropologists

References

Note: all CAT Reports, except some DBAs, are available online at <http://cat.essex.ac.uk> in pdf format

Alcock, J P	1980	'Classical religious belief and burial practice in Roman Britain', <i>Archaeology Journal</i> , 137 , 50-85
Alföldi, A	1935	'Állatdíszes kerékvető-fejek Kelta-Római kocsikról', <i>Archeologiai Ertesítő</i> , 48 , 190-216
Bailey, D M	1980	<i>A catalogue of the lamps in the British Museum. Vol 2, Roman lamps made in Italy</i>
Bailey, D M	1988	<i>A catalogue of [the] lamps in the British Museum: Vol 3, Roman provincial lamps</i>
Barber, B, & Bowsher, D	2000	<i>The eastern cemetery of Roman London: excavations 1983-1990</i> , MoLAS, Monograph, 4
Bass, W	1971	<i>Human osteology</i> , Missouri Archaeol Soc, (Columbia)
Bayley, J, & Butcher, S	1985	'The brooches – descriptive catalogue', in Niblett 1985, 116; mf: 3, C3-9
Bel, V	2002	<i>Pratiques funéraires du Haut-Empire dans le Midi de la Gaule: la nécropole gallo-romaine du Valladas à Saint-Paul-Trois Châteaux (Drôme)</i> , Monographies d'Archéologie Méditerranéenne, 11 (Lattes)

- | | | |
|------------------------------------|------|---|
| Bellows, J | 1881 | 'On some bronze and other articles found near Birdlip', <i>Trans Bristol Gloucestershire Archaeol Soc</i> , 5 (1880-1), 137-41 |
| Bémont, C | 2002 | <i>Les lampes de Glanum</i> , Revue Archéologique de Narbonnaise Supplément, 34 (Montpellier) |
| Berger, L | 1960 | <i>Römische Gläser aus Vindonissa</i> , Veröffentlichungen der Gesellschaft pro Vindonissa, 4 (Basel) |
| Bertrand, I | 2003 | <i>Objets de parure et de soin du corps d'époque romaine dans l'Est picton (Deux-Sèvres, Vienne)</i> , Mémoire de l'Association des Publications Chauvinoises, 23 (Chauvigny) |
| Biddle, M | 1967 | 'Two Flavian burials from Grange Road, Winchester', in <i>Antiq J</i> , 47 , 224-50 |
| Black, E W | 1986 | 'Romano-British burial customs and religious beliefs in south-east England', in the <i>Archaeological Journal</i> , 143 , 201-239 |
| Black, E W | 1995 | 'Voussoirs and wall-tiles', in <i>Excavations in the Marlowe car park and surrounding areas</i> , by K Blockley, M Blockley, P Blockley, S S Frere and S Stow, <i>The Archaeology of Canterbury</i> , 5 , 1267-93 |
| Black, E W | 2000 | 'Roman tiles from CO-OP 1998.59', unpublished CAT archive report (revised 2004) |
| Boon, G C | 2000 | 'The coin catalogue', in <i>Late Iron Age and Roman Silchester</i> , by M Fulford & J Timby, <i>Britannia Monograph</i> , 15 , 128-62 |
| Borrill, H | 1981 | 'Casket burials', in Partridge 1981, 304-321 [304-318, 320-21] |
| Bouts, W, & Pot, Tj | 1989 | 'Computerized recording and analysis of excavated human dental remains', in <i>Burial archaeology: current research, methods and developments</i> , ed by C A Roberts, F Lee, & J Bintliff, BAR, British Series, 211 |
| Brodribb, G | 1987 | <i>Roman brick and tile</i> |
| Brothwell, D | 1981 | <i>Digging up bones</i> , London, British Museum |
| Callender, M | 1965 | <i>Roman amphorae</i> |
| Carazzetti, R, & Biaggio Simona, S | 1988 | <i>Vetri Romani del Cantone Ticino</i> (Locarno) |
| CAR 2 | 1983 | <i>Colchester Archaeological Report 2: The Roman small finds from excavations in Colchester 1971-9</i> , by N Crummy |
| CAR 4 | 1987 | <i>Colchester Archaeological Report 4: N Crummy (ed), The coins from excavations in Colchester 1971-9</i> |
| CAR 5 | 1988 | <i>Colchester Archaeological Report 5: N Crummy, The post-Roman small finds from excavations in Colchester 1971-85</i> |
| CAR 6 | 1992 | <i>Colchester Archaeological Report 6: Excavations at Culver Street, the Gilbert School, and miscellaneous sites in Colchester, 1971-85</i> , by P Crummy |
| CAR 7 | 2000 | <i>Colchester Archaeological Report 7: Post-Roman pottery from excavations in Colchester, 1971-85</i> , by John Cotter |
| CAR 8 | 1995 | <i>Colchester Archaeological Report 8: Roman vessel glass from excavations in Colchester, 1971-85</i> , by H E M Cool and J Price |
| CAR 9 | 1993 | <i>Colchester Archaeological Report 9: Excavations of Roman and later cemeteries, churches and monastic sites in Colchester, 1971-88</i> , by N Crummy, P Crummy and C Crossan |
| CAR 10 | 1999 | <i>Colchester Archaeological Report 10: Roman pottery from excavations in Colchester, 1971-86</i> , by R P Symonds and S Wade, ed by P Bidwell and A Croom |
| CAR 11 | 1995 | <i>Colchester Archaeological Report 11: Camulodunum 2</i> , by CFC Hawkes and P Crummy |
| CAT Report 138 | | Archaeological excavations at the Garrison sports pitch, Circular Road North, Colchester, Essex (Abbey Field), February to March 2000, unpublished CAT archive report, by C Crossan, 2001 |
| CAT Report 210 | | <i>An archaeological evaluation at Handford House, 1 Queens Road, Colchester, Essex</i> , unpublished CAT archive report, by Kate Orr, 2002 |
| CAT report 268 | | An archaeological excavation at 29-39 Head Street, Colchester, May-September 2000. CAT project report, by H Brooks |

CAT report 412		Report on archaeological investigations on land at Areas C1, C2, E, J1, O, Q and S1 of the Alienated Land, Colchester Garrison (Phases 1 and 2). CAT project report by L Pooley, P Crummy, D Shimmin, H Brooks, B Holloway, and R Masefield
CAT Report 484	forthcoming	An archaeological excavation and watching brief at the St Mary's Hospital site, Balkerne Hill, Colchester, 2001-2004. CAT project report by Stephen Benfield
Charlesworth, D	1985	'The glass', in Niblett 1985, microfiche 1:A8 nos b and c
CIM	2008a	<i>Guidelines on standards and practices for archaeological fieldwork in the Borough of Colchester (CBC)</i>
CIM	2008b	<i>Guidelines on the preparation and transfer of archaeological archives to Colchester Museums (CBC)</i>
Cochet, A	2000	<i>Le plomb en Gaule romaine</i> , Monographies Instrumentum, 13 (Montagnac)
Collis, J	1978	<i>Winchester excavations vol 2, 1949-1960</i>
Cool, H E M	2002	'An overview of the small finds from Catterick', in Wilson 2002, 41
Cotta, H	1978	<i>Orthopaedics, a brief textbook</i> (Stuttgart)
Crummy, N	2000	'Roman military cart fitting from eastern England', <i>Bulletin Instrumentum</i> , 12 , 19
Crummy, N	2003	'The casket from site 3', in unpublished report for work along a natural gas pipeline from Ickleton in Cambridgeshire to Matching Green near Harlow, section 13, by Network Archaeology, site code CMG01
Crummy, P, Benfield, S, Crummy, N, Rigby, V, and Shimmin, D	2007	<i>Stanway: an élite burial site at Camulodunum</i> , Britannia Monograph Series, 24
Cunningham, C M	1985	'A typology for post-Roman pottery in Essex', in <i>Post-medieval sites and their pottery: Moulsham Street, Chelmsford</i> , by C M Cunningham & P J Drury, Chelmsford Archaeological Trust Report 5 and Council for British Archaeology Research Report 54 , 1-16
Davies, B J, Richardson, B, & Tomber, R S	1994	<i>The archaeology of Roman London, 5: a dated corpus of early Roman pottery from the City of London</i> , CBA, Research Report, 98
Davies, J L	1987	'A bronze vehicle mount from Trawscoed, Dyfed', <i>Britannia</i> , 18 , 277-8
Davis, SJM	1992	<i>A rapid method of recording mammal bones from archaeological sites</i> , English Heritage, AMLReport 19/92
Dean, M, & Hammerson, M	1980	'Three inhumation burials from Southwark', in <i>London Archaeology</i> , 4 , 17-22
Down, A & Rule, M	1971	<i>Chichester excavations 1</i>
EAA 3	1997	<i>Research and archaeology: a framework for the Eastern Counties 1. Resource assessment</i> , East Anglian Archaeology, Occasional Papers, 3 , ed by J Glazebrook
EAA 8	2000	<i>Research and archaeology: a framework for the Eastern Counties 2. Research agenda and strategy</i> , East Anglian Archaeology, Occasional Papers, 8 , ed by N Brown & J Glazebrook
EAA 14	2003	<i>Standards for field archaeology in the East of England</i> , East Anglian Archaeology, Occasional Papers, 14 , ed by D Gurney
ECC	2002a	<i>Fields of fire – the interpretation of funerary remains from Elms Farm, Heybridge</i> , in Essex past and present newspaper, 4
ECC	2002b	<i>Archaeology in the pipeline</i> , in Essex past and present newspaper, 4
ECC	2003	<i>Digging in Dunmow: burials from the first century</i> , in Essex past and present newspaper, 5
Eckardt, H	1999	'The Colchester "child's grave"', <i>Britannia</i> , 30 , 57-80
Eckardt, H	2002a	<i>Illuminating Roman Britain</i> , Monographies Instrumentum, 23 (Montagnac)
Eckardt, H	2002b	'The Colchester lamp factory', <i>Britannia</i> , 33 , 77-93
Egan, G	1998	<i>The medieval household</i> , Medieval finds from excavations in London, 6

- Fitzpatrick, A P (ed) 1997 *Archaeological excavations on the route of the A27 Westhampnett Bypass, West Sussex, 1992*, Wessex Archaeology Report, **12**
- Foster, J 1986 *The Lexden Tumulus - a reappraisal of an Iron Age burial from Colchester, Essex*, BAR British Series **156**
- Frere, S S 1987 'Review of work at St Stephen's cemetery', in *Britannia*, **18**, 329-30
- Funari, PPA 1996 *Dressel 20 inscriptions from Britain and the consumption of Spanish olive oil*, BAR British Series, **250**
- Goethert-Polaschek, K 1977 *Katalog der römischen Gläser des Rheinischen Landesmuseums Trier (Mainz am Rhein)*
- Greene, K 1978 'Flavian "ring and dot" beakers from Londinium: Verulamium form 130 and allied types', in *Early fine wares in Roman Britain*, ed by P Arthur and G Marsh, BAR, British Series, **57**, 109-118
- Guido, M 1978 *The glass beads of the prehistoric and Roman periods in Britain and Ireland*
- Hagen, W 1937 'Kaiserzeitliche Gagatarbeiten aus dem rheinischen Germanien', *Bonner Jahrbücher*, **142**, 77-144 (Bonn)
- Hall, A F 1959 'Roman burn-bake cremation', in *Colchester Archaeological Group Quarterly Bulletin*, **2**, no 2
- Harden, D B, Hellenkemper, H, Painter, K, & Whitehouse, D 1987 *Glass of the Caesars* (Milan)
- Hawkes, C F C, & Dunning, G C 1930 'The Belgae of Gaul and Britain', *Archaeol Journal*, **87**, 150-335
- Hawkes, C F C, & Hull, M R, 1947 *Camulodunum, first report on the excavations at Colchester 1930-39*, RRCSAL, **14**
- Henig, M 1984 *Religion in Roman Britain*
- Henig, M, & Wickenden, N P 1988 'A hoard of jet and shale', in *The mansio and other sites in the south-eastern sector of Caesaromagus*, by P J Drury, Chelmsford Archaeological Trust Report 3.1 and CBA Research Report, **66**, 107-110
- Homer The Iliad (translated by R Lattimore, 1951), Chicago
- Hopkins, K 1983 *Death and renewal*
- Hull, M R 1958 *Roman Colchester*, RRCSAL, **20**
- IFA 1995 *Standard and guidance for archaeological excavation*
- IFA 2001 *Standard and guidance for the collection, documentation, conservation and research of archaeological materials*
- Isings, C 1957 *Roman glass from dated finds* (Groningen Djarkarta)
- Isings, C 1971 *Roman glass in Limburg* (Groningen)
- Janaway, R 1983 *Textile fibre characteristics preserved by metal corrosion: the potential of SEM studies*, *The Conservator*, **7**, 48-52
- Johns, C 1982 *Sex or symbol*
- Johns, C 1996 *The jewellery of Roman Britain, Celtic and classical traditions*
- Johns, C, & Wise, P 2003 'A Roman gold phallic pendant from Braintree, Essex', *Britannia*, **34**, 274-6
- Jones, M J 2002 *Roman Lincoln*
- Károly, G, 1890 'Okori kocsik helyreállításá', *Archeologiai Ertesítő*, **10**, 97-126 (Budapest)
- Krogman, W 1978 *The human skeleton in forensic medicine* (Illinois)
- Laver, P 1923 unpublished diary, (handwritten notes provided by James Fawn)
- Lawson, A J 1976 'Shale and jet objects from Silchester', *Archaeologia*, **105**, 241-75
- Lentowicz, I J 2002 'Copper-alloy objects from Catterick Bypass and Catterick 1972 (Sites 433 and 434)', in *Cataractonium: Roman Catterick and its hinterland. Excavations and research, 1958-1997 II*, by P R Wilson, 46-78
- Lloyd-Morgan, G 1977 'Mirrors in Roman Britain', in *Roman life and art in Britain*, ed by J Munby and M Henig, BAR, **41**, 231-52
- Lloyd-Morgan, G 1980 comment on the mirror from Harper Road in Dean & Hammerson 1980, note 7

- Lloyd-Morgan, G 1981 *Descriptions of the collections in the Rijksmuseum G M Kam at Nijmegen, IX: the mirrors* (Nijmegen)
- Loeschke, S 1919 *Lampen aus Vindonissa* (Zurich)
- Lysons, S 1792 'Account of Roman antiquities discovered in the County of Gloucester', in *Archaeologia*, **10**, 131-6
- MacDonald, J 1977 'Pagan religions and burial practices in Roman Britain', 35-38 in Reece 1977.
- Mackinder, A 2000 *A Romano-British cemetery in Watling Street: excavations at 165 Great Dover Street, Southwark, London*, MoLAS, Archaeology Studies, Series **4**
- Manning, W H 1985 *Catalogue of the Romano-British iron tools, fittings and weapons in the British Museum*
- Marsh, G 1978 'Early second century fine wares in the London area', in *Early fine wares in Roman Britain*, ed by P Arthur and G Marsh, BAR British Series **57**
- May, T 1930 *Catalogue of the Roman pottery in the Colchester and Essex Museum*
- Mays, S A 1998 *The archaeology of human bones*
- McKinley, J I 1994 *The Anglo-Saxon cemetery at Spong Hill, North Elmham part VIII: the cremations*, East Anglian Archaeology, **69**
- McKinley, J I 1997 'The cremated human bone from burial and cremation-related contexts' in Fitzpatrick 1997, 55-73
- McKinley, J I 2000a 'Putting cremated human remains in context', in *Interpreting stratigraphy: site evaluation, recording procedures and stratigraphic analysis*, ed by S Roskams, BAR, International Series, **910**
- McKinley, J I 2000b 'Cremation burials', in *The Eastern cemetery of Roman London. Excavations 1983-1990*, by B Barber & D Bowsher, MoLAS Monograph, **4**, 264-77
- McKinley, J I 2004 'Compiling a skeletal inventory: cremated human bone', in *Guidelines to the standards for recording human remains*, ed by M Brickley & J I McKinley, IFA Paper, **7**, BABAO and IFA
- Meeks, N 1995 'A technical study of Roman bronze mirrors', *Acta of the 12th international congress on ancient bronzes, Nijmegen*, 179-93 (Nijmegen)
- Meid, D 1994 *Gaulish Inscriptions*, Archaeolingua Series Minor, **1** (Budapest)
- Millett, M 1987 'An early Roman burial tradition in central southern England', in *Oxford Journal of Archaeology*, **6**(1), 63-8
- Niblett, BRK 1985 *Sheepen: an early Roman industrial site at Camulodunum*, CBA, Research Report, **57**
- Ortner, D, & Putschar, W 1981 *Identification of pathological conditions in human skeletal remains* (Washington)
- Oswald, F 1936-37 *Index of figure-types on terra sigillata ('samian ware')*, Annals Archaeol Anthropol, **23**. 1-4 and **24**.1-4, Supplement
- Partridge, C 1977 'Excavations and fieldwork at Braughing 1968-73', *Hertfordshire Archaeol*, **5**, 22-108
- Partridge, C 1981 *Skeleton Green. A late Iron Age and Romano-British site*, Britannia Monograph, **2**
- Philpott, R 1991 *Burial practices in Roman Britain: a survey of grave treatment and furnishing AD 43-410*, BAR, British Series, **219**
- Price, J, & Cottam, S 1998 *Romano-British glass vessels: a handbook*, CBA, Practical handbook in archaeology, **14**
- RCHME 1928 (Royal Commission on the Historical Monuments of England), *An inventory of the historical monuments of London, 3: Roman London*
- Reece, R 1977 *Burial in the Roman world*, CBA Research Report **22**.
- Reece, R 2002 *The coinage of Roman Britain*
- Rhodes, M 1980 'Leather footwear', in *Excavations at Billingsgate Buildings, 'Triangle', Lower Thames Street, 1974*, ed by D M Jones, LAMAS Special Paper **4**, 99-128
- Riha, E 2001 *Kästchen, Truhen, Tische - Möbelteile aus Augusta Raurica*, Forschungen in Augst, **31** (Augst)

- Saunders, C 1985 'The burial casket', in Niblett 1985, mf I: A9-13
- Scatozza Höricht, L A 1986 *I vetri Romana di Ercolano*, Ministero per i beni culturali ed ambientali soprintendenza archeologica di Pompei Cataloghi, **1** (Rome)
- Simon-Hiernard, D 2000 *Verre d'epoque Romaine: Collection des Musées de Poitiers* (Poitiers)
- Simonett, C 1941 *Tessiner Gräberfelder*, Monographien zur Ur -und Frühgeschichte der Schweiz, **3** (Basel)
- Stace, C 1997 *New flora of the British Isles*, second edition
- Stead, I M, & Rigby, V 1986 *Baldock: the excavation of a Roman and pre-Roman settlement, 1968-72*, Britannia, Monograph series, **7**
- Stead, I M, & Rigby, V 1989 *Verulamium: the King Harry Lane site*, English Heritage Archaeological Report, **12**
- Stefani, G 2003 *Menander: la casa del menandro di Pompei* (Milan)
- Stirland, A 1989 'The cremations from the Iron Age cemetery', in *Verulamium: the King Harry Lane site*, by I M Stead & V Rigby, English Heritage Archaeol Rep, **12**
- Struck, M 1993 *Römerzeitliche Gräber als Quellen zu Religion, Bevölkerungsstruktur und Socialgeschichte*, Archäologische Schriften des Instituts für Vor- und Frühgeschichte der Johannes Gutenberg-Universität, Mainz, **3**
- Symonds, R P 2003 'Romano-British amphora', in *Journal of Roman pottery studies, vol 10, Amphorae in Britain and the western empire*, ed by J Plouviez & R P Symonds
- Symonds, R P & Wade, S M 1989 'A remarkable jar found inside an amphora cremation chamber at Colchester', in *Journal of Roman Pottery Studies*, **2**, 85
- Toynbee, J M C 1971 *Death and burial in the Roman world*
- Toynbee, J M C 1973 *Animals in Roman life and art*
- Toynbee, J M C, & Wilkins, A 1982 'The Vindolanda horse', *Britannia*, **13**, 245-51
- Trotter, M 1970 'Estimation of stature from intact long limb bones', in *Personal identification in mass disasters*, ed by T D Stewart (Washington)
- von Mercklin, E 1933 'Wagenschmuck aus der römischen Kaiserzeit', *Jahrbuch des Deutschen Archäologischen Instituts*, **48**, 84-176 (Berlin)
- Walker, S 1985 *Memorials to the Roman dead*, British Museum publications
- Watson, S 2003 *An excavation in the western cemetery of Roman London: Atlantic House, City of London*, MoLAS, Archaeology Studies, Series **7**
- WEA 1980 'Recommendations for age and sex diagnoses of skeletons', in *J Human Evolution*, **9**, 517-49
- Webster, G 1958 'The advance under Ostorius Scapula', *Archaeological Journal*, **115**, 49-98
- Wells, C 1981 'Report on three series of Romano-British cremations and four inhumations from Skeleton Green', in *Skeleton Green, a Late Iron Age and Romano-British site*, by C Partridge, Britannia, Monograph Series, **2**, Society for the Promotion of Roman Studies
- Westell, W P 1931 'A Romano-British cemetery at Baldock, Herts', in *Archaeological Journal*, **88**, 247-301
- Wheeler, R E M 1943 *Maiden Castle, Dorset*
- Whiting, W, Hawley, W, & May, T 1931 *Report on the excavation of the Roman cemetery at Ospringe, Kent*, RRCSAL, **11**
- Wild, J P 1970 *Textile manufacture in the northern Roman provinces*
- Wild, J P 2002 *The textile industries of Roman Britain*, Britannia, **33**, 1-42
- Wilson, M G 1968 'Other objects of bronze, iron, silver, lead, bone, and stone', in *Fifth report on the excavations of the Roman fort at Richborough, Kent*, by B Cunliffe, 93-114
- Wilson, PR 2002 *Cataractonium: Roman Cartterick and its hinterland. Excavations and Research 1958-1997. II*

11 Glossary

BAR	British Archaeological Report Series
Bronze Age	the period following the Stone Age, characterised by the use of bronze, c 2000-800 BC
<i>bustum</i>	site of cremation and burial where the pyre is constructed over a grave-shaped pit. The pyre debris and the cremated remains then form the primary fill of the pit
CBA	Council for British Archaeology
context	specific location on an archaeological site, especially one where finds are made
CBM	Ceramic Building Material
ECC	Essex County Council
EHHER	Essex Historic Environment Record, Essex County Council
ERO	Essex Record Office
feature	an identifiable thing like a pit, a wall, a drain, a floor; can contain 'contexts'
Iron Age	the period following the Bronze Age and preceding the Roman invasion, c 800/700 BC-AD 43
medieval	the period from 1066 to c AD 1500
modern	the period from c 1800 to the present day
NGR	National Grid Reference
natural	geological deposit undisturbed by human activity
Neolithic	the new Stone Age, in Britain the period from c 4000 to 2000 BC
OD	height above sea level
post-medieval	the period from AD c 1500 to c 1800
Roman	the period when Britain was a province of the Roman Empire from AD 43 to c AD 430
Tertiary	a flint flake that does not have any cortex remaining, ie from the interior of the flint
U/S	unstratified find, ie without a context

12 Archive deposition

The archive is held by the Colchester Archaeological Trust at 12 Lexden Road, Colchester, Essex CO3 3NF, but it will be permanently deposited with Colchester Museums under accession code 2003.5.

© Colchester Archaeological Trust 2006 and 2021

Distribution list:

Vaughan and Blyth (Construction) Ltd
Martin Winter, Archaeology Officer for Colchester Borough Council
Essex Historic Environment Record, Essex County Council



Colchester Archaeological Trust
12 Lexden Road,
Colchester,
Essex CO3 3NF

tel.: (01206) 541051
tel./fax: (01206) 500124
email: archaeologists@catuk.org

Checked by: Philip Crummy
Date: 10.01.06

Appendix 1: Roman pottery catalogue and groups by Stephen Benfield

Table 26: catalogue of Roman pottery, with dates.

Context no	Findings no	Trench	Context Description	Fabric and Form	Date of context
F001	1	2	inhumation	sq white ware beaker or flagon DJ	Roman
F001	3	2	Inhumation	2x DJ	Roman
F001	29	2	inhumation	1x Early Roman; 2 x burnt samian (Drag 15/17); 2 x flagon sherds; 1 x greyware; 1 x ?R	Roman
F001	31	2	inhumation	sq GX	Roman
F004	11	2	drain trench	1xGX	Modern
F004	14	2	drain trench	sq DJ flagon sherds and GX greyware	modern
F005	18	4	ditch	sq GX (CAM 268)	Roman?
F006	20	4	shallow ditch	2x GX (rim?) (CAM 268)	Roman?
F008	25	7	large pit	1x GB/KX very abraded bead rim bowl? (CAM 37); 1x GX rim (CAM? 280-281)	?
F008	60	7	large pit	5x GX all (?CAM 266); 1x AA amphora	modern
F008	96	7	large pit	frags of greyware GX jar & 1 flagon sherd	modern
F009	26	5	shallow ditch	2x GX; 1x AA amphora	modern
F011	33	3	19th C excav trench	1 x DJ	modern
F011	33	3	19th C excav trench	2 x greyware	modern
F011	33	3	19th C ex trench	1 x GX	modern
F012	47	4	excavation trench	sq GX; 1x GB (CAM 39); 1x HZ; 1x DJ; 1x Lid frag ?fabric	modern
F013	73	8	19th C excav trench	1 x D20 amphora DJ	modern
F014	42	9	shallow ditch	1 x greyware	modern
F015	47	11	urned cremation	1 urn (CAM 270b)	1-3C
F015	50	11	urned cremation	1x DJ	1-3C
F015	1115	11	urned cremation	sq of DJ lid (CAR 10 Type 163)	1-3C
F015	1123	11	urned cremation	DJ half of lid (CAR 10 DJ type 163)	1-3C
F017	50	12	shallow trench	1 x AA?	post-med or modern
F018	54		pipe through F19	cc Lyon ware cup frags; flagons frags; frags of Tazza burner; gw & buff sherds	modern
F018	69	11	gas pipe through F019	Tazza incense burner frags; flagon sherds	modern
F018	69	11	pipe thro' F19	6x DJ; 1x GX	modern
F019	67	11	disturbed cremation	rim of Tazza incense burner; flagon sherds; Lyon Ware	1-2 C
F019	68	15	urned disturb crem	quantity DJ frags probably flagon and small jar	1 -2C
F028	76	4	large ditch	4x DJ	post med or modern
F030	78	9	large ditch	2x GX; 1x ?UR (LTC) (CAM 16/30)	modern
F031	84	8	inhumation	1x GX; 1x WA; 1x GA (CAM 279); 1x GB (CAM 40B)	E2-M-L3C+
F032	99	9/15	large pit or ditch	sq flagon; 1 x TM mortarium; 1 x AJ amphora; 3 x greyware inc CAM 268)	modern
F034	86	13	pit	ring necked flagon sherds	modern
F034	91	13	Pit	sq DJ; 1 x samian (DR 27) (slightly burnt) 1x UR/GR	modern
F035	89	13	excavation trench	sq Roman pottery	modern

Context no	Findings no	Trench	Context Description	Fabric and Form	Date of context
F036	93	2	urned? disturb crem	1 x burnt samian (Drag 15/17) + sherds of ring necked flagon (CAM 154)	?1-2C
F036	94	13	disturbed cremation	sq DJ	1-2C?
F038	105	7	19th C excav trench	vsq Roman pot	Modern
F038	126	7	excavation trench	1x Greyware GX	modern
F039	105	8	pit thro' inhum F31	sq GA (CAM 279); GB (CAM 39/40); EA Nene Valley Colour Coat; CZ	post-med
F039	107	8	pit thro' inhum F31	1x Samian - BA (Drag 45); 1x TE Nene Valley mortarium 1x KX (CAM 37/38)	post med or modern
F039	107	8	pit thro' inhum F31	1x (CAM 279); 3x (CAM 268); 1x CH; 1x (CAM 281/282); sq GX	post med or modern
F039	107	8	pit thro' inhum F31	1x HZ sherd	post med or modern
F039	119	8	pit thro' inhum F31	frags of GA pot (CAM 279)	post med?
F039	121	8	pit thro' inhum F31	2 frags of UR Terra Nigra platter & 2x Black Burnished ware GA (CAM 279c)	post med
F040	118	7/8	inhumation	1x GX	Roman
F040	118	7/8	inhumation	1xGX	Roman
F041	128	Sk2	urned disturb crem	quantity of a white ware DJ ring-necked flagon. rim missing but mostly there; 1 x greyware	1-2/3C
F041	129	Sk2	road/stone surface	2x DJ,	1 -2/3C
F041	139	Sk 2	urned disturb crem	flagon frags	1-2/3C
F041	140	Sk2	sq DJ		1 -2/3C
F042	136	Sk1	urned cremation	GX jar (CAM 266)	1-2C
F042	137	Sk1	urned cremation	Flagon (CAM 154/155) ring-necked fabric DJ	1 -2C
F042	138	Sk1	urned cremation	Frag of whiteware flagon locally made	1-2C
F042	148	Sk1	urned cremation	GX base of (CAM 108)	1-2C
F042	151	Sk1	urned cremation	sq of DJ + DX?	1-2C
F042	152	Sk1	urned cremation	3x DJ	1-2C
F042	153	Sk1	urned cremation	small version of a (CAM 266/221)	1-2C
F043	149	no	road	1x AJ sherd D20 oil amphora; 1x AA rim sherd(CAM 186) salzon amphora; 1x samian (Drag 45) (late 2 to 1/2 3rd	Roman
F044	179	14	urned cremation	buff flagon	1-2C
F044	179	14	urned disturb crem;	sq DJ sherds flagon? All same vessel as may be partly heat discoloured. Base and body sherds	1-2C
F044	181	14	urned cremation	sq sherds of ring-necked flagon (CAM 154/155)	1-2 C
F044	182	14	urned cremation	GX jar/bowl (CAM 218)	1-2C
F044	1127	14	urned cremation	1x Whiteware flagon sherd	1-2C
F045	164	17	urned disturb crem	flagon sherds	1/2C
F045	165	17	urned disturb crem	3 sherds of a dish (CAM 8)	1/2 C
F045	170	17	disturbed urned cremation	1 x Roman	1/2 C
F046	185	14	19th C exc trench	sq Roman pottery CZ	modern
F047	204	15	bustum	1 x BB2?	early Roman?
F047	204	15	bustum	Samian Bowl frag with bead rim (early

Context no	Finds no	Trench	Context Description	Fabric and Form	Date of context
				Drag 31 or 31 R) (later 2nd- early 3rd C)	Roman?
F047	204	15	Bustum	sq GX, some may be heated/burnt	early Roman?
F053	197	Sk1	urned cremation	Brockley Hill (CAM 140) flagon: Same Vessel	1-E2C
F053	198	Sk1	urned cremation	Brockley Hill (CAM 140) flagon: Same Vessel	1-E2C
F053	199	Sk1	urned cremation	GX jar (CAM 266), pierced base	1-E2C
F053	200	Sk1	urned cremation	Brockley Hill (CAM 140) flagon: Same Vessel	1 -E2C
F053	208	Sk1	urned cremation	2x DJ	1-E2C
F053	211	Sk1	urned cremation	Brockley Hill (CAM 140) flagon: Same Vessel	1-E2C
F053	214	Sk1	urned cremation	sq DJ + GX. GX looks burnt; 1x DZ? butt beaker	1-E2C
F053	215	1	urned cremation	4 frags (CAM 108) beaker	1 -E2C
F053	224	Sk1	urned cremation	sq DJ	1-E2C
F053	240	Sk1	urned cremation	1 platter with stamp; Terra Nigra type (CAM 16)	1 -E2C
F053	261	Sk 1	urned cremation	burnt greyware sherd	Roman
F053	267	Sk1	urned cremation	sq GX burnt and very burnt sherds	1 -E2C
F053	276	Sk3	urned cremation	3 frags very burnt pot, almost melted - same pot GX (CAM 266); 1x GX less burnt	1-E2C
F053	280	Sk1	urned cremation	2 x burnt ring-necked flagon (CAM 154); burnt sherds (CAM 108); burnt jar sherds (CAM 266) plus 1-2 other sherds	1-E2C
F053	1104	Sk1	urned cremation	1x piece of flagon (lid?) Brockley Hill. Could be part of other bits outside	1-E2C
F053	1107	Sk1	urned cremation	1x Brockley hill; 1x DJ flagon base	1-E2C
F053	1108	Sk1	urned cremation	FJ? flagon sherd (from urn 199)	1-E2C
F053	1109	Sk1	urned cremation	1x Brockley Hill flagon (see 1104)	1-E2C
F053	1122	Sk1	urned cremation	1x GX burnt; 2x GX sherds from small jar base	1-E2C
F054	210	15	pit?	GB rim (CAM 37/ 37b)	Roman
F055	237	19	excavation trench	1x GX	modern
F058	235	20	Ditch	1x GX; 1x HZ; 1x DJ	modern
F059	287	23	disturbed urned cremation	greyware crem urn & lid; other sherds	1-2 C
F059	288	23	disturb urned crem	frags of lower part of DJ flagon	1-2 C
F060	291	25	urned, disturb crem	frags of plain beaker (CAM 108) + partially complete GX vessel	1 -E2C
F062	303	14	excavation trench	1x HZ; 1x GA; 1x GX	modern
F063	301	16	excavation trench?	sq Roman pottery inc amphora	19thC?
F064	302	16	excavation trench	1xHZ	modern
F068	312	32	ditch	1 x (CAM 155) flagon & 1 other flagon sherd	modern
F068	384	32	ditch	1x GX	?
F070	315	30	ditch	vsq greyware	Roman
F072	334	35	excavation trench	1x KX (CAM 278). The rest is GX	modern
F074	364	27	ditch	5 x greyware	Roman?
F075	329	35	pit	1x GX	?
F077	331	31	excavation trench	Modern pipe. Also small quantity DJ; AJ; GX	modern
F080	355	34	ditch	sq of DJ	post med

Context no	Finds no	Trench	Context Description	Fabric and Form	Date of context or modern
F083	345	30	cremation burial	vsq of small fragments including greyware, Fabrics GX and oxidised coarse ware, Fabric DJ	Roman
F085	341	27	disturb unurn? Crem	small quantity greyware inc: GX (inc. CAM 218)	1 -E2C
F087	419	35	disturb urned crem	2x DJ	E2-M3C
F087	431	35	disturb urned crem	most of a GB jar (CAM 278) black burnished ware; 1x Tazza (CAM 198)	E2-M3C
F088	36	66	19th C ex trench	Hadham fabric CH; rim of Nene valley mortaria TE (CAM 500); EA	modern
F088	380	37	disturb urned crem	quantity of sherds. AJ amphora, Dressel 2-4'? (or CAM 186)	1 -E2C
F088	381	37	disturb urned crem	3 x AA amphora; 4x DJ	1-E2C
F088	382	37	disturb urned crem	frags of white flagon; amphora body sherds; sherds of cooking pot GA (CAM 279c), plus grey ware pottery	1 -E2C
F089	347	48	ditch	1 GX (CAM 104?). small quantity of DJ flagon	Roman?
F091	357	a few	excavation trench	1 x DJ; small quantity GX	modern
F091	358	a few	excavation trench	small quantity inc: GX; DJ	modern
F091	386	a few	excavation trench	3x GX	modern
F091	386	a few	excavation trench	3x GX	modern
F093	361	36	disturb urned crem	frags of large GX globular jar and 2 frags of MQ white coated ware	Roman
F093	370	36	disturb urned crem	Most sherds are part of same GX jar (CAM 280)	M-L2-E4C
F094	365	50	large ditch	2x AJ amphora; 1x HZ ; 1x DJ; 2x GX	Roman
F095	366	50	Ditch/gully	1x GX	Roman
F096	388	27	ditch or pit	2xGX	modern
F098	389	49	ditch/large pit	quantity of Roman pot inc: AA; DJ; GX	Roman?
F098	389	49	ditch/large pit	1x HZ sherd	Roman?
F099	401	37/38	gully	1x GA slightly burnt (CAM 279?); 1x GX	?
F100	413	56	pit	1x EA; 2x GX; 1x DJ	?
F101	408	38	disturb urned? crem	vsq DJ and GX	1-2C
F101	409	38	disturb urned? Crem	vsq GX sherds	1-2C
F102	430	43	urned cremation	frags of KX; 2 bead rimmed jar (CAM 328)	E2-L3
F102	430	43	urned cremation	GB base of jar (CAM 278)	E2-L3
F103	458	38	urned cremation	GX (CAM 268) complete cooking pot used as urn	E/M2-L3/E4C
F103	488	38	urned cremation	GX (CAM 266)	E/M2-L3/E4C
F104	417	37	pit,? disturb crem	GB rim (CAM 278); part of small DJ flagon (CAR 10 fig 6.19, no 497)	E-M2-M-L3C
F105	414	38	pit	sq of DJ; GX; 1x UR (E) eggshell ware rim	post med
F106	420	47	large pit or ditch	1x MR (?CAM 316)	modern
F106	547	47	large pit or ditch	2xGX	modern
F107	427	38	disturb urned? crem	vsq (CAM 218) & flagon sherds	1-E2C
F108	487	38	unurned	GB bead rimmed (CAM 328)	E2-L2/E3C

Context no	Findings no	Trench	Context Description	Fabric and Form	Date of context
			cremation		
F108	562	38	un-urned cremation	DJ miniature flask or flagon with pear shaped body, no rim	E2-L2/E3C
F108	584	38	un-urned cremation	1x GX	E2-L2/E3C
F110	464	50	large pit	1x nene valley; 1x cologne EA; sq GX	PM?
F110	640	50	large pit	2x DJ	?
F110	641	50	large pit	1xGX	
F110	643	50	large pit	sq DJ	
F111	451	47	pit	1x DJ; 2x GX	?
F113	540	55	disturb urned crem	Nearly Complete GA (CAM 2790) Cooking/Storage jar/urn, Black Burnished Ware	M-L3-4C
F114	542	45	disturb urned crem	large narrow necked flask, used as urn, fabric GX	1-3C
F114	543	45	disturb urned crem	quantity of GX (CAM 266)	1-3C
F114	1143	45	disturb urned crem	1x DJ/DZ; 1x GX	1-3C
F114	1143	45	disturb urned crem	3x greyware	1-3C
F114	1143	45	disturb urned crem	2x GX greyware	1-3C
F114	1143	45	disturb urned crem	inside urn 532, vsq of (?CAM 108) beaker	1-3C
F114	1150	45	disturb urned crem	large GX flask (CAM 231/232)same flask as 542	1-3C
F115	498	26	urned cremation	GX CAM 256) ovoid cooking pot with everted rim, used as urn. Crack from misfiring, may be a second or waster	LIA-E Roman
F116	638	53	ditch or gravel pit	1 x amph AA; 2 x mortaria TZ; 2 x buff pink whiteware DJ; 1 x GX ; 1 x BB2?	?
F118	685	56	disturb urned crem	1 x greyware; 2 x gritty greyware plus sherds of greyware jar	E2C+?
F120	551	14	casket cremation	frags of rim (CAM 104/266),	1-E2C
F120	551	14	casket cremation	GX (CAM 218)	1 -E2C
F120	551	14	casket cremation	4x GX rim (same pot)	1-E2C
F122	546	46	pit or ditch	sq GX	1-E2C
F122	546	46	pit or ditch	1x EA nene valley colour coat (CAR 10)	3/?4
F123	604	54	un-urn crem/pyre deb	sq white flagon DJ, maybe more than 1	1-3C
F123	604	54	unurned crem/pyre debris	sq DJ	1-3C
F123	636	54	un-urn crem/pyre deb	sq DJ	1-3C
F123	545	54/55	urned'? disturb crem	1x GX	Roman
F125	564	21	pit	1 sherd (CAM 316); 1 CZ sherd (CAM 407); 2 x EA Nene Valley; 1 x HZ sherd plus grey ware	Roman?
F125	674	21	pit	quantity of GX; 1x DJ; 2x CZ (CAM 392)	Roman?
F128	671	39	disturb urned crem	soft sandy red DJ large jar. Very broken up, no rim, lower part of jar only	?1-2/3C
F128	1132	39	disturb urned	everted rim of a small beaker/jar	?1-2/3C

Context no	Findings no	Trench	Context Description	Fabric and Form	Date of context
			crem		
F128	1141	39	disturb urned crem	DJ lid sherds (CAR 10 DJ type 163) (same as find no 1153)	?1-2/3C
F128	1153	39	disturb urned crem	3x DJ lid sherds (CAR 10 type 163) (same as F15 T117?)	?1-2/3C
F129	629	37	disturb urned crem	q sherds of cooking pot/jar (CAM268)	E2-E4C
F129	630	37	disturb urned crem	2x GX	E2-E4C
F130	657	54	pyre debris?	1x GX? rim; 1x DJ	?1-2C
F134	679	50	bustum,	very broken ring-necked flagon (CAM 154/155) - large Claudio Neronian, maybe not burnt	1-2/3C
F134	813	50	bustum	4x DJ flagon; 1x fired clay,	1-2/3C
F134	813	50	bustum	2x GX; sq DJ	1-2/3C
F134	813	50	Bustum	1x DJ	1-2/3C
F134	813	50	urned disturb crem	sq DJ,	1-2/3C
F135	688	34	urned cremation	HD cooking pot used as urn (CAM 259) sooty. 80% there hole in base, part rim missing	?1-2C
F135	688	34	urned cremation	sq GX sherds inside urn, (?CAM 307) lid seated bowl about 50% complete, rim and shoulder only	?1-2C
F135	1142	34	urned cremation	1x DJ	?1-2C
F137	680	45	amphora cremation	2x GX	E-M2C
F137	708	45/46	amphora cremation	AJ amphora D20 (has a stamp)	E-M2C
F137	1083	45	amphora cremation	complete black burnished 2 dish, fabric GB (CAM 40a)	E-M2C
F137	1084	45/46	amphora cremation	KX (CAM 278) jar	E-M2C
F137	1085	45	amphora cremation	complete DJ ring-necked flagon (CAM 156)	E-M2C
F137	1086	45	amphora cremation	complete CZ beaker, colchester colour coat (CAM 391)	E-M2C
F137	1087	45/46	amphora cremation	1 sherd (CAM 110)	E-M2C
F137	1088	45/6	amphora cremation	1x GX	E-M2C
F137	1089	45/46	amphora cremation	1x GX greyware	E-M2C
F137	1090	45/6	amphora cremation	1x greyware	E-M2C
F137	1094	45/6	amphora cremation	Fabric KX rim (CAM 278) jar	E-M2C
F141	981	94	urned cremation	GX (CAM 270b) complete with possible firing spall, storage jar, used as urn	1-2/3C
F141	1003	94	urned cremation	sq DJ; sq GX; 1x FJ	1-2/3C
F141	1111	94	urned cremation	2x whiteware flagon?	1-2/3C
F141	1112	94	urned cremation	same vessel as 1113	1-2/3C
F141	1113	94	urned cremation	sq of butt beaker ?DZ (CAM 112/113) + sq of whiteware. DJ small coarseware jar or beaker	1-2/3C
F141	1114	94	urned cremation	DJ lid (CAR 10 Type 163)	1-2/3C
F142	723	58	urned cremation	GX frags (CAM 266 jar) oxidised/heated, burnt or waster	1-3C
F142	725	58	urned cremation	1x GX greyware	1-3C
F142	725	58	urned cremation	GX jar (CAM 266)	1-3C
F142	796	58	urned cremation	2x GX	1-3C

Context no	Finds no	Trench	Context Description	Fabric and Form	Date of context
F142	1137	58	urned cremation	GX Lid whole but broken (not pot base) (CAR 10 GX type 239)	1 -3C
F144	704	58	ditch or pit	1x TE rim of Nene Valley mortarium (CAM 504/505); GX inc CAM 268	post med or modern
F146	706	56b/57	pit	small quantity inc: DJ; GX	?
F150	889	59	greenhouse hardcore	vsq Roman greyware	modern
F150	890	59	greenhouse hardcore	1 x AJ amphora sherd	modern
F151	794	60	19th C ex pit	2 x amphora sherds AA + AJ; 1 x DJ whiteware 2x GX; 1x BA samian (Drag 31 R)	modern
F151	1192	60	19th C ex pit	2x DJ sherds; sq GX 2 rims (1 jar, 1 bowl)	modern
F151	1192	120	19th C ex pit	1x BA sherd; 1x GX rim bowl/jar	modern
F152	972	56	small ditch	sq DJ, note faint signs of burning cracks and crazing; sq GX	post med or modern
F154	792	61	inhumation	vsq greyware GX (CAM 104)	1-E2C
F154	842	61	inhumation	small quantity of a jar (CAM 104, Possibly CAM 266)	1 -E2C
F155	790	61	excavation trench	sq GX (small jar/bowl) more than one pot	modern
F156	843	56	pit?	1x HZ; 1x AA amphora	1/E2-E3C?
F159	858	63	inhumation	1x DJ whiteware frag; 1x EA nene valley	M3-4C
F162	855	63	urned crem	sq DJ sherds, 1 x pot, flagon? found at the base of the cut, near flagon	E2-E3C
F162	862	63	urned crem	DJ flagon (CAM 256)	E2-E3C
F162	863	63	urned crem	GX greyware frags lid (CAR 10 type 243)	E2-E3C
F162	863	63	urned crem	GX lid for 864. broken. Sand tempered (CAR 10 type 242)	E2-E3C
F162	864	63	urned crem	GX everted rim from a jar/beaker	E2-E3C
F162	864	63	urned crem	double cordoned jar or beaker used as urn. Rim removed in antiquity (CAM 103? variant)	E2-E3C
F162	865	63	urned crem	CB beaker (CAM 391)	E2-E3C
F163	853	62	pit	vsq 2 sherds of Roman pot	2ndC +?
F165	859	68	urned crem	quantity of urn (CAM 123?)	E2-L3/4C
F165	859	68	urned crem	GP? misc. beaker or jar with firing spalls, a second? everted rim	E2-L3/4C
F165	871	68	urned crem	GX (CAM 268), misfired - oxidised	E2-L3/4C
F165	903	68	urned crem	GB bowl (CAM 37a)	E2-L3/4C
F165	946	68	urned crem	small quantity of GX; 2x DJ flagon,	E2-L3/4C
F165	1149	68	urned crem	GX or GB 2 joining sherds (CAM 37a/ 38) burnt?	E2-L3/4C
F166	905	73	large gravel pit	1x GX sherd	
F173	898	71	linear cut	1x GX; 1x DJ	post med
F174	901	75	linear feature	1x DJ	?
F176	924	72	Much of GX jar/bowl	with cordon (CAM 266/CAM 104)no rim; 2x GX sherds inc.1x UR LTC platter rim frag (CAM 14/28)	1/2-3C
F176	925	72	disturbed cremation	1x EA; 1x DJ	1/2-3C
F177	916	59	irregular feature	1x GB rim (CAM 37 ?37b); 1x GX	modern?
F178	920	76	disturb urned crem	quantity of GX (CAM 218) bowl/jar; 1x ?flagon	1-2/3C
F178	920	76	disturb urned crem	GX (CAM 218) most of vessel, some of rim missing, used as urn	1 -2/3C
F178	921	76	disturb urned crem	flagon body sherds	1-2/3 C
F179	935	79	disturb urned crem	Flask (CAM 280/281)	M-L2-4C
F179	936	79	disturb urned	most of one GX urn (CAM 268); 1x	M-L2-4C

Context no	Findings no	Trench	Context Description	Fabric and Form	Date of context
			crem	GX rim of a small greyware flask	
F180	930	77/8	urned cremation	quantity of GX cremation bowl (CAM 218) not all there. Very broken up	1-E2C
F180	931	77/78	urned cremation	GX sherds	1 -E2C
F180	932	77/78	urned cremation	base of rim of (CAM 120b); sherds of flagon; 1 x beaker (CAM 108)	1-E2C
F180	938	77/78	urned cremation	base of greyware pot - burnt	1-E2C
F180	939	78	urned cremation	1x DJ	1 -E2C
F181	1105	56	urned cremation	quantity of GX ware body sherds	1-2C
F181	1105	56	urned cremation	large greyware jar, no rim; 1x DJ flagon handle	1-2C
F182	970	79	urn crem/pyre deb	2 x greyware; quantity of flagon (CAM 154-5)	1-2C?
F182	972	79	urn crem/pyre deb	sq GX; sq DJ	?1-2C
F182	972	79	urn crem/pyre deb	sq DJ poss slightly burnt; 2x GX	?1-2C
F182	972	79	urn crem/pyre deb	sq DJ; sq GX inc. (CAM 108)	?1-2C
F183	959	91	road/trackway	1GB (CAM 278)	roman
F184	964	81	cremation-disturbed	greyware jar frags GW; frag of one other	1-E2 C?
F186	997	88	urned cremation	1x greyware sherd probably from a different vessel. slightly burnt	1 -E2C?
F186	998	88	urned cremation	GX (CAM 266) jar used as urn. Broken but almost 100%	1 -E2C?
F186	999	88	bustum	sq GX some probably burnt	1 -E2C?
F187	1008	78	ditch	vsq DJ buffware	post med
F188	1010	79	ditch	vsq flange bowl GA (CAM 305)	?
F189	1009	88	shallow scoop	vsq greyware	Post Med
F19	58	15	disturbed cremation	burnt? Tazza frags (CAM 108); flagons sherds; greyware	1 -2C
F192	1033	102	urned cremation	white eggshell ware beaker, wide mouthed, fabric DZ, unusual type	1 -E2C
F192	1034	102	urned cremation	whole GX jar used as urn, misshapen, a 2nd (CAM 266 jar)	1-E2C
F193	1029	99	rubbish pit	sq Roman pot inc. brown colour coat ware MR & 'GA (BB1)	Roman?
F194	1037	103/4	stone surface/track	2x GX sherds	
F194	1055	103/4	stone surface/track	1 x greyware	Roman?
F195	1050	107	urned cremation	GX whole jar (CAM 268)	E2-L3/E4
F195	1051	107	urned cremation	lower part of a greyware jar or bowl used as a lid	E2-L3/E4
F196	1053	102	roadside ditch?	vsq greyware	Roman or Post Med
F197	1060	109	urn crem/pyre deb	sqGX and DJ	Roman
F197	1060	109	urn crem/pyre deb	4x DJ; sq GX	Roman
F197	1067	109	urn crem/pyre deb	2x GX	Roman
F197	1076	109	urn crem/pyre deb	sq GX frags	Roman
F197	1076	109	urn crem/pyre deb	1x GX	Roman
F197	1076	109	urn crem/pyre deb	sq GX; 2 p-rom	Roman
F198	1078	108	urned cremation	GB jar (CAM 268)	E2-M-L3C
F198	1099	108	urned cremation	1x Whiteware flagon?	E2-M-L3C
F199	1062	108	urned cremation	same as 1068? from soil sample of SW corner of feature	1 -E2C
F199	1066	108	urned cremation	GX jar (CAM 266)	1-E2C
F199	1068	108	urned	quantity of large ring-necked flagon	1-E2C

Context no	Finds no	Trench	Context Description	Fabric and Form	Date of context
			cremation	(CAM 154/155)	
F200	1167	114	urned cremation	rim frags from urn 1168	E2-M-L3C
F200	1168	114	urned cremation	Fabric KX - nearly whole jar (CAM 278)	E2-M-L3C
F201	1177	No	urned cremation	urn	E2-M-L3C
F201	1178	No	urned cremation	flagon	E2-M-L3C
F203	1180	no	un-urn crem/pyre deb	fragments of a ring-necked flagon (CAM 154/155); 2 sherds of greyware (one is CAM 266)	1st - early 2nd
F203	1181	no	un-urn crem/pyre deb	vsq sherds from flagon, probably same as 1180	1st - early 2nd
F204	1182	No	disturb urned crem	sherds from other vessels & amphora sherds	early Roman
F204	1183		disturb urned crem	2 sherds of (CAM 266/221) vessel, fabric GX; 5 sherds fabric DJ and 5 sherds Fabric FJ	early Roman
F204	1183	no	disturb urned crem	nearly complete with one handle missing Brockley hill flat-bottomed amphora, (CAR 10 F10, FJ, Type 72-74)	early Roman
F204	1184	no	disturb urned crem	(CAM 100), Fabric DZ, base and side of vessel with barbotine panels and barbotine roundels	early Roman
F205	1186	119	animal bone in pit	1 small piece of Roman pottery	Roman?
F207	1190	67	square-sided pit	1 x samian (Drag 15/17)	Roman?
F208	1191	120	disturb inhumation	nearly complete jar used as urn in fragments, (CAM 268)	roman
F209	1194	125	disturbed cremation	vsq GX, jar base, 5 joining base and body sherds, much of lower part of pot	1-2/3 rd
F209	1197	125	disturbed cremation	sq GX, bowl/beaker found inside 1194, much of lower part remaining; 2x GX prob from jar 1194 above	1-2/3 rd
L001	6	3	topsoil	1x GX; 2x DJ	modern
L001	6	3	topsoil	1x DJ sherd	modern
L001	7	3	topsoil	1 x D20 amphora AJ	modern
L001	131	Sk1	topsoil	1 x DJ	modern
L001	154	14	topsoil	sq Roman pottery	modern
L001	154	14	topsoil	1xAJ amphora sherd	modern
L001	155	15	topsoil	sq Roman pot inc GA (CAM 279)	modern
L001	156		topsoil	sq 1 x KX (CAM 305) & other Roman pot inc sherd of samian	modern
L001	206	19	topsoil	2 x GX	modern
L001	207	19	topsoil	1x GX	modern
L001	220	21	topsoil	3x GX; 1x DJ	modern
L001	221	21	topsoil	vsq DJ pottery	modern
L001	236	20	topsoil	sq lamp fragment; other Roman pot	modern
L001	284		topsoil	1x GX (CAM 268)	modern
L001	284	25	topsoil	1x GX abraded sherd	modern
L001	285	20	topsoil	3x GX	modern
L001	292	20	topsoil	1 greyware jar sherd? ; 1 piece of lid	modern
L001	293	30	topsoil	1 x GX; BB2	modern
L001	294	29	topsoil	sq greyware sherds (?CAM 268)	modern
L001	294	29	topsoil	1x GX bowl/jar rim	modern
L001	295	26	topsoil	sq GX inc a lid; 1 x BB1; 2 x DJ	modern
L001	295	26	topsoil	2 x 'honey pot' (CAM 177)	modern
L001	300	25	topsoil	sq GX	modern
L001	306	20	topsoil	sq GX + DJ	modern
L001	313	28	topsoil	sq GX; DJ & GB (BB2)	modern
L001	332	34	topsoil	vsq greyware; 1 x Terra Nigra type ware- UR	modern
L001	335	40	topsoil	2x KX; sq GB (inc CAM 376 + CAM 39); sq GA+ GX (CAM 268); 1x MQ ?Oxford	Modern

Context no	Findings no	Trench	Context Description	Fabric and Form	Date of context
L001	338	51	topsoil	2x GX; 1x DJ	modern
L001	339	35	topsoil	1x DJ D20 amphora. Small quantity GX (inc CAM 108)	modern
L001	349	48	topsoil	1x DJ; GX; HZ	modern
L001	349	48	topsoil	1x DJ; GX; HZ	modern
L001	349	48	topsoil	1x GX rim jar/bowl	modern
L001	351	35	topsoil	vsq GX sherds probably 2 flagons	modern
L001	352	25	topsoil	very small quantity of DJ flagon	modern
L001	353	35	topsoil	sq GX in topsoil, inc 1 possibly burnt,	modern
L001	353	35	topsoil	sq GX in topsoil, inc 1 possibly burnt,	modern
L001	356	34	topsoil	sq GX	modern
L001	362	27	topsoil	1 x greyware; 1 x DJ handle	Modern
L001	367	50	topsoil	1 x AJ amph; vsq GX	modern
L001	368	34	topsoil	1 x greyware	modern
L001	373	38/37	topsoil	1x DZ sherd	modern
L001	376	37	topsoil	1x EA; sq GX (?same pot)	modern?
L001	391	49	topsoil	small quantity roman inc: HZ; GX; DJ	modern
L001	407	38	Topsoil	1x Samian (Drag 33) 138-192 AD; 1x MP	modern
L001	416	38	topsoil	sherds of white flagon; quantity of broken jar	modern
L001	437	46	topsoil	small quantity GX greyware; small quantity burnt or waster GX sherds	modern
L001	437	46	topsoil	1x AJ amphora body sherd	modern
L001	438	?	topsoil	vsq GX (CAM 108)	
L001	439	50	topsoil	vsq greyware GX and flagon (CAM 155)	modern
L001	439	50	topsoil	quantity of sherds inc. part of 1 DJ ring neck flagon? (CAM 154/155 body & neck, no base, 2 x GX sherds	modern
L001	440	54	topsoil	1 x greyware	modern
L001	450	47	topsoil	vsq greyware sherd	modern
L001	460		topsoil	sq Roman pot	modern
L001	460	53	topsoil	1x GX sherd	modern
L001	563	2	topsoil	1x EA base of nene valley beaker; 1x GA (CAM 124 or small jar); 2x MR base of (CAM 316 bowl), sq GX	Modern
L001	615	37	topsoil	1x DJ sherd	
L001	618	43,	topsoil	1x KX (?CAM 376) mortarium; 1 x TZ (?CAM 497) variant; 2x GX	modern
L001	620	35	topsoil	1x UR (E) Terra Nigra ware	modern
L001	687	56	topsoil	sq roman inc: DJ; GX; CZ	modern
L001	687	56	topsoil	1x DJ sherd	modern
L001	695	57	topsoil	quantity of DJ (CAM 119); quantity of GX burnt (CAM 266), some burnt	modern
L001	714	57	topsoil	1xGX	modern
L001	852	68	topsoil	sq greyware (CAM 37b & CAM 268 jar)	modern
L001	852	68	topsoil	sq Roman pot inc EA	modern
L001	852	68	topsoil	1x GX/HZ storage jar; 1x AA amphora	modern
L001	860	68	urned crem	vsq inc. DJ; GX & AJ	Roman
L001	861	68	topsoil	1x AJ? Dressel 20; 1x CH/MR	modern
L001	885	65	topsoil	1x DJ flagon sherd & 1 x GX sherd	modern
L001	888	67	topsoil	2x GX; 1 x samian (Drag 30 or 37)	modern
L001	902	75	topsoil	2x rims GX (?CAM 268); 1 sherd HZ; 1 UR rim uncertain platter type (CAR 10 fig 5.2 no 52)	modern
L001	904	73	topsoil	sq greyware (CAM 306)	modern
L001	917	76	topsoil	1x GB rim (CAM 37); 1x DJ	modern
L001	927	74	topsoil	1x DJ; 1x EA	modern

Context no	Finds no	Trench	Context Description	Fabric and Form	Date of context
L001	973	76	topsoil	1x (CAM 40b.); 1x GX	modern
L001	976	80	topsoil	sq Roman pot plus 1 x amphora sherd & 1 x greyware sherd	modern
L001	977	90	topsoil	sq GX inc. part of a base of jar	Modern
L001	978	89	topsoil	vsq 2 x very abraded Black Burnished Ware sherds	modern
L001	983	83	topsoil	vsq 1 x AJ amphora (D20); 1 x sherd (CAM 37b?), plus greyware	modern
L001	992	79	topsoil	EA and rim of (CAM 273) jar	modern
L001	993	84	topsoil	sq Roman greyware jar sherds	modern
L001	994	86	topsoil	sq sherds of EA pot	modern
L001	995	92	topsoil	1 x greyware	modern
L001	1006	87	topsoil	vsq greyware	modern
L001	1013	84	topsoil	sq Roman pottery	modern
L001	1015	79	topsoil	Roman pottery	modern
L001	1016	105	topsoil	Roman pottery	modern
L001	1018	85	topsoil	vsq rim sherd (CAM 243/244/246); 1 other Roman	modern
L001	1022	96/97	topsoil	q Roman pottery	modern
L001	1023	96	topsoil	sq Roman pottery	modern
L001	1024	94	topsoil	3 sherds of buff ware	modern
L001	1025	88	topsoil	vsq greyware HZ	modern
L001	1027	102	topsoil	vsq greyware	modern
L001	1028	101	topsoil	1 x GX; 1 xEA	modern
L001	1031	105	topsoil	vsq greyware	modern
L001	1032	106	topsoil	1x DJ abraded sherd	modern
L001	1049	102	topsoil	1x UR LTC (CAM 16/30)	modern
L001	1203	126	topsoil	1x GX sherd	modern
L002	6		topsoil	Hoffheim flagon sherds (CAM 140); 1 Lyon Ware; other flagons	post-med
L002	8	5	topsoil or Roman layer	1 x Samian; 1 x Lyon Ware cup frag; other Roman (CAM 39/40)	post-med
L002	10	3	topsoil	1 x CAM 37a	post-med
L002	12	6	topsoil	2x GX (inc. CAM 281/281)	post-med
L002	21	5	topsoil	1 x burnt samian (Drag 27); greyware	post-med
L002	43	9	topsoil	vsq Roman pot inc CAM 154/155	post med
L002	44	10	topsoil	vsq greyware	post-med
L002	46	4	topsoil	1 x C fabric KX (CAM 37/38); 1 x Hadham ware fabric CH	post-med
L002	49	6	Topsoil	1x DJ	post med
L002	63	9	topsoil	1 x greyware jar base	post med
L002	74	11	topsoil	vsq Roman pottery	post med
L002	85	8	topsoil	1 x BB2 sherd + other Roman sherds	post med
L002	95	13	topsoil	GX; DJ; EA	post med
L002	124	10	topsoil	DJ + AA	post med
L002	186	17	topsoil	1 x GX	post med
L002	186	17	topsoil	1 x GX	post med
L002	217	Sk 1	topsoil	vsq handle of patera	post med
L002	703	56	topsoil	1x GX; 1x ?DJ	post med
L002	707	56	topsoil	small quantity inc: 1 x GA; DJ; GX; AJ amphora; EA	post med
L002	727	56	topsoil	quantity of Roman pot inc:(CAM 273); GA(CAM 305a, BB1); & CH (Hadham ware)	post med
L002	727	56	topsoil	1x sherd	post med
L002	1170	113	topsoil	1 piece Dressel 20, AJ	post med
L002	1193	124	topsoil	vsq GX sherds; 1x DJ sherd	post med
L002	1204	126	topsoil	vsq DJ flagon base	post med
L002	1193	124	topsoil	2x GX sherds; 1x KX base sherds, dish/bowl base	post med
L003	32	2	ploughsoil	1x DJ; 1x ?EC	Roman
L003	926	72	ploughsoil	1x GX; 1x Samian (138-192 AD)	Roman

Context no	Finds no	Trench	Context Description	Fabric and Form	Date of context
L003	1014	94	plough soil	most of a flanged bowl (CAM 312/317); 1 x amphora sherd, + other Roman	Roman
L003	1165	111	ploughsoil	VSQ rim sherds of beaker (?CAM 108)	Roman
L003	1166	112	ploughsoil	1x GX sherd	Roman
L003	1171	113	ploughsoil	frags of D20, AJ (not the same as 1170); vsq DJ; 1x GX; 1x KX	Roman
L003	1172	113	Ploughsoil	quantity of GX (CAM 266) jar; 1x GX (not the same)	Roman
L003	1172	113	ploughsoil	1x GX sherd	Roman
L008	459	46	silt layer	3x DJ	modern
L010	125	8	natural	1x GX	natural
L011	142	Sk3	topsoil	2 x GX	modern
L011	142	Sk3	topsoil	2 x GX	modern
L012	143	Sk3	subsoil	sq Roman pottery inc. TY/NV and CH	Roman
L015	309	33	fill 19th C ex trench	1 x amph AA	modern
L016	418	21	subsoil	GX & DJ sherds	post med
L017	983	83	stony layer	1x GX sherd	post-Roman
L019	304	23	deposit	sq CZ colour coat;BB1 (CAM39a); BB2 (CAM 39b)	post-med
L019	317	40	deposit	1 x DJ; 1 x GX	post med?
L021	337	26	silty layer	fragments of a Roman jar (CAM 268?)	modern
L023	374	37	deposit	3x GX	?
L025	360	37	backfill	4x GX sherds	modern
L028	396	56	subsoil	3 x GX greyware	?
L028	400	56	subsoil	1x GX lid	?
L028	406	51	subsoil	2x GX	?
L036	816	62	excavation trench	sq GX why is a trench a L and nor a F?	modern
L036	816	62	excavation trench	1x HZ sherd	modern
L036	848	63	excavation trench	1x EA?; 1x GX (?CAM 268); 3 rim sherds (CAM 212-217)	modern
L036	899	66	excavation trench	Frag of nene valley Mortaria (CAM 503)	modern
L036	1189	66	excavation trench	1x GX flask (CAM 231-2)	modern
L038	960	82	accumulation	1 x greyware sherd	Roman or post-med
L038	965	81	accumulation	2 x flagon base DJ	Roman or post-med
L038	1001	85	accumulation	1x AJ probably flagon base	Roman or post-med
L038	1011	84	accumulation	sq Roman pot	Roman or Post med
L039	928	77/78	deposit	1x GA rim frag (CAM 304); 1x GX	?
L041	1061	108	silty base of Roman road	2x GX	Roman
us	344	29	unstratified	vsq Roman sherds	

Table 27: types of Roman pottery vessels and date of pottery groups from the cremations burials.

* = pot containing cremated bone

feature	jar	jar/bowl	lid	flagon	beaker	dish	other	pottery dated
F15	1*		1					1st-2nd/3rd
F19							tazza (3) also 1 or 2 sherds from 5 other pots	1st-2nd probably 1st-early 2nd
F36				(sherds)		(sherd)		1st-2nd ?1st
F41				1*				1st-2nd century
F42	1*	1		1 flagon, (also sherds from possible flagon)	1 (base only)			1st century ?Claudio-Neronian
F44		1*		?2 (sherds)				1st -early 2nd century ?Claudio-Neronian
F45				1		1 (3 sherd)		1st-2nd century ?Claudio-Neronian
F53	1* ?2nd represented sherds			1 flagon, (also sherds from second possible flagon)	(sherds)	1		1st -early 2nd century ?Claudio-Neronian
F59	1*			1				1st -2nd
F60	1*				1 (sherds)			1st -early 2nd
F85		?1 (sherds)						1st - early 2nd
F87	1*							early 2nd- mid-late 3rd
F88	1 (sherds)			(few sherds)			amphora (sherds from 2 amphora) cup (sherds)	?1st ?pre-Flavian (also sherds mid-late 4th)
F93	1							mid-late 2nd -4th century
F101/ F10		1 (sherds)			1 (sherd)			1st-early 2nd ?pre-Flavian
F102	1* (also sherds possibly second jar)							early 2nd-mid-late 3rd ? early 2nd- early 3rd
F103	1*							mid 2nd-late 3rd/early 4th
F108	1							early 2nd- late 2nd/ early 3rd
F113	2							mid 3rd-4th
F114		(sherds)			(sherds)		large flask 1*	1st-2nd ?1st-early 2nd
F115	1*							1st-early 2nd
F118	(sherds)							Roman ?mid 2nd+
F120		1						1st-early 2nd

feature	jar	jar/bowl	lid	flagon	beaker	dish	other	pottery dated
F123				(sherds)				1st-2nd
F128	1*		1					1st-2nd ?1st-early 2nd
F129	1*							mid 2nd-late 3rd/early 4th
F135	1*							1st
F137	1*			1	1	1	amphora 1	early-mid 2nd
F141	1*		(sherds)		2 (sherds)			1st-2nd
F142	1*		1					1st-early 2nd
F147	?1*							burial record only, pot not seen
F162	1*		1	1	1			early 2nd-late 2nd/early 3rd
F165	1*			(sherds)	1	1		early 2nd-late 2nd/early 3rd
F176	1			(sherds)		1		1st ?pre-Flavian (1 sherd mid 3rd-4th)
F178		1*		1				1st-early 2nd
F179	1*						flask 1	mid-late 2nd – 4th
F180		1*		(sherds)	1 (sherds from 1 or possibly pots)			1st-early 2nd ?pre-Flavian
F181	1*			(sherd)				1st-2nd
F182	?1 (sherds)			1 (sherds)				1st-mid- late 2nd
F184	1*							Roman ?1st-early 2nd
F186	1*							1st-early 2nd
F192	1*				1			early 2nd
F195	1*		1 (jar base used as lid)					mid 2nd – late 3rd/early 4th
F197	(sherds)			(sherds)				Roman ?1st-2nd
F198	1*							early 2nd-mid-late 3rd
F199	1*			(sherds)				1st-early 2nd
F200	1*							early 2nd-mid-late 3rd
F201	1*			1				early 2nd-late 2nd century
F203	(sherds)			(sherds)				1st-early 2nd century
F204					1		amphora 1	Neronian-Flavian
F209	1*				?(sherds)			1st-2nd/3rd century

Appendix 2: Lists of small finds and bulk metal finds

by Nina Crummy

Table 28: summary catalogue of the coins.

Reference abbreviations are listed in the main bibliography. Roman coin periods are those defined in Reece 2002, 145.

SF	Find	Feature Layer	Context description	Identification	Diam	Wt (g)	Reference	Date	Roman Coin Period
244	177 F42.7	F42	cremation	cut half of an <i>as</i> , fits SF 38 from F53; obv and rev worn with no details of design visible; one side marked by heavy scoring	27	4.35	-	1st centu	-
23	166 F44.4	F44	cremation	Titus, <i>as</i> , rev <i>Spes</i>	28	9.43	<i>RIC</i> (Lyons) 868	79-81	4
82	209 F47.1	F47	pyre/ <i>bustum</i>	<i>as</i> , scorched and illegible	27.5	4.84	-	1st-early century	-
38	277 F53.9	F53 Sx 1	cremation	cut half of an <i>as</i> , fits SF 244 from F42; obv and rev worn with no details of design visible; one side marked by heavy scoring	26.5	4.29	-	1st centu	-
106	804 F134.3	F134	pyre/ <i>bustum</i>	Domitian, <i>as</i> , burnt; rev emperor standing left, probably holding palladium on right hand, legend illegible	27	7.97	as <i>RIC</i> 265	81	4
121	1057 F197.3	F197	cremation	Vespasian, <i>as</i> , rev <i>Securitas August</i>	29	7.23	as <i>RIC</i> (Lyon) 811*	70-1	4
131	1098 F198.2	F198	cremation	Antoninus Pius, <i>sestertius</i> , rev <i>Salus</i>	31	23.69	<i>RIC</i> 1307	140-3	7
127	1080 F199.5	F199	cremation	Vespasian, <i>as</i> , scorched; rev <i>Victory</i> , legend illegible	27	8.95	as <i>RIC</i> (Rome) 571	69-79	4
1	16	F2	N-S ditch	Septimius Severus, <i>denarius</i> , ?scorched; rev <i>Indulgentia Aug in Carth</i>	19	2.97	<i>RIC</i> 335	201-10	10
2	19	F5	N-S ditch	illegible <i>Antoninianus</i>	20	2.36	-	250-70	-
47	348	F89	E-W ditch	Trajan, rev completely smooth	22	6.68	-	98-117	5
54	392	F98	N-S ditch	Vespasian, <i>as</i> , rev <i>Aequitas Augusti</i>	27	10.73	as <i>RIC</i> 600, consulship number illegible	70-3	4
55	397	F98	N-S ditch	Constantius II, rev <i>Gloria Exercitus</i> 2 standards	16	1.73	HK 188	330-5	17
68	463	F110	?gravel pit	Urbs Roma copy, rev wolf and twins	15	1.35	copy as HK 51	330-45	17

SF	Find	Feature Layer	Context description	Identification	Diam	Wt (g)	Reference	Date	Roman Coin Period
50	375	L1 (T38)	topsoil	Postumus(?), <i>antoninianus</i> , rev standing female figure with extended right arm and ?cornucopia in left	20	2.15	-	259-68	12
65	441	L1 (T54)	topsoil	illegible	12	0.77	-	3rd-4th c	-
93	639	L1 (T50/46)	topsoil	Galba, <i>as</i> , rev very worn, possibly Roma seated	24	7.93	?as RIC 97	68-9	3
-	852	L1 (T68)	topsoil	George V, 1d	31	-	-	1936	-
120	1036	L1 (T101)	topsoil	Honorius, rev Victoria Augg	13.5	1.14	as CK 174	395-402	21
115	986	L2 (T83)	top/subsoil	Claudius I, <i>as</i> , rev Constantia	28	9.74	as RIC 140	43-54	2
29	183	L3 (T17)	Roman	Urbs Roma copy, rev wolf and twins	13.5	1.42	copy as HK 51	330-45	17
280	815	L36 (T62)	modern	illegible <i>minimissimus</i> , slightly convex	5	0.06	-	late 4th century?	-
117	1012	L38 (T84)	accumulation, medieval or Roman	Vespasian, <i>as</i> ; rev Providen(t?) SC	27	7.72	as RIC pl 36, 8 (Hall Collection), but head to right	71-2	4
11	103	U/S	unstratified, plot 15 + 16?	House of Valentinian, rev Securitas Reipublicae	16.5	2.35	as CK 82	364-78	19
97	709	U/S	unstratified	House of Constantine, rev Victoriae DD Augg Q NN	16	1.48	copy as HK 137	346-50	17

Table 29: pyre debris/deposits and cremation burial deposits from the small finds and bulk metalwork assemblages.

**X....example present (one X only is given for footwear as the precise number of items represented by hobnails cannot be determined);
?X...probable example present; p...pyre debris/deposit; p?... probable pyre debris/deposit; r...residual; s...secondary burial deposit;**

Burial	Date from grave goods	Hobnails	Coin	Lamp	Aedicula	Jewellery box	Jewellery	Mirror	Spoon	Needle	Die	Household storage box	Iron chain	Copper-alloy, Iron, or Lead debris	Stone tool
F15		Xp												Xp	
F19	AD 44-60/1	Xp		Xs	Xs										
F36	1st century; Flavian	Xp				Xp									
F41		Xp				?Xp									
F42	probably AD 44-	Xp	Xs (1/2)	Xs										Xp	?Xs
F44	AD79-81 (preserved coin)	Xp	Xs												
F45		Xp					X								
F47	1st-early 2nd		Xp											Xp	
F53	probably AD 44-60/1	Xp	Xs (1/2)	Xp? Xs						Xp				Xp	
F85	early 2nd?			Xs										Xp	
F87		?Xp													
F101	1st century					?Xp	Xp?								
F108		?Xp										Xs		Xp	
F114													Xp	Xp	
F115		Xp													
F120	1st century; Flavian					Xs									
F123		?Xp													
F126												Xs			?Xs
F128	very late 1st-early 2nd	?Xp		Xs				Xs							
F134	AD 81 +	Xp						Xs	Xs						
F137	very late 1st			Xs											
F141	late 1st-early 2nd	Xp		Xp? Xs											

Burial	Date from grave goods	Hobnails	Coin	Lamp	Aedicula	Jewellery box	Jewellery	Mirror	Spoon	Needle	Die	Household storage box	Iron chain	Copper-alloy, iron, or Lead debris	Stone tool
F142		Xp												Xp	
F162	1st century	?Xp					Xs Xs Xs (bead, armlet finger-ring)							Xp	
F178		Xp													
F179		Xp?													
F180		Xp													
F182		Xp													
F192		Xp?													
F195														Xp?	
F197	AD 70-1 +	?Xp													
F198	AD 140-3 +		Xs												
F199	last quarter 1st	Xp	Xp	Xp? Xs		X					Xp				
F200								Xs							
F203		Xp													
F209	1st century	Xp					XsXs (bead, armlet)								

Appendix 3: cremated human bone - quantification and measurements

by Sue Anderson

Table 30: quantification and measurements of cremated human bone.

Burial	Find No	Spit	Mesh	Residue Wt/g	Approx bone %	Estimated bone Wt/g	Skull Wt/g	Axial Wt/g	U limb Wt/g	L limb Wt/g	Unident Wt/g	Totals Wt/g	max skull (mm)	max l.b. (mm)	Animal Wt/g
F15	47	1	<5mm	55	5	2.8					2.8	2.8			
		2	5mm+				0.8	0.1				0.9	16	-	
		4	5mm+				1.2			0.2	0.5	1.9	16	-	
		5	<5mm	79	5	4.0					4.0	4.0			
			5mm+				5.2	0.5	4.0	2.7	1.2	13.6	27	38	
		6	<5mm	103	70	72.1					72.1	72.1			
			5mm+				14.9	4.5	9.4	52.8	24.0	105.6	31	53	
		7	<5mm	117	90	105.3					104.8	105.3			
			5mm+				28.9	24.9	37.4	68.7	78.8	238.7	43	53	
		8	<5mm	141	90	126.9					124.8	126.9			
		5mm+				47.7	25.0	36.2	35.4	89.8	234.1	56	64		
	9	<5mm	330	50	165.0					165.0	165.0				
		5mm+				12.1	29.7	10.5	65.4	82.1	199.8	37	37		
			Totals			476.0	113.4	84.7	97.5	225.2	749.9	1270.7			
F18	54						1.5				1.5	1.5	19	-	
	55		<5mm	141	10	14.1					14.1	14.1	35	40	1.2
			5mm+				35.3	11.3	26.7	25.8	53.0	152.1	-	27	
	70							2.3			2.3				
			Totals			14.1	36.8	11.3	29.0	25.8	67.1	170.0			1.2
F19	68						25.4	7.5	10.3	11.1	39.5	93.8	45	43	1.9
			Totals				25.4	7.5	10.3	11.1	39.5	93.8			1.9
<i>Total F18/F19</i>							<i>62.2</i>	<i>18.8</i>	<i>39.3</i>	<i>36.9</i>	<i>106.6</i>	<i>263.8</i>			<i>3.1</i>

Burial	Find No	Spit	Mesh	Residue Wt/g	Approx bone %	Estimated bone Wt/g	Skull Wt/g	Axial Wt/g	U limb Wt/g	L limb Wt/g	Unident Wt/g	Totals Wt/g	max skull (mm)	max l.b. (mm)	Animal Wt/g	
F36	94		<5mm				5.8	2.3	0.6		10.2	18.9	33	-		
			5mm+				2.5	1.0	2.2	2.2	7.1	15	15	28		
			Totals				8.3	3.3	2.8	2.2	17.3	33.9				
F41	128	1	<5mm	39	5	2.0					2.0	2.0				
			5mm+				3.2	0.1		1.7	0.4	5.4	25	16		
			<5mm	32	10	3.2					3.2	3.2				
			5mm+				1.0	0.1		0.3	3.9	5.3	19	27		
			<5mm	86	25	21.5					21.5	21.5				
			5mm+				14.0	2.8	5.3	6.5	6.3	34.9	35	40		
			<5mm	77	25	19.3					18.3	19.3				
			5mm+				16.8	7.8	4.8	4.2	8.5	42.1	28	30		
			<5mm	56	1	0.6					0.6	0.6				
			129								4.3	0.1	1.9	0.7	6.9	13.9
134								2.0	2.3			3.1	7.4	19	-	
140								0.5	0.2	1.4		9.2	11.3	13	17	
			Totals			46.5	42.8	13.4	13.4	13.4	83.8	166.8				
F42	133						0.4	0.8			1.0	2.2	18	-		
							1.3		2.4		1.6	5.3	20	33	4.3	
			3	<5mm	269	5	13.5			0.5		13.0	13.5	-	-	
				5mm+				1.6			1.3	2.9	20	-	-	
			4	<5mm	175	50	87.5					87.5	87.5	-	-	
				5mm+				107.6	3.8	18.6	20.6	49.7	200.3	35	40	
			147								2.2	2.2	-	20		
			150								0.2	0.9	1.1	12	-	
151									0.1	0.1	-	-				
152		<5mm	878	5	43.9				1.4	0.3	1.3	40.9	43.9	14	19	1.3

	153	3	5mm+							0.1	0.1	-	-		
		4	5mm+							0.3	0.3	-	-		
	176		<5mm	187	0	0.0				0	0	-	-		
	177						3.6	0.3		4.5	8.4	17	-	1.2	
	189		<5mm							2.9	2.9	-	-	2.9	
	Totals					144.9	116.1	5.2	22.8	20.6	206.0	370.7		9.7	
F44	178						7.9	0.4			23.2	31.5	23	-	7.1
	182	1	<5mm	19	5	1.0				1.0	1.0				
			5mm+				0.6			0.4	1.0	14	-		
		2	<5mm	16	25	4.0				4.0	4.0				
			5mm+				2.8	0.3			4.3	28	29		
		3	<5mm	32	5	1.6				1.6	1.6				
			5mm+				5.4	0.3		0.3	2.2	8.2	22	24	1.8
		4	<5mm	32	10	3.2	0.5			2.7	3.2				
			5mm+				3.4		1.1	3.9	1.3	9.7	23	23	
		5	<5mm	31	5	1.6				1.6	1.6				
			5mm+				10.5	0.6	1.7	3.0	0.4	16.2	33	28	
		6	<5mm	23	25	5.8				5.8	5.8				
			5mm+				17.0	0.4	3.7	1.9	7.1	30.1	40	35	
		7	<5mm	72	10	7.2				7.2	7.2				
			5mm+				3.5	0.1	4.8	4.6	4.0	17.0	29	29	7.7
		8	<5mm	21	33	6.9				6.9	6.9				
	Totals					31.2	51.6	2.1	11.3	14.9	69.3	149.2		16.6	
F45	174										3.2	3.2			
	175						0.4				0.4	0.8	10	-	
	Totals						0.4	0.0	0.0	0.0	3.6	4.0			
F53	240	1	<5mm	53	10	5.3	0.2				5.1	5.3			
			5mm+								0.3	0.3	-	-	
		2	<5mm	101	5	5.1	0.1				5.1	5.2			
			5mm+				0.2				0.5	0.7	12	-	
	199	3	5mm+				1.1			2.2	1.0	4.3	16	52	0.1

	4	<5mm	70	1	0.7					0.7	0.7			
		5mm+				4.5	0.1	1.7	1.3		7.6	44	33	0.2
	5	<5mm	136	33	44.9	0.5	0.1			44.3	44.9			
		5mm+				39.3	0.3	11.7	2.9	11.7	65.9	42	46	
	6	<5mm	135	25	33.8	0.5	0.3			33.0	33.8			0.1
		5mm+				26.0	1.3	5.8	7.8	17.6	58.5	27	57	
	7	<5mm	143	25	35.8					35.8	35.8			
		5mm+				15.4		7.9	6.5	11.7	41.5	25	36	
	9	<5mm				0.5					0.5			
208		<5mm	987	1	9.9					9.9	19.7			
223						0.1				2.0	2.1			
224			1156	1	11.6	1.5			0.4	9.7	11.6			
267						10.0	0.1	1.3	1.3	26.9	39.6			
281											0.0			6.6
Totals					146.9	99.9	2.2	28.4	22.4	215.1	368.0			7.0

F59	287									0.5	0.5			
	289					11.5	12.2	30.5	102.7	29.2	186.1	35	94	3.3
	290					4.4	6.8	10.4	12.7	26.5	60.8	17	31	0.9
Totals						15.9	19.0	40.9	115.4	56.2	247.4			4.2

F83	346					4.3	1.0	1.8	4.5		11.6	36	30	
Totals						4.3	1.0	1.8	4.5	0.0	11.6			

F85	341									0.8	0.8			
	342					10.1	2.2	9.2	1.3	3.5	26.3	30	34	
Totals						10.1	2.2	9.2	1.3	4.3	27.1			

F87	393	<5mm	15	90	13.5					13.5	13.5			
		5mm+				59.3	24.7	20.8	44.5	81.8	231.1	30	42	
	395					0.2	1.8			1.9	3.9	14	-	

431	6	<5mm	25	5	1.3					1.3			
		5mm+					3.1	1.3	1.7	0.2	6.3	-	20
	7	5mm+				1.3			1.0	1.6	3.9	15	17
	8	5mm+				0.4				0.6	1.0	14	-
	9	<5mm	114	1	1.1						1.1		
		5mm+				2.0	2.3			2.5	6.8	18	-
Totals					15.9	63.2	31.9	22.1	47.2	102.1	266.5		
F93	592								5.4		5.4	-	28
Totals					0.0	0.0	0.0	0.0	5.4	0.0	5.4		
F101	412									3.5	3.5	-	-
F107	428									0.5	0.5		
Totals					0.0	0.0	0.0	0.0	0.0	4.0	4.0		
F102	430	4	<5mm							0.3	0.3		
		5	<5mm	36	1	0.4				0.4	0.4		
		6	<5mm	17	1	0.2				0.2	0.2		
		7	<5mm	174	25	43.5				43.5	43.5		
			5mm+				9.5	0.3	1.4	5.6	16.8	23	30
Totals					44.0	9.5	0.3	0.0	1.4	49.9	61.1		
F103	458	2	<5mm					0.1			0.1		
		3	<5mm	83	5	4.2				4.2	4.2		
			5mm+					10.5	0.7	4.2	15.4	-	42
		4	<5mm	95	5	4.8				4.8	4.8		
			5mm+					5.0	4.5	27.5	2.7	39.7	56
		5	<5mm	123	25	30.8			0.5	0.1	30.2	30.8	
			5mm+				12.2	24.6			24.9	103.7	25
		6	<5mm	161	80	128.8	0.5				128.3	128.8	
			5mm+				23.3	50.4	21.3	68.0	53.4	216.4	50

7	<5mm	273	25	68.3	0.1				68.2	68.3		
	5mm+				50.3	73	50.2	34.4	94.5	302.4	47	46
15	<5mm				0.2				0.2	0.4		
Totals				236.7	86.6	164.1	76.8	176.1	411.2	914.8		

F108	535								0.4	0.4		
Totals					0.0	0.0	0.0	0.0	0.4	0.4		

F114	542	3	<5mm	60	1	0.6				0.6	0.6				
		5	<5mm	120	1	1.2				1.2	1.2				
			5mm+				1.6	4.7		1.2	4.1	11.6	21	19	
		6	<5mm	58	5	2.9	0.1				2.8	2.9			
			5mm+				6.4	0.9	2.7	4.3	2.7	17.0	34	24	
		7	<5mm	70	33	23.1					23.1	23.1			
			5mm+				8.8	8.7	0.5	12.0	10.4	40.4	24	31	
		8	<5mm	57	10	5.7					5.7	5.7			
			5mm+				2.0	0.3		0.8	2.6	5.7	20	17	
		9	<5mm	133	5	6.7					6.7	6.7			
			5mm+					0.8	1.4	11.9	1.2	15.3	-	36	
		10	<5mm	96	5	4.8					4.8	4.8			
			5mm+				6.8		2.5	33.5	7.1	49.9	22	32	
		11	<5mm	82	1	0.8					0.8	0.8			
			5mm+					1.9	7.9		2.8	12.6	-	33	
		12	<5mm	90	25	22.5	0.2				22.3	22.5			
			5mm+				0.6				0.9	1.5	12	-	
		13	<5mm	131	10	13.1					13.1	13.1			
			5mm+				4.0	0.4	7.9	30.3	5.2	47.8	23	43	
		14	<5mm	503	90	452.7	3.0				449.7	452.7			
			5mm+				129.4	101.9	51.8	114.7	348.9	746.7	47	48	47.2
		15	<5mm	107	1	1.1					1.1	1.1			
			5mm+				0.5				2.7	3.2	12	-	
		-	5mm+				1.3					1.3	16	-	

Totals				535.1	164.7	117.7	68.7	216.6	920.4	1488.1			47.2		
F115	496					1.0	1.8	7.2		0.8	10.8				
	498	1	<5mm	108	5	5.4	1.8	0.1		3.5	5.4				
			5mm+				4.6	3.5	1.5	14.8	5.0	29.4	21	33	0.9
		2	<5mm	125	70	87.5	0.6	0.2	0.1		86.6	87.5			0.4
			5mm+				8.6	50.2	10.6	46.7	39.2	155.3	31	61	
		3	<5mm	57	80	45.6					45.6	45.6			
			5mm+				3.0	32.5	29.3	38.3	12.5	115.6	24	68	1.0
		4	<5mm	27	80	21.6					21.6	21.6			
			5mm+				9.4	24.3	18.7	58.4	22.2	133.0	45	55	
		5	<5mm	30	100	30.0	0.1			0.2	29.7	30.0			
			5mm+				2.3	17.1	11.4	30.9	20.8	82.5	37	57	
	Totals					190.1	31.4	129.6	78.9	189.3	287.5	716.7			2.3
F118	684						2.7			1.4	4.9	9.0	16	14	
	686		<5mm	93	25	23.3					23.3	23.3			
			5mm+				2.1	0.5	2.7	5.3	5.0	15.6	20	25	
	Totals					23.3	4.8	0.5	2.7	6.7	33.2	47.9			
F120	600		<5mm	6	50	3.0					3.0	3.0			
			5mm+				19.1	15.6	14.7	53.7	28.1	131.2	41	60	
	601		<5mm								1.9	1.9			
			5mm+				2.9	1.5	2.9	6.0	36.1	49.4	17	26	
	Totals					3.0	22.0	17.1	17.6	59.7	69.1	185.5			
F123	605										0.2	0.2			
	636		<5mm				1.0				8.6	9.6	9	-	1.1
	Totals						1.0	0.0	0.0	0.0	8.8	9.8			1.1
F126	566	2	<5mm	55	10	5.5	0.1	0.1			5.3	5.5			

	5mm+				1.4	0.1		0.9	0.5	2.9	20	23
3	<5mm	70	90	63.0	3.3	1.7			58.0	63.0		
	5mm+				18.0	1.9	1.2	4.0	11.1	36.2	26	31
Totals				68.5	22.8	3.8	1.2	4.9	74.9	107.6		

F128	671	1	<5mm						0.1	0.1		
		2	<5mm	73	5	3.7			3.7	3.7		
			5mm+				0.7		3.9	6.7	20	31
		3	<5mm	29	25	7.3			7.3	7.3		
			5mm+				1.9		13.5	3.3	20	40
		4	<5mm						0.2	0.2		
			5mm+					8.1	5.4	13.5	-	41
		5	5mm+				0.8	0.9	2.0	3.7	20	-
		6	<5mm	34	5	1.7			1.7	1.7		
			5mm+				4.9	1.5	7.4	18.3	44	50
		7	<5mm	50	1	0.5			0.5	0.5		
			5mm+				7.0	5.4	4.3	25.7	62	46
		8	<5mm	24	50	12.0			12.0	12.0		
			5mm+				9.9	5.6	16.8	29.5	40	40
		9	<5mm	63	90	56.7	0.1		56.6	56.7		
			5mm+				10.1	3.7	18.8	21.2	27	60
		10	<5mm	51	10	5.1			5.1	5.1		
			5mm+				0.4	2.6	1.3	9.3	16	59
		11	<5mm	72	10	7.2			7.2	7.2		
			5mm+				11.5	5.3		29.6	20	37
Totals						94.1	47.3	25	48.6	130.8	319.9	571.6

F129	616							4.0		4.0	-	18
	617							0.1		9.6	-	30
	627								1.6	1.7	-	19
	628	<5mm	8	90	7.2				7.2	7.2		
		5mm+				65.9	12.0	39.1	92.3	18.6	70	80

631				1.3		2.1	4.0		7.4	21	-	
	Totals		7.2	67.2	12.1	41.2	111.5	27.5	259.5			

F133	619							23.3		23.3	-	41
	Totals							23.3		23.3		

F135	688	4	5mm+					0.4	1.2	1.5	2.3	5.4	-	29	
		5	<5mm	78	20	15.6					15.6	15.6			
			5mm+						1.3	9.0	4.9	15.2	-	35	
		6	<5mm	48	60	28.8					28.8	28.8			
			5mm+				3.2	0.3	11.2	44.7	22.1	81.5	30	135	
		7	<5mm	76	70	53.2					53.2	53.2			
			5mm+				4.1	39.3	14.9	30.6	33.1	122.0	24	61	17.4
		8	<5mm	39	90	35.1	0.1				35.0	35.1			
			5mm+				15.2	16.8	12.6	21.9	21.6	88.1	35	48	7.4
		9	<5mm	73	25	18.3	0.1	0.3			17.9	18.3			
			5mm+				11.4	40.7	2.1	49.3	40.6	144.1	40	62	8.9
		10	<5mm	80	50	40.0		0.3			39.7	40.0			
			5mm+				49.0	11.9	11.3	32.0	38.0	142.2	40	55	
		11	<5mm	198	25	49.5					49.5	49.5			
			5mm+				65.9	8.4	12.7	16.4	60.3	163.7	40	48	18.7
		Totals				240.5	149.0	118.4	67.3	205.4	462.6	1002.7			52.4

F137	1084	3	<5mm	69	1	0.7					0.7	0.7			
			5mm+				0.3	9.5		4.6	2.2	16.6	13	-	
		4	<5mm	109	50	54.5					54.5	54.5			
			5mm+				40.5	37.6	40.6	9.0	94.9	222.6	31	68	
		5	<5mm	64	80	51.2	1.7				49.5	51.2			
			5mm+				29.0	35.2	20.2	36.8	44.0	165.2	50	50	
		6	<5mm	49	90	44.1					44.1	44.1			
			5mm+				46.0	24.8	25.0	15.0	40.9	151.7	66	63	
		7	<5mm	36	100	36.0	0.6	0.1			35.3	36.0			

	5mm+				17.2	22.5	8.3	23.4	23.2	94.6	30	52	
	Totals				186.5	135.3	129.7	94.1	88.8	389.3			

F141	981	2	5mm+							0.1	0.1						
		3	5mm+							0.2	0.2						
		4	<5mm	53	5	2.7				2.7	2.7						
			5mm+							0.8	0.8						
		5	5mm+							0.5	0.5						
		6	<5mm	76	5	3.8				3.8	3.8						
		7	5mm+						0.2	1.1	1.3	-	14				
		8	<5mm	83	1	0.8				0.8	0.8						
			5mm+							1.8	5.2	12	41				
		9	<5mm	105	1	1.1				1.1	1.1						
			5mm+							0.8	4.4	-	35				
		10	<5mm	83	5	4.2		0.2	0.3	3.7	4.2						
			5mm+							3.4	7.5	12	-	0.7			
		11	<5mm	91	10	9.1				9.1	9.1						
			5mm+							15.0	70.8	35	48				
		12	<5mm	400	25	100.0				100.0	100.0						
			5mm+							57.0	22.6	22.2	58.4	78.3	238.5	43	62
										7.6	5.6	5.4	21.1	123.3	163.0	23	40
		1003								9.5	4.9	14.4	-	59			
		1005															
		Totals				121.6	70.6	35.2	41.9	129.3	351.3	628.3			0.7		

F142	722	<5mm			0.0					9.2	9.2		
		5mm+				50.2	7.5	46.5	64.7	144.4	313.3	43	60
	725	1	5mm+			0.3				2.3	2.6	17	-
		2	<5mm	16	5	0.8				0.8	0.8		
			5mm+					0.3		1.3	1.9	16	-
		3	<5mm	14	10	1.4				1.4	1.4		
			5mm+				0.3	0.4		2.5	3.2	13	-
		4	<5mm	78	1	0.8				0.8	0.8		
			5mm+				0.7			3.9	4.6	16	-
		5	<5mm	35	1	0.4				0.4	0.4		
			5mm+				1.9		4.2	0.8	6.9	23	-
		6	<5mm	33	70	23.1				23.1	23.1		
			5mm+				0.6	24.2		37.2	62.0	25	89
		7	<5mm	51	80	40.8				40.8	40.8		
		5mm+				1.7	34.6	15.3	36.7	63.1	151.4	27	68
	8	<5mm	37	70	25.9					25.9	25.9		
		5mm+				1.4	19.9	3.2	9.3	25.7	59.5	32	46
	9	<5mm								50.2	50.2		
		5mm+				1.2	2.2	3.0	5.3	22.3	34.0	25	36
	795					4.0	2.6	2.1	2.8	45.0	56.5	24	17
	796					9.9	2.4	1.3	3.8	49.6	67.0	20	46
Totals					93.1	72.5	93.8	71.7	126.8	550.6	915.4		

F162	854					0.7	0.4			4.8	5.9	14	-
	864	1	5mm+			47.1	12.2	9.7	12.7	38.0	119.7	44	51
		2	5mm+			23.5	19.3	2.4	7.9	42.9	96.0	28	40
	865		<5mm	7	5	0.4				0.4	0.4		
	883									12.5	12.5		
	884		<5mm							1.7	1.7		
		5mm+				5.3	1.5		1.2	30.6	38.6	19	28
Totals					0.4	76.6	33.4	12.1	21.8	130.9	274.8		0.6

F165	859									0.6	0.6	-	17		
	871	1	<5mm	155	1	1.6				1.6	1.6				
			5mm+				1.7	0.6	1.5		3.2	7.0	20	20	
		2	<5mm	153	50	76.5	0.2				76.3	76.5			
			5mm+				14.4	9.0	5.6	55.9	53.0	137.9	33	66	5.7
	3	<5mm	358	50	179.0					179.0	179.0				
		5mm+				61.5	43.7	15.7	71.3	105.3	297.5	43	48		
	Totals					257.1	77.8	53.3	22.8	127.2	419.0	700.1		5.7	

F178	920	1	<5mm	121	5	6.1					6.1	6.1			
			5mm+				0.4			6.2	9.6	16.2	13	31	
		2	<5mm	74	10	7.4					7.4	7.4			
			5mm+				0.3	0.3	2.6	19.2	14.2	36.6	16	27	
		3	<5mm	79	80	63.2	0.4		0.2		62.6	63.2			
			5mm+				9.2	4.3	2.6	47.8	44.2	108.1	29	54	
		4	<5mm	118	90	106.2	0.3	0.1			105.8	106.2			
			5mm+				9.8	6.3	18.2	69.4	82.9	186.6	24	62	
		5	<5mm	129	50	64.5					64.5	64.5			
			5mm+				8.5	2.3	13.7	5.8	44.7	75.0	22	34	
	922					1.1		1.1		6.9	9.1	26	20		
	924					20.9	2.0	2.9	11.0	35.2	72.0	26	29	1.1	
	Totals					247.4	50.9	15.3	41.3	159.4	484.1	751.0		1.1	

F179	935	2							0.7		0.7	-	25		
	936	1	<5mm	101	10	10.1					10.1	10.1			
			5mm+				3.6	3.5	0.5	38.5	27.7	73.8	25	47	
		2	5mm+							6.2	7.2	13.4	-	44	
		3	<5mm	233	10	23.3					23.3	23.3			
		5mm+				3.8	3.7	10.8	42.7	55.6	116.6	22	51		
	Totals					33.4	7.4	7.2	12.0	87.4	123.9	237.9			

F180	929					5.8	0.6	2.5	32.2	10.4	51.5	26	39	1.0
	930	1	<5mm	44	50	22.0				22.0	22.0			
			5mm+				2.6	0.1	19.3	7.2	29.2	19	20	1.3
		2	<5mm	28	25	7.0				7.0	7.0			
			5mm+				0.4		2.9	7.8	11.1	-	30	
		3	<5mm	44	50	22.0	0.1			21.9	22.0			
			5mm+				1.3	4.5	21.4	16.3	43.5	14	57	
		4	<5mm	62	70	43.4	0.3			43.1	43.4			
			5mm+				1.8	7.4	23.0	24.5	102.1	30	60	
		5	<5mm	32	60	19.2	0.1			19.1	19.2			
			5mm+				12.1	1.0	9.3	9.7	16.8	26	35	
		6	<5mm	32	80	25.6				25.6	25.6			
			5mm+					1.5	30.2	12.5	44.2	-	38	
		7	<5mm	43	25	10.8				10.8	10.8			
			5mm+				1.4	1.7		2.8	5.9	21	25	
	-						2.4	1.7	6.2	8.3	18.6	20	27	
	around pot 1	<5mm	69	10	6.9					6.9	6.9			
	around pot 2	<5mm	36	10	3.6					3.6	3.6			
	Totals					160.5	28.3	12.3	41.0	167.3	266.6	515.5		2.3

F181	1105	2	<5mm	174	1	1.7				1.7	1.7			
			5mm+							1.5	1.5			
		4	<5mm	229	5	11.5				11.5	11.5			
			5mm+							1.7	1.7			
		5	5mm+								0.0			0.6
		6	5mm+								0.0			2.7
		7	5mm+					0.3			0.3			
		8	5mm+								0.0			3.6
		9	<5mm	112	1	1.1				1.1	1.1			
			5mm+							0.3	0.3			0.4
		11	5mm+				0.2			0.2	0.4	7	-	

	12	<5mm	470	1	4.7					4.7	4.7		
		5mm+				2.3				3.6	5.9	22	20
	13	<5mm	616	10	61.6					61.6	61.6		
		5mm+				25.2	2.4	3.4	3.4	58.4	92.8	27	37
		Totals			80.6	27.7	2.4	3.7	3.4	146.3	183.5		37.1

F182	970					0.9				15.8	13.6	30.3	31	58
	971	<5mm	24	25	6.0						6.0	6.0		
		5mm+				51.1	16.6	41.2	59.6	82.6	251.1	46	60	
	972	<5mm	392	10	39.2					39.2	39.2			
		5mm+				24.3	6.9	20.4	50.8	195.7	298.1	26	32	
		Totals			45.2	76.3	23.5	61.6	126.2	337.1	624.7			

F186	998	2	<5mm			0.0					0.1	0.1		
		3	<5mm	46	1	0.5					0.5	0.5		
		4	<5mm	47	10	4.7					4.7	4.7		
			5mm+				3.7	0.8	0.2	5.2	4.7	14.6	22	32
		5	<5mm	62	25	15.5	0.1			0.3	15.1	15.5		
			5mm+				6.3	0.3	5.3	6.7	18.5	37.1	30	30
		6	<5mm	142	25	35.5	0.3				35.2	35.5		
			5mm+				11.6	1.3	4.3	17.5	29.0	63.7	29	46
	999						7.2	1.0	0.4	1.6	13.5	23.7	20	20
		Totals			56.2	29.2	3.4	10.2	31.3	121.3	195.4			

F192	1034	1	<5mm	64	1	0.6					0.6	0.6		
		2	5mm+								1.3	1.3		
		3	<5mm	58	5	2.9					2.9	2.9		
			5mm+				0.4	0.5		0.9	0.8	2.6	13	18
		4	<5mm	56	5	2.8					2.8	2.8		
			5mm+					2.9	2.5	35.5	3.9	44.8	-	50
		5	<5mm	40	33	13.2					13.2	13.2		
			5mm+				68.4	5.4	21.7	35.1	43.0	173.6	46	47
														7.7

6	<5mm	88	90	79.2	0.1				79.1	79.2		
	5mm+				2.9	25.7	5.7	33.1	34.1	101.5	19	35
7	<5mm	334	25	83.5	0.5				83.0	83.5		
	5mm+				50.7	6.9	25.5	74.7	86.4	244.2	65	42
Totals				182.2	123.0	41.4	55.4	179.3	351.1	750.2		7.7

F195	1050	1	<5mm	33	5	1.7				1.7	1.7		
			5mm+					10.9	1.3	12.2	-	30	7.6
		2	<5mm	55	1	0.6			0.6	0.6			
			5mm+				11.8		1.0	5.4	18.2	35	45
		3	<5mm	61	5	3.1				3.1	3.1		
			5mm+				4.8	1.0		5.9	15.1	34	22
		4	<5mm	45	5	2.3				2.3	2.3		
			5mm+				21.4		10.8	7.0	9.0	46	62
		5	<5mm	56	90	50.4				50.4	50.4		
			5mm+				6.4	5.8		17.7	16.9	35	41
		6	<5mm	78	50	39.0				38.7	39.0		
			5mm+				68.6	7.8	31.1	48.3	44.2	49	56
		7	<5mm	164	50	82.0				81.8	82.0		14.4
			5mm+				32.5	1.7	53.7	64.9	100.3	45	62
Totals						178.9	146.0	16.3	95.6	153.2	361.4	772.5	27.4

F197	1059						2.9	5.8	11.3	14.2	31.6	65.8	25	46
	1067						4.0	0.3	3.1	3.4	23.6	34.4	18	29
	1076						3.4	1.8	3.5	0.8	43.5	53.0	20	21
Totals							10.3	7.9	17.9	18.4	98.7	153.2		

F198	1078	3	5mm+					0.2			1.2	1.4		
		4	<5mm	115	1	1.2					1.2	1.4		
			5mm+				7.0				0.2	7.2	34	-
		5	<5mm	91	10	9.1					9.1	9.1		
			5mm+				5.0	1.9	8.1	10.3	9.9	35.2	29	36

6	<5mm	168	33	55.4	0.8				55.4	56.2			
	5mm+				26.2	9.5	8.5	76.5	52.9	173.6	51	50	2.8
7	<5mm	76	90	68.4					68.4	68.4			
	5mm+				28.3	20.2	12.2	70.5	43.9	175.1	72	44	
8	<5mm	87	70	60.9	0.2	0.1			60.6	60.9			
	5mm+				16.0	11.8	31.8	50.4	65.1	175.1	50	50	
9	<5mm	80	25	20.0	0.2				19.8	20.0			
	5mm+				20.0	8.1	17.0	91.5	57.9	194.5	33	76	
10	<5mm	210	25	52.5					52.5	52.5			
	5mm+				13.5	3.0	6.7	31.9	43.6	98.7	33	41	
Totals				267.5	117.2	54.8	84.3	331.1	541.6	1129.0			2.8

F199	1062	<5mm			0.3	0.3			28.8	29.4	-	-	
		5mm+			16.9	7.3	3.5	3.3	80.5	111.5	28	31	4.0
	1064				15.6	2.2	28.2	14.7	31.2	91.9	39	68	1.5
	1066	1	5mm+						0.7	0.7	-	-	
		2	<5mm	38	5	1.9			1.9	2.0			
			5mm+						6.1	21.0	22	33	1.1
		3	<5mm	45	50	22.5			22.4	22.5			
			5mm+						6.3	26.3	34	134	5.9
		4	<5mm	181	25	45.3			44.8	45.3			
			5mm+						32.3	35.5	49	58	13.9
		7	<5mm						0.5	0.5			
Totals					69.7	73.7	72.2	87.1	82.9	317.6	633.5		26.4

F200	1168	2	<5mm	134	1	1.3			1.3	1.3							
			5mm+							2.6							
		3	5mm+						0.8	3.3	3.3	3.2	10.6	19	15	0.3	
		4	<5mm	172	1	1.7				1.7	1.7						
			5mm+						2.5	1.6	4.9	0.8	12.9	22.7	29	28	
		5	<5mm	100	5	5.0				5.0	5.0						
			5mm+						12.3	17.2	5.4	17.7	37.4	90.0	30	50	3.3

6	<5mm	88	10	8.8					8.8	8.8			
	5mm+				25.8	21.7	44.8	64.9	99.1	256.3	31	55	4.2
7	<5mm	96	50	48.0					48.0	48.0			
	5mm+				56.1	29.0	64.9	73.3	115.8	339.1	50	70	1.9
8	<5mm								34.9	34.9			
	5mm+				107.1	62.1	85.8	84.1	162.5	501.6	41	52	6.6
Totals				64.9	204.6	137.5	205.8	244.1	530.7	1322.7			16.3

F201	1177	2	<5mm	146	5	7.3				7.3	7.3		
			5mm+						0.5	0.6	1.1	15	-
		3	<5mm	58	25	14.5				14.5	14.5		
			5mm+					2.8	3.4	6.7	12.9	22	30
		4	<5mm	66	25	16.5			0.2	16.5	16.7		
			5mm+				1.5	7.8	9.1	14.9	37.2	31	45
	1178	5	<5mm	50	70	35.0				35.0	35.0		
			5mm+				4.0	6.9	23.0	28.2	88.1	42	52
		6	<5mm	71	80	56.8			0.3	56.5	56.8		
			5mm+				3.1	9.0	27.5	34.2	95.4	37	40
		7	<5mm	90	50	45.0				45.0	45.0		
			5mm+				3.4	27.3	75.9	40.8	162.7	52	64
Totals						175.1		51.0	139.9	12.0	69.6	300.2	572.7

F203	1181		<5mm	1498	33	494.3				494.3	494.3		
			5mm+						14.5	9.3	10.2	92.9	188.9
Totals						494.3		10.2	14.5	9.3	92.9	683.2	810.1
												23	35
													18.4

F204	1182							1.3	0.8	2.1		32	
	1183							12.4	5.6	0.8	18.8	55	
Totals						0.0	0.0	12.4	6.9	1.6	20.9		

F209	1194					1.1	0.4		0.3	0.3	2.1		
-------------	------	--	--	--	--	-----	-----	--	-----	-----	-----	--	--

Totals				1.1	0.4	0.0	0.3	0.3	2.1		
---------------	--	--	--	------------	------------	------------	------------	------------	------------	--	--

Bustum burials

Burial	Find No	Bone No	Skull Wt/g	Axial Wt/g	U limb Wt/g	L limb Wt/g	Unident Wt/g	Totals Wt/g	max frag (mm)	max skull (mm)	max l.b. (mm)	Animal Wt/g	Identified bones	
F47	205		2.3	7.2	19.2	17.7	41.4	87.8		20	40			
	245			1.6	0.8	24.1	27.4	53.9		-	35			
	298						11.8	11.8		-	-			
	516					12.2	47.7	59.9		-	22			
	517		16.2	2.3	3.7		13.4	35.6		27	20			
	518		3.0	2.3	6.2	5.4	23.5	40.4		24	28			
	519			1.5	1.2	12.0	10.8	25.5		-	27			
	520					11.3		11.3		-	30			
	522						0.6	0.6						
	528			3.6	3.4	2.4		20.4	29.8		18	23		
	1155	1		8.4					8.4	28				
		2		1.0		9.0			10.0	64				humerus
		3			7.3				7.3	42				axis, T vert arch
		4		10.4		0.2			10.6	47				temporal, small frag ?finger phal
		5		2.3					2.3	30				basi-occipital R.
		6		12.6					12.6	30				occipital
		7							0.0					missing?
	8			1.4	1.4		0.5	3.3	26				rib frags, convex joint	
	9				2.7			2.7	36				humerus?	
	10			0.6				0.6	35				vert, humerus	
	11			0.5				0.5	20				rib	
	12		3.9				1.8	5.7	33				thin, curled skull frags	
	13				4.0			4.0	46				ulna?	
	14		1.6					1.6	37				inner surface	
	15			1.3				1.3	23				vert frags?	
	16				0.6			0.6	27				metacarpal	
	17		4.2					4.2	26				mandible	

Burial	Find No	Bone No	Skull Wt/g	Axial Wt/g	U limb Wt/g	L limb Wt/g	Unident Wt/g	Totals Wt/g	max frag (mm)	max skull (mm)	max l.b. (mm)	Animal Wt/g	Identified bones
		18		2.9				2.9	35				ribs
		19		5.5				5.5	50				ribs
		20		1.0				1.0	21				ribs
		21		0.6				0.6	38				rib
		22			4.3			4.3	28				humerus
		23			6.9			6.9	32				ulna
		24			3.4			3.4	34				ulna
		25			4.8			4.8	43				ulna
		26		2.0				2.0	40				scapula
		27		1.2	0.5			1.7	35				ribs, ulna/radius
		28				2.8	0.2	3.0	44				femur
		29		5.0				5.0	37				lower T or L vert
		30		2.6				2.6	48				ribs
		31			32.6			32.6	26				distal L humerus
		32				2.9		2.9	41				femur
		33				4.2		4.2	30				femur
		34		7.6	19.1			26.7	45				large prox L ulna, radius, ilium
		35		4.9				4.9	41				ilium
		36				2.9		2.9	20				femur
		37		4.4				4.4	47				rib and ilium
		38			6.0			6.0	50				ulna
		39	0.3	1.1				1.4	26				?pelvis, molar roots
		40		3.6				3.6	36				ilium
		41		1.3		1.4		2.7	24				femur, ilium
		42		13.5		7.3		20.8	47				femur, ischium, ribs
		43					1.1	1.1	36				long bone?
		44		1.6				1.6	23				T vert frag, slight OP
		45		8.5				8.5	37				L vert and frags - small SN
		46				7.5		7.5	59				femur
		47		8.8		7.1		15.9	42				lower T verts, femur
		48				9.5		9.5	43				femur

Burial	Find No	Bone No	Skull Wt/g	Axial Wt/g	U limb Wt/g	L limb Wt/g	Unident Wt/g	Totals Wt/g	max frag (mm)	max skull (mm)	max l.b. (mm)	Animal Wt/g	Identified bones
		49				11.4		11.4	41				femur
		50				5.4		5.4	47				femur
		51			1.7	7.8		9.5	41				ulna, femur, tibia
		52				1.8		1.8	22				femur/tibia
		53					2.1	2.1	31				poss pelvis?
		54		9.7		2.0		11.7	35				acetabulum and femur head
		55		2.1				2.1	41				pelvis
		56				4.1		4.1	23				femur
		57		2.1				2.1	40				pelvis
		58					2.6	2.6	32				femur neck or sciatic notch
		59				2.7		2.7	32				femur
		60		27.4		9.3		36.7	63				ilium and ischium, femur shaft
		61				11.9		11.9	60				tibia (or poss femur?)
		62			1.0			1.0	22				finger middle phal
		63				2.0		2.0	29				tibia?
		64				9.5		9.5	46				tibia and fibula
		65				4.1		4.1	49				tibia
		66				9.8		9.8	74				tibia
		67				2.0		2.0	44				fibula
		68				0.6	2.1	2.7	23				tibia, 1 black frag poss animal
		69		12.8				12.8	34				pelvis (may be 70 on plan)
		70				2.3		2.3	30				distal femur (may be 69 on plan)
		71				3.7		3.7	29				tibia?
		72				4.8		4.8	45				tibia
		73				4.0		4.0	55				fibula
		74				9.3		9.3	31				tibia and fibula
		75				4.3		4.3	40				tibia
		76				2.7		2.7	37				tibia
		77				4.1		4.1	35				tibia tubercle
		78				4.6		4.6	48				tibia
		79				4.4		4.4	23				tibia

Burial	Find No	Bone No	Skull Wt/g	Axial Wt/g	U limb Wt/g	L limb Wt/g	Unident Wt/g	Totals Wt/g	max frag (mm)	max skull (mm)	max l.b. (mm)	Animal Wt/g	Identified bones
		80				1.1		1.1	17				fibula?
		81				5.3		5.3	33				tibia
		82				1.4		1.4	32				tibia
		83				8.9		8.9	60				tibia
		84				3.6		3.6	21				tibia
		85				3.3		3.3	43				tibia
		86				2.0		2.0	30				talus
		87					1.3	1.3	27				poss ulna/radius?
		88		2.0				2.0	30				sacrum (or L1)
		89				2.8		2.8	20				femur
		90				1.9		1.9	19				femur
		91				8.8		8.8	29				femur
		92		0.3		8.9		9.2	42				R patella, frag vert
		93			0.6			0.6	27				metacarpal
		94			1.7	1.4		3.1	33				distal radius, femur
		95			1.5			1.5	37				metacarpal
		96		1.5			2.1	3.6	31				rib and other frags
		97			3.7			3.7	30				humerus
		98		1.1		2.1		3.2	21				pelvis and femur
		99				3.2		3.2	30				femur
		100			3.6			3.6	35				humerus
		101		3.1				3.1	25				pelvis and vertebrae
		102				3.0		3.0	27				femur
		103	0.4	1.9	1.3			3.6	23				skull, ribs, humerus
		103				4.5		4.5	31				femur (NB 2 bags of 103)
		104	6.1				1.1	7.2	33				
		105		0.4				0.4	30				rib
		106		3.7				3.7	25				verts
		107					0.4	0.4	22				cancellous frag
		108	1.1	0.8			1.3	3.2	21				ribs, ?pelvis
		109		2.5				2.5	24				C vert

Burial	Find No	Bone No	Skull Wt/g	Axial Wt/g	U limb Wt/g	L limb Wt/g	Unident Wt/g	Totals Wt/g	max frag (mm)	max skull (mm)	max l.b. (mm)	Animal Wt/g	Identified bones
		110		2.5				2.5	24				C or upper T vert
		111			1.3			1.3	30				ulna?
		112					1.5	1.5	18				
		113		0.5			0.6	1.1	22				C vert
		114		1.2				1.2	36				scapula
		115					0.6	0.6	31				
		116	0.4		2.1			2.5	50				humerus
		117		5.3				5.3	27				atlas and C vert
		118			12.8			12.8	77				humerus
		119		1.6				1.6	32				rib
		120			1.9			1.9	43				humerus?
		121		0.4				0.4	25				rib
		122	2.6					2.6	46				R. mandibular ramus
		123				4.9		4.9	39				femur
		124		0.8	0.8			1.6	17				ribs, ulna/radius?
		125	1.7					1.7	24				maxilla and tooth root
		126		2.9				2.9	23				T vert
		127					0.8	0.8	19				vert??
		128			4.4			4.4	46				R. radius tubercle
		129			1.3			1.3	23				radius/ulna
		130		1.0				1.0	35				rib
		131			1.8			1.8	41				humerus
		132		0.3			1.8	2.1	24				vert and long bones, convex joint
		133		1.4				1.4	20				sternum
		134		0.8				0.8	31				ribs
		135	8.5					8.5	66				frontal
		136		0.4				0.4	18				rib and vert frags
		137	0.4					0.4	11				molar (upper)
		138	2.6	0.5				3.1	26				temporal and rib
		139	1.6					1.6	26				R. malar
		140	1.9					1.9	17				

Burial	Find No	Bone No	Skull Wt/g	Axial Wt/g	U limb Wt/g	L limb Wt/g	Unident Wt/g	Totals Wt/g	max frag (mm)	max skull (mm)	max l.b. (mm)	Animal Wt/g	Identified bones
		141		2.7				2.7	30				scapula
		142	0.4					0.4	17				2 tooth root frags, upper R. lat incisor + ?
		143			3.6			3.6	33				humerus
		144	14.3					14.3	25				in situ covers 64 x 98mm, lots of small frags
		145		0.4				0.4	19				rib
		146	0.5	0.7				1.2	20				ribs and skull
		147					1.3	1.3	21				
		148	0.8	1.0				1.8	30				skull and scapula
		149					0.9	0.9	26				
		150	1.2					1.2	30				inner surface
		151		1.7				1.7	29				rib
		152	1.1				0.6	1.7	45				mandible
		153		0.8				0.8	19				rib/vert?
		154					0.5	0.5	20				joint, slightly concave, poss scapula
		155	0.8	1.3				2.1	20				scapula and skull base
		156	2.8					2.8	25				
		157	0.4					0.4	16				lower molar
		158	0.1					0.1	10				tooth root
		159	3.0					3.0	24				temporal
		160		0.7				0.7	17				C vert
		161	4.5					4.5	30				basal frags
		162	5.2					5.2	40				including mandible
		163	0.1					0.1	10				
		164	12.8	0.7	1.8			15.3	32				maxilla, finger phal, vert, rib, frontal
		165			0.2			0.2	15				finger phal
		166	5.1					5.1	16				
		167	0.8					0.8	21				
			151.0	206.5	176.1	324.0	222.2	1079.8					

Burial	Find No	Bone. No	Skull Wt/g	Axial Wt/g	U limb Wt/g	L limb Wt/g	Unident Wt/g	Totals Wt/g	max frag (mm)	max skull (mm)	max l.b. (mm)	Animal Wt/g	Identified bones	
F134	691		0.9	1.0			1.0	2.9		14	-	4.9		
	692		3.7	1.7	0.8		23.5	29.7		23	-	1.0		
	811				1.8			1.8		-	14			
	813	<5mm	7.6	4.0	7.9	5.2	62.6	87.3		24	26	1.4		
	813	5mm+	32.1	24.2	10.0	28.2	344.6	439.1		31	32	18.4		
	846		7.1	6.7	2.7	4.0	14.1	34.6		32	19	1.9		
	1158	1			3.4			3.4	34				radius/ulna	
		2						0.0				0.7		
		2?		9.3	8.9	6.3	10.3	55.6	90.4		30	25	13.6	maxilla, ribs, verts, prox radius, femur
		3			1.7				1.7	37				rib
		4				0.9			0.9	20				humerus
		5				0.8			0.8	20				ulna
		6				1.1			1.1	17				humerus
		7		4.5					4.5	38				skull
		8						0.6	0.6	26				
		9					1.3		1.3	21				femur
		10					1.7		1.7	29				femur
		11		2.3					2.3	25				
		12						0.4	0.4	21				metacarpal or rib?
		13		0.7					0.7	26				
		14					35.8		35.8	62				distal L. femur
		15				5.5			5.5	35				humerus?
		16				0.6			0.6	39				metacarpal
	17			0.3				0.3	19				rib	
	18		0.5		1.2			1.7	24				humerus, metacarpal, skull	
	19			0.4				0.4	19				vert spine	
	20		1.5					1.5	22					
	21			1.1				1.1	38				rib	
	22			0.7				0.7	38				rib	
	23							0.0				1.3		

Burial	Find No	Bone. No	Skull Wt/g	Axial Wt/g	U limb Wt/g	L limb Wt/g	Unident Wt/g	Totals Wt/g	max frag (mm)	max skull (mm)	max l.b. (mm)	Animal Wt/g	Identified bones
		24		0.4			0.8	1.2	15				vert facet
		25				4.2		4.2	21				femur
		26				3.7		3.7	30				femur
		27		1.3				1.3	24				rib
		28			0.6			0.6	14				radius/humerus
		29					1.6	1.6	44				fibula/ulna?
		30				1.9		1.9	36				tibia
		31		6.7				6.7	31				mid T vert body, no OP
		32		1.7				1.7	36				rib
		33			2.6			2.6	31				humerus (or poss tibia)
		34			2.4			2.4	26				humerus
		35		1.1				1.1	21				rib
		36	1.0					1.0	26				
		37	1.1					1.1	17				
		38		2.1				2.1	30				C vert, no OP
		39		0.8				0.8	34				vert arch
		40						0.0				0.9	
		41		0.9				0.9	28				rib
		42			2.3			2.3	34				humerus/radius?
		43			1.1			1.1	27				ulna?
		44			1.4			1.4	34				ulna/radius
		45					0.7	0.7	22				
		46					1.2	1.2	21				poss femur or humerus
		47			10.7			10.7	38				humerus head
		48				27.8		27.8	72				femur shaft
		49				2.5		2.5	68				fibula
		50		2.5				2.5	35				scapula
		51			3.1			3.1	42				distal ulna
		52	1.3					1.3	34				mandible
		53						0.0				4.1	
		54		4.4				4.4	44				pelvis

Burial	Find No	Bone. No	Skull Wt/g	Axial Wt/g	U limb Wt/g	L limb Wt/g	Unident Wt/g	Totals Wt/g	max frag (mm)	max skull (mm)	max l.b. (mm)	Animal Wt/g	Identified bones
		55		1.5				1.5	37				rib
		56				2.4		2.4	31				femur
		57			1.6			1.6	31				humerus (or poss tibia)
		58		1.8				1.8	30				T vert
		59					0.3	0.3	23				
		60					0.5	0.5	23				
		61				0.2		0.2	14				toe phal
		62						0.0				1.3	
		63						0.0				1.0	
		64		0.9				0.9	34				rib
		65		1.0				1.0	29				rib
		66				1.7		1.7	28				fibula
		67			1.3			1.3	28				humerus?
		68		1.3				1.3	39				rib
		69			4.8			4.8	40				ulna
		70		1.2				1.2	28				vert arch
		71	0.8					0.8	20				
		72						0.0				0.3	
		73		19.3				19.3	76				L. ischium
		74						0.0				5.5	
		75				6.2		6.2	44				tibia
		76	0.4			4.2		4.6	28				femur and skull
		77		1.6				1.6	25				pelvis
		78					0.8	0.8	43				poss ilium?
		79					1.2	1.2	41				tibia or humerus?
		80		1.3			0.6	1.9	36				rib (labelled 86, but prob 80)
		81			1.8			1.8	31				radius?
		82		5.1				5.1	31				T vert body, slight OP
		83		4.8			1.8	6.6	26				pubis
		84				3.9		3.9	34				tibia?
		85			3.0			3.0	29				radius

Burial	Find No	Bone. No	Skull Wt/g	Axial Wt/g	U limb Wt/g	L limb Wt/g	Unident Wt/g	Totals Wt/g	max frag (mm)	max skull (mm)	max l.b. (mm)	Animal Wt/g	Identified bones
		86					1.1	1.1	22				poss medial clavicle or distal radius
		87	2.9					2.9	45				mandibular ramus
		88					2.2	2.2	30				
		89					0.7	0.7	29				poss animal (labelled 88)
		90		2.3				2.3	31				scapula inferior end
		91					1.4	1.4	21				
		92					1.2	1.2	16				poss skull
		93		2.0				2.0	25				T vert arch
		94	4.0					4.0	24				
		95						0.0				1.8	
		96				7.9		7.9	50				tibia/femur
		97				16.6		16.6	70				tibia and femur
		98				22.7		22.7	85				femur
		99		3.2			0.8	4.0	36			3.2	ischium (same as 73) and vert
		100		12.9				12.9	44				L vert body, SN
		101		2.3				2.3	40				L vert arch
		102	3.8					3.8	41				
		103		2.0				2.0	26				C vert body
		104						0.0				0.1	
		105					0.7	0.7	32				
		106		0.9				0.9	22				vert arch
		106		0.8				0.8	33				pelvis
		106	2.4					2.4					v. large unburnt lower M2 - residual?
		107				2.9		2.9	33				L. femur lesser tubercle
		108	3.1				0.6	3.7	28				frontal, maxilla
		109					3.2	3.2	46				poss ilium?
		110	1.5					1.5	28				L. malar
		111	1.0				0.2	1.2	25				
		112		1.6	1.3			2.9	32				ribs and humerus
		113				1.4		1.4	27				tibia
		114		1.4				1.4	37				rib

Burial	Find No	Bone. No	Skull Wt/g	Axial Wt/g	U limb Wt/g	L limb Wt/g	Unident Wt/g	Totals Wt/g	max frag (mm)	max skull (mm)	max l.b. (mm)	Animal Wt/g	Identified bones
		115			1.3			1.3	23				humerus?
		116				2.0		2.0	43				fibula
		117						0.0				1.5	
		118a				3.3		3.3	73				fibula
		118b		2.5			0.7	3.2	50				rib
		119			5.6			5.6	48				radius
		120			5.0			5.0	45				humerus (1 frag poss animal)
		121		1.5				1.5	30				rib
		122	2.0					2.0	31				
		123		1.1				1.1	34				rib
		124		0.7				0.7	39				rib
		124				5.1		5.1	49				L. femur head frag
		125					2.7	2.7	32				
		126					0.5	0.5	28				
		127	14.7					14.7	28				46 x 30mm in situ, lots of small frags
		128					0.8	0.8	30				long bone
		129				1.4		1.4	17				femur
		130				1.3		1.3	17				tibia
		131				1.6		1.6	22				tibia
		132	1.3					1.3	22				R. mand condyle
		133						0.0				0.9	
		134		7.8				7.8	41				L. scapula glenoid
		135		1.7				1.7	33				rib
		136						0.0				6.3	sheep calcaneus
		137		1.6				1.6	30				vert arch, upper T or C
		138			2.3			2.3	31				radius/humerus?
		139				2.2		2.2	40				tibia (may be humerus?), green stain
		140		2.0				2.0	32				ilium
		141		12.3				12.3	50				R. acetabulum
		142				54.6		54.6	70				prox shaft and head R. femur
		143		9.7				9.7	40				L4(?) body, large SN

Burial	Find No	Bone. No	Skull Wt/g	Axial Wt/g	U limb Wt/g	L limb Wt/g	Unident Wt/g	Totals Wt/g	max frag (mm)	max skull (mm)	max l.b. (mm)	Animal Wt/g	Identified bones
		144		14.8				14.8	50				L3(?) body, large SN
		145					1.4	1.4	30				long bone
		146				19.8		19.8	35				prox L. femur
		147		3.8				3.8	30				upper T vert
		148				19.1		19.1	90				R. tibia
		149	2.8					2.8	31				R. temporal
		150				13.4		13.4	41				tibia
		151		14.8				14.8	45				L vert
		152				6.1		6.1	38				tibia
		153		2.7				2.7	54				
		154				3.5		3.5	25				cuboid
		155				3.9		3.9	36				tibia
		156	2.6					2.6	34				
		157		8.1				8.1	46				R. sacrum
		158					1.5	1.5	40				
		159				1.3		1.3	34				tibia
		160		2.4				2.4	30				medial clavicle - fused
		161					1.0	1.0	24				
		162				33.3		33.3	160				tibia shaft
		163		1.8				1.8	30				ilium
		164		2.9				2.9	29				C vert
		165		2.4				2.4	25				T vert
		166	2.3	2.1				4.4	47				T vert and base of skull
		167	4.4					4.4	46				R. mandibular ramus
		168		1.8				1.8	33				C vert arch
		169		1.3				1.3	17				T vert body
		170		1.9				1.9	32				T vert arch
		171	7.8					7.8	51				basi-occipital
		172		6.3				6.3	45				manubrium
		173		1.8				1.8	49				rib
		174		4.4				4.4	35				axis

Burial	Find No	Bone. No	Skull Wt/g	Axial Wt/g	U limb Wt/g	L limb Wt/g	Unident Wt/g	Totals Wt/g	max frag (mm)	max skull (mm)	max l.b. (mm)	Animal Wt/g	Identified bones
		175	3.9					3.9	25				petrous temporal
		176				6.6		6.6	61				tibia
		177			5.9	0.2		6.1	45				ulna, ?humerus, metatarsal head
		178				0.9	1.4	2.3	39				metatarsal
		179		23.0				23.0	43				pelvis frags, L vert, large SN, small OP
		180	2.1	12.7	0.5	4.0	7.8	27.1	39			1.3	frags C7, lower T/L verts, pelvis, finger
		181						0.0				3.9	
		182				6.3		6.3	38				femur
		183				2.2		2.2	41				fibula
		184	20.8	1.7			0.3	22.8	47				occipital, rib
		185				5.2		5.2	37				femur
		186		20.6				20.6	65				R. ischium
		187		33.1				33.1	70				acetabulum and pelvis frags
		188				17.1		17.1	60				tibia
		189					4.5	4.5	19				v. fragmented long bone
		190		14.8				14.8	54				sacrum
		191		0.9				0.9	17			0.3	rib
		192	2.9					2.9	45				mandible
		193	1.3			2.7		4.0	36				prox tibia?
		194		2.5				2.5	23				ilium
		195						0.0				2.3	
		196				2.9		2.9	27				talus
		197		1.8				1.8	23				rib
		198		5.1				5.1	40				rib (2 separate bags - no. used twice)
		199	1.3				2.4	3.7	26				unident long bone
		200		0.9		15.5		16.4	47				tibia and C vert
		201						0.0				1.2	
		202	23.6					23.6	46				
		203		3.8				3.8	33				pelvis
		204				2.6		2.6	35				first metatarsal
		205		8.8				8.8	40				lower T vert, large SN

Burial	Find No	Bone. No	Skull Wt/g	Axial Wt/g	U limb Wt/g	L limb Wt/g	Unident Wt/g	Totals Wt/g	max frag (mm)	max skull (mm)	max l.b. (mm)	Animal Wt/g	Identified bones
		206		2.3				2.3	41				R pubis
		207		2.9				2.9	50				rib
		208	1.0					1.0	19				
		209		2.7				2.7	35				lower T vert arch
		210		1.1				1.1	19				T vert
		211				0.9		0.9	34				fibula?
		212		1.8				1.8	30				ilium
		213		2.3				2.3	45				iliac crest
		214				4.0		4.0	45				tibia/femur
		215		2.3				2.3	23				upper T vert
		216						0.0				1.8	
		217		5.9				5.9	27				T vert
		218						0.0				4.3	
		219						0.0				3.0	
		220			8.6			8.6	48				humerus
		221		2.4				2.4	36				atlas
		222						0.0				2.5	
		223		7.5				7.5	35				lower T vert, small SN
		224		2.7				2.7	62				rib
		225	2.7					2.7	37				
		226	7.2					7.2	43				
		227		3.0				3.0	26				upper T vert
		228				20.9	1.3	22.2	49				femur
		229		4.3				4.3	42				pelvis
		230		1.1				1.1	42				rib
		231		2.3				2.3	35				T vert arch
		232			9.4			9.4	44				humerus
		233			6.0			6.0	60				humerus
		234		5.8				5.8	30				mid T vert and mid sacral segment
		235		2.0				2.0	40				rib
		236	3.4	8.6		5.5	3.3	20.8	35			0.5	verts, patella, pelvis, dist fibula

Burial	Find No	Bone. No	Skull Wt/g	Axial Wt/g	U limb Wt/g	L limb Wt/g	Unident Wt/g	Totals Wt/g	max frag (mm)	max skull (mm)	max l.b. (mm)	Animal Wt/g	Identified bones
		237			2.9			2.9	35				humerus?
		238					2.3	2.3	26				poss animal?
		239		1.9				1.9	32				T vert arch
		240						0.0				2.5	
		241		1.7				1.7	42				rib
		242		2.8				2.8	40				L vert arch
		243		3.3				3.3	37				scapula glenoid
		244		9.9				9.9	41				pelvis
			201.6	466.3	128.5	466.1	555.9	1818.4				93.7	

Other features and layers

Feature	Find No.	Type	Skull Wt/g	Axial Wt/g	U limb Wt/g	L limb Wt/g	Unident Wt/g	Totals Wt/g	max skull (mm)	max l.b. (mm)	Animal Wt/g
F8	96	Pit		5.0				5.0	-	-	
F28	77	Ditch					0.6	0.6	-	-	0.7
F32	98	Pit/ditch			0.6	0.9		1.5	-	17	
F34	87	Pit	2.0	5.9	0.4	7.1	1.7	17.1	31	49	
F98	390	Ditch/pit				5.0		5.0	-	46	
Totals			2.0	10.9	1.0	13.0	2.3	29.2			0.7

Layer	Context	Trench	Mesh	Residue Wt/g	Approx bone %	Estimated bone Wt/g	Skull Wt/g	Axial Wt/g	U limb Wt/g	L limb Wt/g	Unident Wt/g	Totals Wt/g	max skull (mm)	max l.b. (mm)	Animal Wt/g
L1	222	21	<5mm 5mm+	19	25	4.8									
	262	20					9.6	28.3	8.6	9.2	4.8	4.8	-	41	9.5
	264	20						0.2	37.2	64.6	10.1	27.9	25	56	
	314	28					1.5			2.2	51.2	2.4	-	24	
										6.5		8.0	22	30	

	350	35	<5mm 5mm+	6	50	3.0					3.0	3.0			
L2	1007						11.9	1.9	14.9	20.0	46.3	95.0	34	48	
	6						4.5			4.8	17.5	26.8	22	26	2.3
	63						4.0					4.0			
L16	354									5.9		5.9			
L23	377										8.1	8.1			0.5
L36	1188	67					0.5	2.3	5.2			8.0			1.8
L38	1011										1.5	1.5			
L39/40	928									4.1		4.1			
										0.6		0.6			
Totals							32	32.7	65.9	117.9	142.5	391.0			14.1

Measurements: Max skull frag size 45mm, max long bone frag size 43mm.
Colours: Pale buff, grey, some white.
Teeth: None.
Pathology: Slight osteophytes on cervical vertebra and larger on one fragment of lower vertebra.

Cremation burial F36 (find no 94): adult ?female

Quantification: Total weight 33.9g: Skull 2.3g, axial 0.6g, upper limb 2.2g, lower limb 11.1g, unidentified 39.5g.
Description: Disturbed ?urned cremation.
Condition: Mostly small fragments, very incomplete. 49.0% identified.
Determination of age: Size, fused epiphyses.
Determination of sex: Bones appear small.
Identified elements: Mandibular ramus, cervical vertebra, ribs, distal finger phalanx.
Measurements: Max skull frag size 33mm, max long bone frag size 28mm.
Colours: Mainly white.
Teeth: 1 small fragment of tooth root.
Pathology: Nothing observed.

Cremation burial F41 (find nos 128, 129, 134, 140): i) unsexed adult; ii) child approx 8-12 years

Quantification: Total weight 166.8g: Skull 42.8g, axial 13.4g, upper limb 13.4g, lower limb 13.4g, unidentified 83.
Description: Urned cremation, find number 128 excavated in five spits.
Condition: Fair, some large pieces, very incomplete. 49.8% identified.
Determination of age: i) Axis odontoid process fused, most bones adult sized. ii) small fragment with unfused epiphyses unfused iliac crest of L. ilium of child, and fragment of lumbar vertebra.
Determination of sex: Both unsexed.
Identified elements: i) Mandible, axis, ribs. ii) skull, L. ilium and lumbar vertebra.
Measurements: Max skull frag size 35mm, max long bone frag size 40mm.
Colours: Cream-buff.
Teeth:

-	-	-	-	-	-	-	-	-	-	-	-	-	-	-	-
-	-	-	/	/	/	/	-	-	-	/	/	/	-	-	-

Double root premolar or molar fragment.
Pathology: Nothing observed.

Cremation burial F42 (find nos 133, 135, 136, 147, 150, 151, 152, 153, 176, 177, 189): i) child, approx 5-6 years; ii) child, approx 12+ years

Quantification: Total weight 370.7g: Skull 116.1g, axial 5.2g, upper limb 22.8g, lower limb 20.6g, unidentified 2 Animal 9.7g.
Description: Urned cremation, find numbers 136 and 153 excavated in four spits (nothing from spits 1-2).
Condition: Fair, some large pieces. 44.4% identified.
Determination of age: Metopic suture closed, some unfused epiphyses. i) state of tooth eruption (juvenile molars present at death); ii) distal metatarsal fused.

Determination of sex: No sexing criteria.
 Identified elements: Fragments of ribs, atlas, phalanges, metatarsal, fibula, mandible. Also one small fragment pro
 adult femur.
 Measurements: Max skull frag size 35mm, max long bone frag size 40mm.
 Colours: Cream, buff, white.
 Teeth: - - - - - | - - - / / ? - -
 Pathology: Nothing observed.

Cremation burial F44 (find nos 178, 182): child, approx 2-3 years

Quantification: Total weight 149.2g: Skull 51.6g, axial 2.1g, upper limb 11.3g, lower limb 14.9g, unidentified 1
 Animal 16.6g.
 Description: Urned cremation burial, find number 182 excavated in eight spits.
 Condition: Good, several large fragments. 53.6% identified.
 Determination of age: Unfused femoral epiphysis.
 Determination of sex: No sexing criteria.
 Identified elements: Frontal, zygoma, L. femur lesser tubercle, distal femoral epiphysis, petrous temporal.
 Measurements: Max skull frag size 40mm, max long bone frag size 35mm.
 Colours: Mostly pale buff/cream, some black.
 Teeth: Two root fragments.
 Pathology: Nothing observed.

Cremation burial F45 (find nos 174, 175): unknown

Quantification: Total weight 4.0g: Skull 0.4g, unidentified 3.6g.
 Description: Urned burial on its side. Presumably very disturbed.
 Condition: Poor, very incomplete. 10.0% identified.
 Determination of age: No ageing criteria.
 Determination of sex: No sexing criteria.
 Identified elements: Skull.
 Measurements: Max skull frag 10mm.
 Colours: Pale buff.
 Teeth: None.
 Pathology: Nothing observed.

Cremation burial F53 (find nos 199, 208, 223, 224, 240, 267, 281): child, c.3-5 years?

Quantification: Total weight 368.0g: Skull 99.9g, axial 2.2g, upper limb 28.4g, lower limb 22.4g, unidentified 2
 Animal 7.0g.
 Description: Urned cremation excavated in nine spits (find numbers 199 and 240).
 Condition: Good, several large pieces. 41.5% identified.

Determination of age: Unerupted permanent second and third molars, deciduous incisors present at death.
 Determination of sex: No sexing criteria.
 Identified elements: Mandible, maxilla, frontal, petrous temporal, cervical vertebrae, ribs, humerus shaft, distal metatarsal.
 Measurements: Max skull frag size 44mm, max long bone frag size 57mm.
 Colours: Mostly pale cream, occasional grey patches.
 Teeth: - - - - - - - - - - - - - - - - - U?
 - - - - - - - - - - - - - - - - - U? -
 Pathology: Nothing observed.

Feature F59 (find nos 287, 289, 290): adult male

Quantification: Total weight 247.4g: Skull 15.9g, axial 19.0g, upper limb 40.9g, lower limb 115.4g, unidentified : Animal 4.2g.
 Description: Disturbed urned cremation.
 Condition: Fair, some very large fragments, but very incomplete. 77.3% identified.
 Determination of age: Epiphyses fused, no obvious degeneration.
 Determination of sex: Large robust bones.
 Identified elements: Lumbar vertebrae, ribs, sacrum, femur, tibia.
 Measurements: Max skull frag size 35mm, max long bone frag size 94mm.
 Colours: Pale buff and light grey.
 Teeth: None.
 Pathology: Slight periosteal new bone growth on one tibia shaft fragment.

Cremation burial F83 (find no 346): unsexed adult

Quantification: Total weight 11.6g: Skull 4.3g, axial 1.0g, upper limb 1.8g, lower limb 4.5g, unidentified 0.0g.
 Description: Spread of cremated bone.
 Condition: Very incomplete, several large fragments. 100% identified.
 Determination of age: Bone size.
 Determination of sex: No sexing criteria.
 Identified elements: Skull, long bones.
 Measurements: Max skull frag size 36mm, max long bone frag size 30mm.
 Colours: Pale buff/cream.
 Teeth: None.
 Pathology: Nothing observed.

Cremation burial F85 (find nos 341, 342): unsexed mature adult

Quantification: Total weight 27.1g: Skull 10.1g, axial 2.2g, upper limb 9.2g, lower limb 1.3g, unidentified 4.3g.
 Description: Urned cremation burial.
 Condition: Fair, very incomplete, some large pieces. 84.1% identified.

Determination of age: Epiphyses fused, slight degeneration.
Determination of sex: No sexing criteria.
Identified elements: Ilium, humerus.
Measurements: Max skull frag size 30mm, max long bone frag size 34mm.
Colours: Pale buff/cream.
Teeth: None.
Pathology: Slight osteophytes at edge of iliac SIJ.

Cremation burial F87 (find nos 393, 395, 431): unsexed adult

Quantification: Total weight 266.5g: Skull 63.2g, axial 31.9g, upper limb 22.1g, lower limb 47.2g, unidentified 10;
Description: Urned cremation excavated in nine spits, of which the top five produced no bone.
Condition: Fair, a few large pieces. 61.7% identified.
Determination of age: Epiphyses fused, no obvious degeneration.
Determination of sex: No sexing criteria.
Identified elements: A few vertebral fragments, humerus, femur, fibula, tibia, etc.
Measurements: Max skull frag size 30mm, max long bone frag size 42mm.
Colours: Pale cream, white and dark grey fragments.
Teeth: None.
Pathology: Wormian bones present.

Cremation burial F93 (find no 592): unsexed adult

Quantification: Total weight 5.4g: Lower limb 5.4g.
Description: Disturbed cremation?
Condition: Good. 100% identified.
Determination of age: Size.
Determination of sex: No sexing criteria.
Identified elements: Femur?
Measurements: Max long bone frag size 28mm.
Colours: Cream.
Teeth: None.
Pathology: Nothing observed.

Cremation burial F101/F107 (find nos 412, 428): unsexed adult?

Quantification: Total weight 4.0g: Unidentified 4.0g.
Description: Disturbed cremation?
Condition: Poor, some not definitely burnt and could be animal. 0% identified.
Determination of age: Size.
Determination of sex: No sexing criteria.
Identified elements: None.
Measurements: None.

Colours: Buff/white.
Teeth: None.
Pathology: Nothing observed.

Cremation burial F102 (find no 430): child, approx 2-3 years

Quantification: Total weight 61.1g: Skull 9.5g, axial 0.3g, lower limb 1.4g, unidentified 49.9g.
Description: Urned cremation burial excavated in seven spits, nothing in the upper three.
Condition: Fair, some large pieces. 18.3% identified.
Determination of age: Unerupted molar crown fragments.
Determination of sex: No sexing criteria.
Identified elements: Petrous temporal, rib, vertebra, femoral shaft.
Measurements: Max skull frag size 23mm, max long bone frag size 30mm.
Colours: Pale buff.
Teeth: Upper left and lower left unerupted first permanent molars.
Pathology: Nothing observed.

Cremation burial F103 (find no 458): middle-aged ?female

Quantification: Total weight 914.8g: Skull 86.6g, axial 164.1g, upper limb 76.8g, lower limb 176.1g, unidentified 411.2g.
Description: Urned cremation burial excavated in ?seven spits (one bag labelled spit 15), nothing in spit 1.
Condition: Good, well preserved, some very large pieces. Two fragments of humerus in spit 7 have melted glass adhering. 55.1% identified.
Determination of age: Medial clavicle fused, some degeneration.
Determination of sex: Small bones.
Identified elements: R. pubis, C, T and L vertebrae, both ischia, medial clavicle, L. scapula glenoid, frags R. ilium, shaft and head, petrous temporals.
Measurements: Max skull frag size 23mm, max long bone frag size 30mm. FeHd 40mm.
Colours: Pale buff/cream, dark grey in several skull frags.
Teeth: 1 lower incisor tooth root.
Pathology: Slight osteophytes on ?L verts, slight new bone growth at L. SIJ. No Schmorl's nodes on superior vertebrae.

Cremation burial F108 (find no 535): unknown

Quantification: Total weight 0.4g: Unidentified 0.4g.
Description: Urned cremation burial?
Condition: Poor. 0% identified. May not be burnt and could be animal.
Determination of age: No ageing criteria.
Determination of sex: No sexing criteria.
Identified elements: None.

Measurements: None.
Colours: Pale buff.
Teeth: None.
Pathology: Nothing observed.

Cremation burial F114 (find no 542): middle-aged/old male

Quantification: Total weight 1488.1g: Skull 164.7g, axial 117.7g, upper limb 68.7g, lower limb 216.6g, unide 920.4g. Animal 47.2g.
Description: Urned cremation burial excavated in fifteen spits, nothing in spits 1, 2 and 4, very little in 3.
Condition: Good, well preserved, particularly large fragments of torso, but 30% of the bone was from the fraction of spit 14. 38.1% identified.
Determination of age: Cranial sutures partially obliterated, degenerative disease.
Determination of sex: Large occipital crest, robust bones.
Identified elements: Frontal, frags of 5 C, 11 T and 4 L vertebrae, ilium, ischium, femur, tibia.
Measurements: Max skull frag size 47mm, max long bone frag size 48mm.
Colours: Cream, occasionally dark grey, especially at ankles and inner fragments of thicker long bones.
Teeth: 2 tooth root fragments.
Pathology: OA Grade II anterior R. acetabulum and at least one rib facet on L. side of a lower T vertebra, lipping iliac crest, OP most lumbar and some thoracic vertebrae. Fragment of femoral shaft exostosis c.7mm long – torn muscle. No Schmorl's nodes in surviving vertebral bodies.

Cremation burial F115 (find nos 496, 498): young/middle-aged female

Quantification: Total weight 716.7g: Skull 31.4g, axial 129.6g, upper limb 78.9g, lower limb 189.3g, unide 287.5g. Animal 2.3g.
Description: Urned cremation burial excavated in five spits.
Condition: Good, well preserved, large fragments. One finger fragment in spit 2 with fuel ash slag ad 59.9% identified.
Determination of age: Epiphyses fused, beginnings of degenerative change.
Determination of sex: Bones medium-small, wide sciatic notch.
Identified elements: Mandibular ramus, frontal, axis, L. scapula glenoid, humerus heads and shafts, finger phalx proximal L. radius and ulna, distal R. radius, proximal femora, ilium, ischium, tibia shaft, ses bone.
Measurements: Max skull frag size 45mm, max long bone frag size 68mm. HuHd 35mm.
Colours: Buff/cream.
Teeth: 6 tooth root fragments. Left side of mandible with alveolus for M3.
Pathology: Septal aperture L.? Very very slight sharpening of some vertebral body borders.

Cremation burial F118 (find nos 684, 686): unsexed adult

Quantification: Total weight 47.9g: Skull 4.8g, axial 0.5g, upper limb 2.7g, lower limb 6.7g, unidentified 33.2g.

Description: Broken urned cremation.
Condition: Fair. 30.7% identified.
Determination of age: Epiphyses fused.
Determination of sex: No sexing criteria.
Identified elements: Mandible, rib, vertebra, tibia and femur.
Measurements: Max skull frag size 20mm, max long bone frag size 25mm.
Colours: Cream-white.
Teeth: None.
Pathology: Nothing observed.

Cremation burial F120 (find nos 600, 601): middle-aged female

Quantification: Total weight 185.5g: Skull 22.0g, axial 17.1g, upper limb 17.6g, lower limb 59.7g, unidentified 69.
Description: Casket cremation burial.
Condition: Fair. 62.7% identified.
Determination of age: Some degenerative changes.
Determination of sex: Size.
Identified elements: C vertebrae, ribs, L vertebrae, proximal radius, ilium, femur head and shaft.
Measurements: Max skull frag size 41mm, max long bone frag size 60mm. FeHd 35mm.
Colours: Mainly light brown/cream, a few grey/black pieces, e.g. fragments of ilium.
Teeth: None.
Pathology: Slight OP C vertebrae.

Cremation burial F123 (find nos 605, 636): infant?

Quantification: Total weight 9.8g: Skull 1.0g, unidentified 8.8g. Animal 1.1g (at least).
Description: Pyre debris or disturbed cremation burial?
Condition: Poor, chalky bone. 10.2% identified.
Determination of age: Size.
Determination of sex: No sexing criteria.
Identified elements: Skull vault.
Measurements: Max skull frag size 9mm.
Colours: White.
Teeth: 2 tooth root fragments. May be animal?
Pathology: Nothing observed.

Cremation burial F126 (find no 566): child, approx 9-12 months

Quantification: Total weight 107.6g: Skull 22.8g, axial 3.8g, upper limb 1.2g, lower limb 4.9g, unidentified 74.9g.
Description: Glass vessel cremation burial excavated in three spits, nothing in spit 1.
Condition: Good, some large pieces. 30.4% identified.
Determination of age: Tooth eruption.
Determination of sex: No sexing criteria.

Identified elements: Petrous temporal and basi-occipital, ribs, vertebrae, axis, humerus, femur.
Measurements: Max skull frag size 26mm, max long bone frag size 31mm.
Colours: Pale buff/cream.
Teeth: Unerupted upper first incisor, upper deciduous second molars, left permanent first and second m
Pathology: Nothing observed.

Cremation burial F128 (find no 671): i) unsexed older adult; ii) infant

Quantification: Total weight 571.6g: Skull 47.3g, axial 25.0g, upper limb 48.6g, lower limb 130.8g, unidentified 3
Description: Urned cremation burial excavated in eleven spits.
Condition: Good, well preserved, some large pieces. 44.0% identified.
Determination of age: i) Cranial sutures partially obliterated, degenerative disease. ii) Size.
Determination of sex: i) Occipital crest seems small but axis odontoid process is relatively large. ii) No sexing criteria.
Identified elements: i) Maxilla, axis, C verts, humerus head and shaft, pelvis, femoral head and distal fragments, pr
tibia. ii) Petrous temporal and a few long bone fragments of infant.
Measurements: Max skull frag size 62mm, max long bone frag size 59mm. FeHd 40+mm.
Colours: Pale buff, some white and a few black, especially cancellous fragments.
Teeth: - - - - / / / - | - - - - - - - - - -
- - - - - - - - - - | - - - - - - - - - -
1 premolar and 2 molar root fragments.
Pathology: OP vertebral fragment, inferior acetabular facet, lipping iliac crest and linea aspera. OA Grade II
head facet of a lower T vertebra. An unidentified fragment from spit 6 seems to show rapid new
growth, poss osteoarthritic or inflammatory?

Cremation burial F129 (find nos 616, 617, 627, 628, 631): middle-aged/old ?female

Quantification: Total weight 259.5g: Skull 67.2g, axial 12.1g, upper limb 41.2g, lower limb 111.5g, unidentified 2
Description: Disturbed urned cremation burial.
Condition: Good, several large fragments. 89.4% identified.
Determination of age: Some cranial sutures closed, some degeneration.
Determination of sex: Occipital crest prominent but not large.
Identified elements: Vertebrae, ribs, ulna, humerus, sacrum, femur, tibia.
Measurements: Max skull frag size 70mm, max long bone frag size 80mm.
Colours: Cream/buff.
Teeth: None.
Pathology: OP lower T and L vertebral bodies, lipping linea aspera. Not metopic.

Cremation burial F133 (find no 619): unsexed adult

Quantification: Total weight 23.3g: lower limb 23.3g.
Description: Urned cremation burial?
Condition: Good, large pieces. 100% identifiable.

Determination of age: Size.
 Determination of sex: No sexing criteria.
 Identified elements: Femur.
 Measurements: Max long bone frag size 41mm.
 Colours: White/grey.
 Teeth: None.
 Pathology: Nothing observed.

Cremation burial F135 (find no 688): middle-aged/old male

Quantification: Total weight 1002.7g: Skull 149.0g, axial 118.4g, upper limb 67.3g, lower limb 205.4g, unide 462.6g. Animal 52.4g.
 Description: Disturbed urned cremation burial excavated in eleven spits, nothing in 1-3.
 Condition: Good, well preserved, large fragments. 53.9% identified.
 Determination of age: Degenerative disease.
 Determination of sex: Large occipital crest, robust bones, large vertebrae.
 Identified elements: Zygoma, axis, C and L vertebrae, medial clavicle, distal humerus, distal radius, ulna shaft, ilium, and tibia shafts.
 Measurements: Max skull frag size 40mm, max long bone frag size 62mm (three frags of tibia = 135mm).
 Colours: Cream/buff. Animal bone is white and black and more abraded – presumably cooked first?
 Teeth: 1 tooth root.
 Pathology: Large OPs on C and L vertebrae, L4(?) has large OP on superior edge at R. side of body. OA I II medial clavicle. OP distal femur, distal acetabulum, SIJ. Lipping linea aspera and iliac crest.

Cremation burial F137 (find no 1084): sub-adult ?female, approx 16-18 years

Quantification: Total weight 837.2g: Skull 135.3g, axial 129.7g, upper limb 94.1g, lower limb 88.8g, unide 389.3g.
 Description: Amphora cremation burial excavated in seven spits, nothing in 1-2.
 Condition: Good, some large fragments. 53.5% identified.
 Determination of age: Tibia and femur epiphyses unfused but adult-sized, proximal radius just fused, distal unfused, occipital unfused.
 Determination of sex: MT1s small (distal end fused), occipital crest small.
 Identified elements: Frontal, maxilla, petrous temporals, basi-occipital, atlas, axis, humerus head and distal end, sc ilium, ischium, distal femur and R. patella, proximal tibia, distal tibia and fibula, first metatarsals, t
 Measurements: Max skull frag size 66mm, max long bone frag size 68mm.
 Colours: Cream/buff.
 Teeth:

| | | | | | | | | | | | | | | |
|---|---|---|---|---|---|---|---|---|---|---|---|---|---|---|
| - | - | / | / | / | / | / | - | / | / | / | / | - | - | - |
| - | - | - | - | - | - | - | - | - | - | - | - | - | - | - |

 9 fragments molar root, 3 incisors, 5 other root fragments.
 Pathology: Nothing observed.

Cremation burial F141 (find nos 981, 1003, 1005): middle-aged+ ?female

Quantification: Total weight 628.3g: Skull 70.6g, axial 35.2g, upper limb 41.9g, lower limb 129.3g, unidentified 3: Animal 0.7g.
 Description: Urned cremation burial excavated in twelve spits (981), nothing from spit 1.
 Condition: Good, several large fragments. 53.5% identified.
 Determination of age: Some degenerative changes.
 Determination of sex: Bones seem small.
 Identified elements: Mandible, ribs, vertebrae, scapula, pelvis, humerus, ulna, finger, femur, tibia, tarsal navicular.
 Measurements: Max skull frag size 43mm, max long bone frag size 62mm.
 Colours: Cream/buff. Some pieces in 1003 have Fe staining.
 Teeth: 4+ molar root fragments and at least 1 single root tooth.
 Pathology: OP some vertebral bodies.

Cremation burial F142 (find nos 722, 725, 795, 796): sub-adult male, approx 16-18 years

Quantification: Total weight 915.4g: Skull 72.5g, axial 93.8g, upper limb 71.7g, lower limb 126.8g, unidentified 5: Animal 0.7g.
 Description: Urned cremation burial excavated in nine spits (725).
 Condition: Good, some very large fragments, including near-complete vertebrae in lower spits. 39.9% ident
 Determination of age: Proximal tibia and femur epiphyses unfused, proximal femur partly fused. Adult-sized.
 Determination of sex: Prominent occipital crest, large fingers.
 Identified elements: Temporal, ribs, vertebrae, pelvis, sacrum, humerus, carpals, fingers, femur, tibia, cuboid, sesa
 toes.
 Measurements: Max skull frag size 43mm, max long bone frag size 89mm.
 Colours: Pale grey-black.
 Teeth: 1 unerupted molar crown fragment (M3?), 2 root fragments.
 Pathology: Nothing observed.

Cremation burial F162 (find nos 854, 864, 865, 883, 884): i) child, approx 3 years; ii) older unsexed adult

Quantification: Total weight 274.8g: Skull 76.6g, axial 33.4g, upper limb 12.1g, lower limb 21.8g, unidentified 1: Animal (fish) 0.6g.
 Description: Urned cremation burial excavated in two spits (864).
 Condition: Good, some large pieces. 52.4% identified.
 Determination of age: i) Tooth eruption. ii) Degenerative disease.
 Determination of sex: No sexing criteria.
 Identified elements: i) Basi-occipital, ribs, vertebrae, humerus, distal radius, femur shafts, calcaneus. ii) Rib, ulna, 1
 toe. Most fragments in 883 and 884 are adult.
 Measurements: Max skull frag size 44mm, max long bone frag size 51mm.
 Colours: Pale buff.
 Teeth: - - U - - - U - | U U U - - U - -

Pathology: - - U e d - - - - - c d e U - -

Cremation burial F165 (find nos 859, 871): unsexed middle-aged+ adult

Quantification: Total weight 700.1g: Skull 77.8g, axial 53.3g, upper limb 22.8g, lower limb 127.2g, unidentified 4 Animal 5.7g.

Description: Urned cremation burial excavated in three spits (871).

Condition: Good, some large fragments. 40.2% identified.

Determination of age: Some degenerative changes.

Determination of sex: Large occipital crest, but C verts fairly small.

Identified elements: Atlas, axis, C verts, ribs, humerus head and distal fragment, proximal femur, ilium, ischium, navicular.

Measurements: Max skull frag size 43mm, max long bone frag size 66mm.

Colours: Pale buff.

Teeth: - - - - - | - - - / / X - -

Pathology: Slight lipping inferior acetabulum. OA Grade II distal humerus, eburnation head of radius. aperture R.

Cremation burial F178 (find nos 920, 922, 924): sub-adult ?male, approx 16 years

Quantification: Total weight 751.0g: Skull 50.9g, axial 15.3g, upper limb 41.3g, lower limb 159.4g, unidentified 4 Animal 1.1g.

Description: Disturbed urned cremation burial excavated in five spits.

Condition: Good, several large fragments. 35.5% identified.

Determination of age: Unfused distal ulna.

Determination of sex: Prominent occipital crest, cortical bone very thick.

Identified elements: Ulna, fingers, ribs, ischium, femur, tibia.

Measurements: Max skull frag size 29mm, max long bone frag size 62mm.

Colours: Cream/buff.

Teeth: 2 tooth roots.

Pathology: Nothing observed.

Cremation burial F179 (find nos 935, 936): unsexed middle-aged+ adult

Quantification: Total weight 237.9g: Skull 7.4g, axial 7.2g, upper limb 12.0g, lower limb 87.4g, unidentified 123.9

Description: Disturbed urned cremation burial excavated in three spits.

Condition: Fair, a few large pieces. 47.9% identified.

Determination of age: Some degeneration.

Determination of sex: No sexing criteria.

Identified elements: Femur shaft.

Measurements: Max skull frag size 25mm, max long bone frag size 51mm.
 Colours: Pale buff. Some white/dark blue-grey fragments may be animal?
 Teeth: None.
 Pathology: Lipping of linea aspera.

Cremation burial F180 (find nos 929, 930): adult ?male

Quantification: Total weight 515.5g: Skull 28.3g, axial 12.3g, upper limb 41.0g, lower limb 167.3g, unidentified 21.2g
 Animal 2.3g (pig teeth).
 Description: Urned cremation burial excavated in seven spits.
 Condition: Good, some large fragments. 48.3% identified.
 Determination of age: Epiphyses fused.
 Determination of sex: Large occipital crest.
 Identified elements: C vertebrae, humerus, femur, tibia.
 Measurements: Max skull frag size 30mm, max long bone frag size 60mm.
 Colours: Pale buff, some brown/black – possibly animal?
 Teeth: 7 tooth root fragments including canine.
 Pathology: Nothing observed.

Cremation burial F181 (find no 1105): unsexed older adult

Quantification: Total weight 183.5g: Skull 27.7g, axial 2.4g, upper limb 3.7g, lower limb 3.4g, unidentified 147.7g
 Animal 37.1g.
 Description: Urned cremation burial excavated in thirteen spits.
 Condition: Poor, abraded. 20.3% identified.
 Determination of age: Degenerative disease.
 Determination of sex: No sexing criteria.
 Identified elements: Maxilla, proximal radius, distal humerus, toe.
 Measurements: Max skull frag size 27mm, max long bone frag size 37mm.
 Colours: Pale buff, animal bone white.
 Teeth:

| | | | | | | | | | | | | | | | |
|---|---|---|---|---|---|---|---|---|---|---|---|---|---|---|---|
| - | - | - | - | X | / | X | / | - | - | - | - | - | - | - | - |
| - | - | - | - | - | - | - | - | - | - | - | - | - | - | - | - |

 Pathology: 4 tooth root fragments including a molar.
 Possibly osteoporotic. OP in ?L vertebra. Poss OA on distal end of a toe phalanx, but may be preservation.

Cremation burial F182 (find nos 970, 971, 972): ?old male

Quantification: Total weight 624.7g: Skull 76.3g, axial 23.5g, upper limb 61.6g, lower limb 126.2g, unidentified 359.1g
 Description: Unurned cremation or pyre debris.
 Condition: Good, several large pieces. 46.0% identified.
 Determination of age: Degenerative changes, tooth loss.

Determination of sex: Large occipital and fingers.
 Identified elements: Occipital, mandible, ribs, acetabulum, pelvis, humerus, ulna, radius, carpals, fingers, femur, tibia.
 Measurements: Max skull frag size 46mm, max long bone frag size 60mm.
 Colours: Cream-pale buff.
 Teeth:

| | | | | | | | | | | | | | | | | | |
|---|---|---|---|---|---|---|---|---|---|---|---|---|---|---|---|---|---|
| - | - | - | - | - | - | - | - | - | - | - | - | - | - | - | - | - | - |
| X | X | X | / | / | / | / | - | - | - | - | - | - | - | - | - | - | - |

 2 tooth roots: molar and premolar?
 Pathology: Large OP femur head fragment, one L vert body and, large OPs and porosity of a vertebral facet.

Crementation burial F186 (find nos 998, 999): child approx 12+ years

Quantification: Total weight 195.4g: Skull 29.2g, axial 3.4g, upper limb 10.2g, lower limb 31.3g, unidentified 121.
 Description: Urned cremation burial excavated in six spits, nothing in top spit.
 Condition: Good, some large pieces. 37.9% identified.
 Determination of age: Unfused epiphyses. MC1 head recently fused.
 Determination of sex: No sexing criteria.
 Identified elements: Maxilla, mandible, petrous temporal, ribs, prox humerus, capitate, finger, femur, distal tibia.
 Measurements: Max skull frag size 30mm, max long bone frag size 46mm.
 Colours: Pale cream.
 Teeth:

| | | | | | | | | | | | | | | | | | |
|---|---|---|---|---|---|---|---|---|---|---|---|---|---|---|---|---|---|
| - | - | - | - | - | 3 | / | / | - | - | - | - | - | - | - | - | - | - |
| - | - | - | - | - | - | / | / | / | / | / | - | - | - | - | - | - | - |

 Pathology: Nothing observed.

Crementation burial F192 (find no 1034): i) adult female; ii) unsexed adult

Quantification: Total weight 750.2g: Skull 123.0g, axial 41.4g, upper limb 55.4g, lower limb 179.3g, unide 351.1g. Animal 7.7g.
 Description: Urned cremation burial excavated in seven spits. Same as F195?
 Condition: Good, well preserved. 53.2% identified.
 Determination of age: Epiphyses fused. At least one of the individuals had degenerative changes.
 Determination of sex: i) Occipital crest gracile. ii) No sexing criteria.
 Identified elements: Mandible, R. scapula, humerus head, femur, tarsal navicular.
 Measurements: Max skull frag size 65mm, max long bone frag size 50mm.
 Colours: Mostly pale buff, some skull fragments white and grey (possibly the second individual).
 Teeth: 1 molar and 1 single root frag.
 Pathology: Large OP on T and L vertebrae, new bone growth linea aspera, lipping R. scapula glenoid.

Crementation burial F195 (find no 1050): i) adult; ii) older male

Quantification: Total weight 772.5g: Skull 146.0g, axial 16.3g, upper limb 95.6g, lower limb 153.2g, unide 361.4g. Animal 27.4g.
 Description: Urned cremation burial excavated in seven spits. Same two individuals as F192?

Condition: Good, well preserved. 53.2% identified. Some fragments of (ii) abraded.
Determination of age: i) No sexing criteria. ii) Large and robust.
Determination of sex: i) Lambdoid suture obliterated internally, but patent externally. ii) Degenerative changes.
Identified elements: Frontal, parietal, occipital, scapula, ribs, pelvis, humerus, radius tubercle, ulna shaft, femur, p tibia, fibula, talus, toes.
Measurements: Max skull frag size 49mm, max long bone frag size 62mm.
Colours: Skull brown, black and white.
Teeth: 1 tooth root fragment.
Pathology: ii) Small fragments of vertebrae with large OPs.

Cremation burial F197 (find nos 1059, 1067, 1076): adult female

Quantification: Total weight 153.2g: Skull 10.3g, axial 7.9g, upper limb 17.9g, lower limb 18.4g, unidentified 98.7
Description: Unurned cremation burial or pyre debris.
Condition: Good, some large fragments. 35.6% identified.
Determination of age: Epiphyses fused, tooth roots fully formed.
Determination of sex: Small.
Identified elements: Ribs, proximal radius, distal ulna, fingers, femur, patella, tarsals.
Measurements: Max skull frag size 25mm, max long bone frag size 46mm.
Colours: Light brown/cream.
Teeth: 8 tooth root frags, including 4 molars.
Pathology: Nothing observed.

Cremation burial F198 (find no 1078): middle-aged/old ?male

Quantification: Total weight 1129.0g: Skull 117.2g, axial 54.8g, upper limb 84.3g, lower limb 331.1g, unide 541.6g. Animal 2.8g.
 Description: Urned cremation burial excavated in ten spits, nothing in 1-2.
 Condition: Good, some very large pieces. 52.0% identified.
 Determination of age: Cranial sutures closed but not obliterated, several teeth lost ante-mortem, degenerative changes
 Determination of sex: Robust bones, occipital crest fairly prominent.
 Identified elements: Occipital, maxilla, mandible, clavicle, L. scapula, C, T and L vertebrae, ribs, humerus, ulna, femur, tibia.
 Measurements: Max skull frag size 72mm, max long bone frag size 76mm. FeHd c.45mm.
 Colours: Pale buff, occasional grey/black.
 Teeth:

| | | | | | | | | | | | | | | | | |
|---|---|---|---|---|---|---|---|---|---|---|---|---|---|---|---|---|
| - | - | - | - | - | - | - | - | - | X | X | X | / | / | / | - | - |
| - | - | - | - | - | - | - | - | - | - | - | - | - | - | - | - | - |

2 molars and one other root frags.

Pathology: Lipping of linea aspera, medium OP on some vertebral bodies and lipping of vertebral facets at (both bones). Periosteal reaction L. tibia shaft. Small fragment of ?skull with new bone g probably pathological but cause unknown.

Cremation burial F199 (find nos 1062, 1064, 1066): adult female

Quantification: Total weight 633.5g: Skull 73.7g, axial 72.2g, upper limb 87.1g, lower limb 82.9g, unidentified 3 Animal 26.4g.
 Description: Urned cremation burial excavated in ?seven spits (nothing below spit 4 except 5 small fragme skull in spit 7).
 Condition: Good, some very large fragments. 49.9% identified.
 Determination of age: Epiphyses fused.
 Determination of sex: Bones small, gracile.
 Identified elements: Maxilla, mandible, axis, C vertebrae, ribs, humerus shafts, ulna, fingers, proximal L. femur, ilii ischium, tibia.
 Measurements: Max skull frag size 49mm, max long bone frag size 134mm. FeHd c.38mm.
 Colours: Pale buff, occasional black cancellous fragments.
 Teeth:

| | | | | | | | | | | | | | | | | |
|---|---|---|---|---|---|---|---|---|---|---|---|---|---|---|---|---|
| - | - | - | - | - | - | - | - | - | / | / | / | / | / | - | - | - |
| - | - | - | / | / | / | / | / | / | / | / | - | - | - | - | - | - |

Roots of 1 molar, 1 incisor, 1 canine, 2 premolars.

Pathology: Nothing observed.

Cremation burial F200 (find no 1168): ?young ?male (but mirror in urn suggests a female)

Quantification: Total weight 1322.7g: Skull 204.6g, axial 137.5g, upper limb 205.8g, lower limb 244.1g, unide 530.7g. Animal 16.3g.
 Description: Urned cremation burial excavated in eight spits, nothing in spit 1.

Condition: Good, several large pieces. 59.9% identified.
 Determination of age: Epiphyses fused, no degeneration.
 Determination of sex: Seems large and robust.
 Identified elements: Zygoma, mandible, C verts, T verts, scapula, distal humerus, ulna, distal radius, carpals, ilium, prox and dist, tibia, fibula, tarsals, MT1.
 Measurements: Max skull frag size 50mm, max long bone frag size 70mm.
 Colours: Cream-buff, inner fragments occasionally grey.
 Teeth: - - - - - / / / / / - - -
 Pathology: Osteochondritis dissecans R. distal humerus medial facet, oval 11 x 5mm.

Cremation burial F201 (find nos 1177, 1178): adult ?female

Quantification: Total weight 572.7g: Skull 139.9g, axial 12.0g, upper limb 51.0g, lower limb 69.6g, unidentified 36.2g.
 Description: Urned cremation burial excavated in seven spits, nothing in spit 1.
 Condition: Good, large fragments. 47.6% identified.
 Determination of age: Epiphyses fused.
 Determination of sex: Small.
 Identified elements: Ribs, vertebrae, distal humerus, proximal radius, tibia.
 Measurements: Max skull frag size 52mm, max long bone frag size 64mm.
 Colours: Pale buff.
 Teeth: None.
 Pathology: Nothing observed.

Cremation burial F203 (find no 1181): unsexed middle-aged+ adult

Quantification: Total weight 810.1g: Skull 14.5g, axial 9.3g, upper limb 10.2g, lower limb 92.9g, unidentified 63.2g.
 Description: Un-urned cremation burial.
 Condition: Fair, very incomplete, small fragments. 15.7% identified.
 Determination of age: Degenerative changes.
 Determination of sex: No sexing criteria.
 Identified elements: C vertebrae, ribs, fingers, femur.
 Measurements: Max skull frag size 23mm, max long bone frag size 35mm.
 Colours: Pale buff, some black, especially inner surfaces.
 Teeth: 3 tooth root fragments: 1 molar, 1 premolar?, 1 canine?
 Pathology: Slight OP C vertebrae.

Cremation burial F204 (find nos 1182, 1183): unsexed adult

Quantification: Total weight 20.9g: Upper limb 12.4g, lower limb 6.9g, unidentified 1.6g.
 Description: Disturbed cremation.

Condition: Fair, very incomplete. 92.3% identified.
 Determination of age: Size.
 Determination of sex: No sexing criteria.
 Identified elements: Humerus.
 Measurements: Max long bone frag size 55mm.
 Colours: Pale cream.
 Teeth: None.
 Pathology: Nothing observed.

Cremation burial F209 (find no 1194): infant

Quantification: Total weight 2.1g: Skull 1.1g, axial 0.4g, lower limb 0.3g, unidentified 0.3g.
 Description: Urned cremation burial.
 Condition: Fair, small fragments. 85.7% identified.
 Determination of age: Very small.
 Determination of sex: No sexing criteria.
 Identified elements: Vertebrae.
 Measurements: -
 Colours: White.
 Teeth: None.
 Pathology: Nothing observed.

Bustum burials

Cremation burial F47 (find nos 205, 245, 298, 516-520, 522, 528, 1155): middle-aged male

Quantification: Total weight 1079.8g: Skull 151.0g, axial 206.5g, upper limb 176.1g, lower limb 324.0g, unide 222.2g.
 Description: Bustum burial.
 Condition: Good, some very large fragments. 79.4% identified.
 Determination of age: Ante-mortem tooth loss, some degeneration.
 Determination of sex: Mastoid medium, very large ulna, robust bones.
 Identified elements: Most areas of the skeleton represented.
 Measurements: Max frag size 77mm.
 Colours: Cream, black, grey, buff.
 Teeth:

| | | | | | | | | | | | | | | | |
|---|---|---|---|---|---|---|---|---|---|---|---|---|---|---|---|
| - | - | - | - | - | - | 2 | - | - | - | - | / | 5 | X | / | - |
| - | - | - | - | - | - | - | - | - | - | - | - | / | / | / | / |

 Pathology: Slight OP on T vert fragment.

Cremation burial F134 (find nos 691, 692, 811, 813, 846, 1158): ?middle-aged female

Quantification: Total weight 1818.4g: Skull 201.6g, axial 466.3g, upper limb 128.5g, lower limb 466.1g, unide

Description: 555.9g. Animal 93.7g.
 Bustum burial.
 Condition: Good, some very large fragments. 69.4% identified.
 Determination of age: State of pubis, some degenerative changes.
 Determination of sex: Sub-pubic angle wide, bones small and gracile, but occipital crest fairly prominent.
 Identified elements: Most areas of the skeleton represented.
 Measurements: Max frag size 160mm. HuHd 38mm, FeHd 38mm.
 Colours: Cream, buff, occasionally black.
 Teeth:

| | | | | | | | | | | | | | | | | |
|---|---|---|---|---|---|---|---|---|---|---|---|---|---|---|---|---|
| - | - | - | - | / | / | 2 | / | | - | - | - | - | / | 6 | - | - |
| / | / | / | / | / | / | - | - | - | - | - | - | - | - | - | - | - |

Pathology: One extra unburnt tooth, a large lower molar (labelled 106), was also present.
 Large Schmorl's nodes in L vertebrae. Slight lipping superior border L4(?), medium OP on su border L3(?).

Other features

Pit F8 (find no 96): unsexed adult

Quantification: Total weight 5.0g: axial 5.0g.
 Description: Fragments from a pit, probably redeposited.
 Condition: Good. 100% identified.
 Determination of age: Size.
 Determination of sex: No sexing criteria.
 Identified elements: Fragment of rib and piece of acetabulum.
 Measurements: None.
 Colours: Cream.
 Teeth: None.
 Pathology: Nothing observed.

Ditch F28 (find no 77): unknown

Quantification: Total weight 0.6g: unidentified 0.6g. Animal 0.7g.
 Description: Fragments from a ditch fill. May not be human.
 Condition: Poor, small.
 Determination of age: No ageing criteria.
 Determination of sex: No sexing criteria.
 Identified elements: None.
 Measurements: None.
 Colours: Cream.
 Teeth: None.
 Pathology: Nothing observed.

Pit/ditch F32 (find no 98):

Quantification: Total weight 1.5g: upper limb 0.6g, lower limb 0.9g.
Description: Fragments from a pit.
Condition: Fair, small. 100% identified.
Determination of age: No ageing criteria.
Determination of sex: No sexing criteria.
Identified elements: None.
Measurements: Max long bone frag size 17mm.
Colours: Cream.
Teeth: None.
Pathology: Nothing observed.

Pit F34 (find no 87): unsexed adult

Quantification: Total weight 17.1g: Skull 2.0g, axial 5.9g, upper limb 0.4g, lower limb 7.1g, unidentified 1.7g.
Description: A few fragments from a pit.
Condition: Fair, some large pieces. 90.0% identified.
Determination of age: Size.
Determination of sex: Clavicle seems small and gracile, but tibia is large. Possibly more than one individual?
Identified elements: R. clavicle, ribs, tibia shaft.
Measurements: Max skull frag size 31mm, max long bone frag size 49mm.
Colours: Cream.
Teeth: None.
Pathology: Nothing observed.

Ditch/pit F98 (find no 390): unsexed adult

Quantification: Total weight 5.0g: lower limb 5.0g.
Description: Fragments from a pit or ditch fill.
Condition: Fair, some large.
Determination of age: Size.
Determination of sex: No sexing criteria.
Identified elements: Femur/tibia.
Measurements: Max long bone frag size 46mm.
Colours: Cream.
Teeth: None.
Pathology: Nothing observed.

Layer L1 (find no 222): unsexed adult

Quantification: Total weight 30.7g: upper limb 8.6g, lower limb 9.2g, unidentified 12.9g. Animal 9.5g.
Description: Fragments from L1 in T21.
Condition: Fair. 58.0% identified.

Determination of age: Size.
Determination of sex: No sexing criteria.
Identified elements: Humerus, femur.
Measurements: Max long bone frag size 41mm.
Colours: Cream.
Teeth: None.
Pathology: Nothing observed.

Layer L1 (find nos 262, 264): adult male

Quantification: Total weight 193.3g: Skull 9.6g, axial 28.5g, upper limb 37.2g, lower limb 66.8g, unidentified 51.2
Description: Fragments from two find numbers in L1 T20 – possibly the same individual.
Condition: Fair, probably a disturbed and redeposited cremation burial? 73.5% identified.
Determination of age: Epiphyses fused.
Determination of sex: Large ischium.
Identified elements: Small fragment of mandible, humerus, finger, pelvis, femur.
Measurements: Max skull frag size 25mm, max long bone frag size 56mm.
Colours: Cream.
Teeth: None.
Pathology: Nothing observed.

Layer L1 (find no 314): unsexed adult

Quantification: Total weight 8.0g: Skull 1.5g, lower limb 6.5g.
Description: Fragments from L1 in T28.
Condition: Fair. 100% identified.
Determination of age: Size.
Determination of sex: No sexing criteria.
Identified elements: Patella.
Measurements: Max skull frag size 22mm, max long bone frag size 30mm.
Colours: Cream.
Teeth: None.
Pathology: Nothing observed.

Layer L1 (find no 350): unsexed adult

Quantification: Total weight 98.0g: Skull 11.9g, axial 1.9g, upper limb 14.9g, lower limb 20.0g, unidentified 98.0g
Description: Fragments from L1 in T35.
Condition: Fair. 52.8% identified.
Determination of age: Size.
Determination of sex: No sexing criteria.
Identified elements: Distal radius, L vertebra.
Measurements: Max skull frag size 34mm, max long bone frag size 48mm.

Colours: Cream.
Teeth: - - - - / / / / | - - - - - - - -
- - - - - - - - | - - - - - - - -
Pathology: Distal radius has small exostosis above medial facet, possibly ossified haematoma? Large OPs vertebral body.

Layer L1 (find no 1007): unsexed adult

Quantification: Total weight 26.8g: Skull 4.5g, lower limb 4.8g, unidentified 17.5g. Animal 2.3g.
Description: Fragments from L1 in T89.
Condition: Fair. 34.7% identified.
Determination of age: Size.
Determination of sex: No sexing criteria.
Identified elements: Radius, L vert, femur.
Measurements: Max skull frag size 22mm, max long bone frag size 26mm.
Colours: Cream.
Teeth: None.
Pathology: Nothing observed.

Layer L2 (find no 6): unsexed adult

Quantification: Total weight 4.0g: Skull 4.0g.
Description: Topsoil.
Condition: Fair.
Determination of age: Size.
Determination of sex: No sexing criteria.
Identified elements: 1 skull fragment.
Measurements:
Colours: Cream.
Teeth: None.
Pathology: Nothing observed.

Layer L2 (find no 63): unsexed adult

Quantification: Total weight 5.9g: lower limb 5.9g.
Description: Topsoil.
Condition: Fair.
Determination of age: Size.
Determination of sex: No sexing criteria.
Identified elements: 2 frags femur.
Measurements:
Colours: Cream.

Teeth: None.
Pathology: Nothing observed.

Layer L16 (find no 354): unsexed adult

Quantification: Total weight 8.1g: unidentified 8.1g. Animal 0.5g.
Description: Subsoil.
Condition: Fair.
Determination of age: Size.
Determination of sex: No sexing criteria.
Identified elements: None.
Measurements: None.
Colours: Cream.
Teeth: None.
Pathology: Nothing observed.

Layer L23 (find no 377): unsexed adult

Quantification: Total weight 8.0g: Skull 0.5g, axial 2.3g, upper limb 5.2g. Animal 1.8g.
Description: Deposit.
Condition: Fair.
Determination of age: Size.
Determination of sex: No sexing criteria.
Identified elements: Vertebra, humerus.
Measurements:
Colours: Cream.
Teeth: None.
Pathology: Nothing observed.

Layer L36 (find no 1188): unknown

Quantification: Total weight 1.5g: unidentified 1.5g.
Description:
Condition: Poor, very small.
Determination of age: No ageing criteria.
Determination of sex: No sexing criteria.
Identified elements: None.
Measurements: None.
Colours: Cream.
Teeth: None.
Pathology: Nothing observed.

Layer L38 (find no 1011): unsexed adult

Quantification: Total weight 4.1g: lower limb 4.1g.
Description: Accumulation.
Condition: Fair.
Determination of age: Size.
Determination of sex: No sexing criteria.
Identified elements: Femur/tibia.
Measurements:
Colours: Cream.
Teeth: None.
Pathology: Nothing observed.

Layer L39/40 (find no 928): child?

Quantification: Total weight 0.6g: lower limb 0.6g.
Description: Deposit.
Condition: Fair.
Determination of age: Size.
Determination of sex: No sexing criteria.
Identified elements: 1 small frag femur?
Measurements:
Colours: Cream.
Teeth: None.
Pathology: Nothing observed.

Appendix 4: catalogue of inhumed human bone

by Sue Anderson

Notes

Methods of age and sex determination are generalised to give an idea of the bones used. Sexing based on the pelvis used more traits than entries might suggest. 'DF' stands for discriminant function, a statistical method of determining sex, where +2.0 is very male, -2.0 very female (WEA 1980).

Teeth are recorded in the form illustrated below.

| | | | |
|------------|-----------------|-----------------|----|
| Maxilla R. | 8 7 6 5 4 3 2 1 | 1 2 3 4 5 X 7 U | L. |
| Mandible | O 7 6 5 4 - - - | // 3 4 5 6 7 C | |
| | A C R | | |

| <u>Code</u> | <u>Meaning</u> |
|-------------|---|
| 1 2 3 etc. | Tooth present in jaw. |
| X | Tooth lost ante-mortem. |
| / | Tooth lost post-mortem. |
| U, u | Tooth unerupted. |
| O, o | Tooth in process of erupting. |
| C | Tooth congenitally absent. |
| - - - | Jaw missing. |
| A | Abscess present (above/below tooth number). |
| C | Caries present (above/below tooth number). |
| R | Root only. |

Lower case letters a-e and u/o are used for deciduous teeth. Attrition patterns are coded according to the scores suggested by Bouts and Pot (1989, modified version of Brothwell's original tooth wear chart).

A few abbreviations have been used in the catalogue for commonly occurring pathological conditions and anatomical regions. These are as follows:

| | | | |
|----|----------------------------|----|------------|
| OA | osteoarthritis | MT | metatarsal |
| OP | osteophytosis, osteophytes | MC | metacarpal |
| C | cervical) | L. | left |
| T | thoracic) vertebrae | R. | right |
| L | lumbar) | | |

Any other abbreviations should be self-explanatory, since they are simply shortened forms of bone names or anatomical areas (prox = proximal, etc.).

Tables of measurements for the skull and major long bones are included after the catalogue of disarticulated remains. Tables of non-metric trait scores are also provided.

Articulated skeletons

Grave 1, F1 Male, Young/Middle-aged.

Description: Fragments of skull, R. humerus and R. femur only.
 Condition: Poor, skull deformed post-mortem, very crumbly. Skull probably fairly complete, but no attempt made to reconstruct it. No bones of the face surviving. Surfaces lost.
 Determination of age: Lambdoid suture partially obliterated, tooth wear slight-moderate.
 Determination of sex: Very large occipital crests, prominent glabella/brow ridges, but mastoids medium.
 Stature: -
 Cranial index: -
 Teeth: -

| | | | | | | | | | | | | | | | |
|---|---|---|---|---|---|---|---|---|---|---|---|---|---|---|---|
| 8 | 7 | 6 | - | - | 3 | / | / | - | - | - | 4 | 5 | 6 | 7 | 8 |
| U | 7 | 6 | - | - | - | - | - | - | - | / | 4 | X | 6 | 7 | U |

Tooth wear: 1 2+ 4+ - - 4 - - - - - 4 3 4+ 2+ 1
 - 2+ 4+ - - - - - - - - 3 - 3+ 3- -

Dental pathology: None on surviving teeth.

Grave 2, F31 Male, Middle-aged/Old.

Description: Most of the skeleton was disarticulated in F39, only the lower R. leg and foot were in situ. Consequently the upper part of the body is fragmentary and most of the torso is missing. Fragments of all major limb bones, skull and pelvis are present. A few fragments of skull from F8 (79) also belong here.
 Condition: Fair, but most bones broken and incomplete.
 Determination of age: Some degeneration, cranial sutures partially obliterated.
 Determination of sex: Sciatic notch appears narrow, bones large and robust, occipital crests and mastoid process large.
 Stature: 166.4cm (5' 5½")
 Cranial index: -
 Teeth: None surviving.
 Pathology:
 Schmorl's nodes: Large in L2-4.
 Osteophytosis: OPs R. femur head and acetabulum. Large OPs distal ?L. MC1. Slight OP distal L. femur. L2-4, especially on L. side.
 Osteoarthritis: OA III (eburnation and very large OP) L. femur head, OA II superior L.

Infection: acetabulum.
Signs of pitting and striation on both parietals - probably healed inflammation, but could be porotic hyperostosis.
Periosteal graining and thickening both tibia shafts, mainly medially in superior half.
Lytic lesion in superior R. side of L2 body, resulting in partial collapse and wedging, but with new bone formation on the outer edge which probably strengthened the area. May have caused kyphosis. Possibly caused by TB.

Trauma: ?Osteochondritic pitting distal R. MT1 (7 x 5mm).
Large exostosis superior R. navicular above facet for 2nd cuneiform, probably due to torn muscle.

Miscellaneous: Skull very thick.

Grave 3, F40 ?Female, Adult.

Description: Fragments of pelvis, both femurs and a few finger bones.
Condition: Poor, fragmented.
Determination of age: Epiphyses fused, no degenerative changes at hips.
Determination of sex: Bones gracile, femoral head diameter 42mm.
Stature: -
Cranial index: -
Teeth: None.
Pathology:
Miscellaneous: Femoral neck angle appears abnormally oblique (Coxa valga).

Grave 4, F119 Male, Young/Middle-aged?

Description: Fairly complete skeleton, although bones of the torso are represented by fragments only, both hands missing.
Condition: Poor-fair, bones fairly complete, but all surfaces very eroded and bones are considerably narrower than they should be.
Determination of age: Epiphyses fused, cranial sutures still open, tooth wear slight-moderate, some degeneration.
Determination of sex: Cranium DF +1.9, Pelvis +2.0, bones large and robust.
Stature: 173.5cm (5' 8")
Cranial index: 81.0 (brachycranial)
Teeth:

| | | | | | | | | | | | | | | | | | |
|---|---|---|---|---|---|---|---|---|---|---|---|---|---|---|---|---|---|
| | | | C | C | C | | | | | | | | | | A | A | A |
| 8 | X | 6 | 5 | 4 | 3 | 2 | / | / | 2 | 3 | 4 | 5 | X | X | X | | |
| 8 | 7 | 6 | 5 | 4 | 3 | 2 | 1 | | 1 | 2 | 3 | 4 | 5 | 6 | 7 | 8 | |

Tooth wear: 3 - 7 3 7 3 2+ - - 2+ 3+ 3+ 4+ - - -

Dental pathology: 3 2- 3+ 3- 2+ 3 2+ 3- - 3 3 2+ 3- 3+ 3 3-
Caries advanced, interstitial in upper R. PM2. Upper R. M1 represented by one root only, mainly lost A-M.

Pathology:
Congenital anomalies: Sacralisation of L5 (only L. side survives)
Osteoarthritis: Vertebrae in poor condition but OA II in two mid-T verts L. zygapophyseal facets.
Infection: Periosteal new bone growth superior medial surface R. tibia. R. fibula in poor condition but shows very thick new bone growth, pitting and graining, especially at the superior end. Could be the result of a fracture, but difficult to be certain.

Trauma: Crush fracture L. talus with flattening and distortion of inferior large facet at the lateral edge, with a crack in the joint surface and a pitted area. Calcaneus does not seem to be affected.

Miscellaneous: Premature fusion of R. side of squamosal suture above mastoid process. Asymmetry of occipital bone, probably as a result of this, with greater growth on the R. side. May have caused a slight scoliosis?

Grave 5, F154 ?Male, Middle-aged/Old.

Description: Fragmented, but most bones represented by at least one piece, except the L. humerus and L. fibula. The skull was missing, but was thought to be the one excavated from F155, so this is included here.

Condition: Poor-fair, most bones fragmented and still in their soil matrix. Partial cleaning carried out during analysis. Skull fragmented, surface lost on L. side.

Determination of age: Tooth wear slight to moderate, but advanced a-m tooth loss. Some degeneration. Cranial sutures obliterated.

Determination of sex: Cranium DF +1.6, pelvis +1.6, bones medium.

Stature: 164.3cm (5' 5")

Cranial index: -

Teeth:

| | | | | | | | | | | | | | | | | |
|---|---|---|---|---|---|---|---|---|---|---|---|---|---|---|---|---|
| - | - | - | - | - | - | - | - | - | - | - | - | - | - | - | - | - |
| 8 | 7 | X | X | X | X | X | X | X | X | X | X | / | X | / | - | - |
| C | C | | | | | | | | | | | | | | | |

Tooth wear: - - - - - - - - - - - - - - - - - -
3- 3- - - - - - - - - - - - - - - - - -

Dental pathology: Caries occlusal and interstitial in lower R. M3, and interstitial cervical in lower R. M

Pathology:
Schmorl's nodes: T3-7, T10-L1, some large.
Osteophytosis: T11-12 (most not assessable). L. acetabulum.
Osteoarthritis: C3-4 bodies Grade II. Distal end R. radius slightly enlarged, especially to

anterior of joint, with OP and pitting peri-articularly, and new bone deposits and areas of very fine pitting on joint surface. Ulna may also be affected but is in poor condition. Arthritis of the wrist, could be post-traumatic?

Ankylosing spondylitis: Large DISH-like OP to R. side of T11-12.
Infection: Slight graining lateral R. tibia and medial L. tibia. R. fibula shaft has lumpy appearance, some enlargement, no pitting.
Trauma: Enlarged area c.¾ down shaft to medial side of linea aspera of L. femur with new bone growth, probably torn muscle attachment.
Miscellaneous: Skull very thick. Slight new bone growth (like HFI) on inner table of frontal bone. No evidence for Paget's Disease.

Grave 6, F158 Unsexed, Adult.

Description: A few fragmentary foot bones only.
Condition: Fair but fragmented and eroded.
Determination of age: Size of bones, epiphyses fused. No degenerative changes in joints.
Determination of sex: All diagnostic criteria lost.
Stature: -
Cranial index: -

Grave 7, F159 Unsexed, Young.

Description: Fragments of skull only.
Condition: Very poor and fragmented, surface erosion.
Determination of age: Cranial sutures open? Tooth wear slight.
Determination of sex: All diagnostic criteria lost.
Stature: -
Cranial index: -
Teeth:

| | | | | | | | | | | | | | | | | |
|---|---|---|---|---|---|---|---|--|---|---|---|---|---|---|---|---|
| - | - | 6 | - | - | 3 | 2 | - | | 1 | - | - | - | - | - | 7 | - |
| - | 7 | 6 | - | 4 | 3 | 2 | / | | 1 | - | - | - | - | - | 7 | - |

Tooth wear: - - 2- - - 2- 2- - 2+ - - - - - 2- -
- 2- 2+ - 2- 2 2+ - 3- - - - - 2- -

Dental pathology: Enamel hypoplasia c.2-5yrs.

Grave 8, F171 Male, approx 25-30.

Description: Near complete skeleton from the neck down.
Condition: Fair, but several bones have eroded surfaces.

Determination of age: Medial clavicle epiphyses partially fused.
 Determination of sex: Pelvis DF +1.2, bones large and robust.
 Stature: 171.3cm (5' 7½")
 Cranial index: -
 Teeth: None.
 Pathology:
 Congenital anomalies: Cleft S1 and S5. Noticeable asymmetry of L4-5 arches: L4 larger on L., L5 on R. Abnormal joints between naviculars and calcanea. T6-L2, especially large on T9-12.
 Schmorl's nodes: T6-L2, especially large on T9-12.
 Osteoarthritis: Slight pitting on abnormal joint between L. navicular and calcaneum.
 Trauma: Exostoses on both clavicles just lateral to insertion for costo-clavicular ligaments.
 Miscellaneous: Slight lateral bending of both tibia at superior third, probable genu valgum.

Grave 9 F208

?Female, Middle-aged/Old.

Description:

Fragmentary skeleton from probable disturbed burial. Consists of cranial vault fragments, mandible, lower halves of both humeri, upper right ulna, fragments of innominates, lower right femur, upper left femur and shaft, fragments of tibia shafts.

Condition:

Fair, but surfaces and long bone ends very eroded in places.

Determination of age:

Epiphyses fused, cranial sutures almost obliterated, tooth wear moderate.

Determination of sex:

Cranium DF +0.2, pelvis -1.4, long bones appear small and gracile, but erosion may have caused sexing criteria to appear smaller (or wider in the case of the sciatic notch?).

Stature:

-

Cranial index:

-

Teeth:

| | | | | | | | | | | | | | | | | |
|---|---|---|---|---|---|---|---|--|---|---|---|---|---|---|---|---|
| 8 | 7 | 6 | 5 | 4 | / | / | / | | 1 | 2 | 3 | / | X | 6 | 7 | 8 |
| | | | | | | | | | R | R | R | | A | R | | |

Tooth wear:

- - - - - / / / | - - - - - X - - - - -
 3 3+ 4+ - - - - - R R R A R 3+ 3

Dental pathology:

None observed, but several teeth survive as roots only due to post-mortem erosion.

Pathology:

Miscellaneous:

Slight new bone growth (probably HFI) on inner table of frontal bone.

Disarticulated remains

| | |
|---------------|--|
| F8 (79) | Fragments of skull = G2 (included with that skeleton). |
| F46 (184) | Fragments of large adult pair of tibiae and fibula shafts - probably one individual. |
| F155 | Fragments of skull = G5? (included with that skeleton). |
| T5 L2/L3 (8) | Fragments of distal R. femur and proximal tibia, and fragment of pelvis (acetabulum).
Epiphyseal lines still visible in cancellous bone, so probably young adult. |
| T8 L2 (85) | Small fragment of adult tibia or femur, possibly from G2/G3? |
| T33 L20 (310) | Abraded fragments of adult skull (mainly frontal and parietal). Large glabella suggests male. |
| T66 L36 (900) | Fragment of C1, ?skull fragment and piece of L. mandible (- - - - X / 8, abscess under M1), very abraded. Possibly from G8? |

Articulated skeletons: bones present (in black; disarticulated in green and red)



G1 (F1)



G2 (F31)/F9/F8



G3 (F40)



G4 (F119)



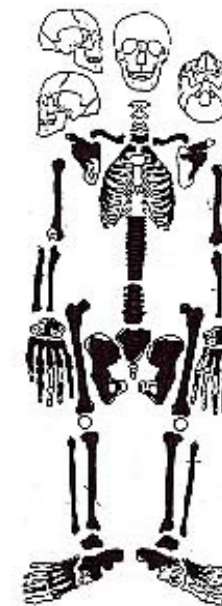
G5 (F154)/F155



G6 (F158)



G7 (F159)



G8 (F171)

Table 31: Cranial measurements of Grave 4 (F119).

| Cranium | | G4 |
|------------------------|-------------|-----------|
| Max Length | L | 195 |
| Max Breadth | B | 158 |
| Max Height | H' | 140 |
| Basi-nasal Length | LB | 107 |
| Basi-alveolar Length | GL | 100 |
| Upper facial Height | G'H | 76 |
| Bimaxillary Breadth | GB | 99 |
| Bizygomatic Breadth | J | |
| Nasal Height | NH' | |
| Nasal Breadth | NB | |
| Simotic Chord | SC | |
| Bi-dacryonic Chord | DC | |
| Orbital Breadth | O'1 | 36 |
| Orbital Height | O2 | |
| Palatal Length | G'1 | 47 |
| Palatal Breadth | G2 | 32 |
| Min Frontal Breadth | B' | 105 |
| Biasterionic Breadth | BiaStB | 115 |
| Foramen Magnum Length | FL | 37 |
| Foramen Magnum Breadth | FB | 34 |
| Frontal Arc | S1 | 132 |
| Parietal Arc | S2 | 128 |
| Occipital Arc | S3 | 126 |
| Frontal Chord | S'1 | 116 |
| Parietal Chord | S'2 | 119 |
| Occipital Chord | S'3 | 100 |
| Trans-Biporial Arc | B'Q | 331 |
| Mastoid Process Height | MPH | 32 |
| Cranial Index | 100(B/L) | 81.0 |
| Height/Length Index | 100(H'/L) | 71.8 |
| Height/Breadth Index | 100(H'/B) | 88.6 |
| Upper Facial Index | 100(G'H/J) | |
| Nasal Index | 100(NB/NH') | |
| Orbital Index | 100(O2/O'1) | |
| Palatal Index | 100(G2/G'1) | 68.1 |
| Foramen Magnum Index | 100(FB/FL) | 91.9 |
| Gnathic Index | 100(LB/GL) | 107.0 |

| Mandible | | |
|--------------------------|------|-----|
| Bicondylar Width | W1 | |
| Bigonial Breadth | GoGo | 115 |
| Foramen mentale Breadth | ZZ | 47 |
| Symphyseal Height | H1 | 33 |
| Mandibular Length | ML | 117 |
| Bicoronoid Breadth | CrCr | 105 |
| Minimum Ramus Breadth R | RB' | 32 |
| Minimum Ramus Breadth L | RB' | 31 |
| Coronoid Height R | CrH | |
| Coronoid Height L | CrH | |
| Condylar Length R | CyL | |
| Condylar Length L | CyL | |
| Gnathion-Gonion Length R | GnGo | |
| Gnathion-Gonion Length L | GnGo | 88 |

Table 32: Post-cranial measurements (G = Grave)

| | | | G2 | G3 | G4 | G5 | G8 |
|---|--------|---|------|-----|------|------|------|
| Femur | | | | | | | |
| Maximum length | FeL1 | R | | | | 431 | 456 |
| | | L | 441 | | 471 | 434 | 463 |
| Oblique length | FeL2 | R | | | | | 453 |
| | | L | 438 | | 469 | | 460 |
| Head diameter | FeHead | R | 48 | 42 | | | 46 |
| | | L | | | | 45 | 46 |
| Bicondylar breadth | FeE1 | R | | | | | |
| | | L | 84 | | | | 77 |
| Min subtrochanteric A-P diameter | FeD1 | R | 27 | 27 | | | 30 |
| | | L | 28 | | | 28 | 29 |
| Max subtrochanteric M-L diameter | FeD2 | R | 34 | 27 | | | 30 |
| | | L | 34 | | | 32 | 33 |
| Minimum shaft diameter (A-P) | FeD3 | R | 31 | | | | 31 |
| | | L | 29 | | | | 30 |
| Maximum shaft diameter (M-L) | FeD4 | R | 27 | | | | 28 |
| | | L | 28 | | | | 26 |
| Meric Index 100(FeD1/FeD2) | | R | 79.4 | 100 | | | 100 |
| | | L | 82.4 | | | 87.5 | 87.9 |
| Robusticity Index 100((FeD3+FeD4)/FeD2) | | R | | | | | 13.0 |
| | | L | 13.0 | | | | 12.2 |
| Tibia | | | | | | | |
| Maximum Length | TiL1 | R | | | | | |
| | | L | | | | | 368 |
| Bicondylar Breadth | TiE1 | R | | | | | |
| | | L | | | | | |
| A-P diameter at nutrient foramen | TiD1 | R | 31 | | | | |
| | | L | | | | | |
| M-L diameter at nutrient foramen | TiD2 | R | 25 | | | | |
| | | L | | | | | 26 |
| Cnemic Index 100(TiD2/TiD1) | | R | 80.6 | | | | |
| | | L | | | | | |
| Fibula | | | | | | | |
| Maximum Length | FiL1 | R | | | | | |
| | | L | | | | | 357 |
| Humerus | | | | | | | |
| Maximum Length | HuL1 | R | | | | | 331 |
| | | L | | | | | |
| Head diameter | HuHead | R | | | | | 48 |
| | | L | 46 | | | | |
| Epicondylar Breadth | HuE1 | R | | | | | |
| | | L | | | | | |
| Radius | | | | | | | |
| Maximum Length | RaL1 | R | | | | | 250 |
| | | L | | | | | |
| Ulna | | | | | | | |
| Maximum Length | UIL1 | R | | | | | 271 |
| | | L | | | | | |
| Calcaneus | | | | | | | |
| Maximum Length | CaL1 | R | | | | | |
| | | L | | | | | |
| Clavicle | | | | | | | |
| Maximum Length | CIL1 | R | | | | | 150 |
| | | L | | | | | |
| Stature | | | 1664 | | 1735 | 1643 | 1713 |

Table 33: Cranial non-metric traits

| | | G1 | G2 | G4 | G5 | G7 | G9 |
|--------------------------------|---|----|----|----|----|----|----|
| Highest nuchal line | R | 0 | 0 | 0 | + | - | 0 |
| | L | 0 | 0 | 0 | + | - | 0 |
| Ossicle at lambda/Inca | | 0 | ? | 0 | + | - | 0 |
| Lambdoid wormian bones | R | 0 | - | + | - | - | - |
| | L | - | - | 0 | - | - | - |
| Parietal foramen | R | 0 | + | + | - | - | + |
| | L | 0 | + | + | - | - | - |
| Bregmatic bone | | - | - | 0 | - | - | 0 |
| Metopism | | 0 | 0 | 0 | 0 | 0 | 0 |
| Coronal wormian bones | R | - | 0 | 0 | - | - | 0 |
| | L | - | 0 | 0 | - | - | - |
| Epipteric bone | R | - | - | 0 | - | - | - |
| | L | - | - | 0 | - | - | - |
| Fronto-temporal articulation | R | - | - | 0 | - | - | - |
| | L | - | - | 0 | - | - | - |
| Parietal notch bone | R | - | - | 0 | 0 | - | 0 |
| | L | - | - | 0 | - | - | 0 |
| Asterionic ossicle | R | - | - | 0 | - | - | - |
| | L | - | - | + | - | - | - |
| Auditory torus | R | 0 | - | 0 | 0 | - | 0 |
| | L | - | - | 0 | 0 | - | 0 |
| Huschke's foramen | R | 0 | - | 0 | 0 | - | 0 |
| | L | - | - | 0 | 0 | - | 0 |
| Post-condylar canal | R | - | - | + | - | - | - |
| | L | - | - | 0 | + | - | - |
| Double condylar facet | R | - | - | 0 | - | - | - |
| | L | - | - | 0 | - | - | - |
| Precondylar tubercle | R | - | - | + | - | - | - |
| | L | - | - | + | - | - | - |
| Double hypoglossal canal | R | - | - | 0 | + | - | - |
| | L | - | - | 0 | 0 | - | - |
| Foramen ovale incomplete | R | - | - | 0 | - | - | - |
| | L | - | - | 0 | - | - | - |
| Extra palatine foramen | R | - | - | 0 | - | - | - |
| | L | - | - | 0 | - | - | - |
| Palatine torus | R | - | - | 0 | - | - | - |
| | L | - | - | 0 | - | - | - |
| Maxillary torus | R | - | - | 0 | - | - | - |
| | L | - | - | 0 | - | - | - |
| Zygoma-facial foramen | R | - | - | 0 | - | - | - |
| | L | - | - | 0 | - | - | - |
| Supra-orbital foramen complete | R | 0 | - | 0 | - | - | 0 |
| | L | 0 | - | 0 | - | - | 0 |
| Extra infra-orbital foramen | R | - | - | - | - | - | - |
| | L | - | - | - | - | - | - |
| Sagittal wormian | | - | - | 0 | - | - | 0 |
| Squame parietal ossicle | R | - | - | 0 | - | - | - |
| | L | - | - | 0 | - | - | - |
| Multiple mental foramen | R | - | - | 0 | 0 | - | - |
| | L | - | - | 0 | - | - | - |
| Mandibular torus | R | 0 | - | 0 | 0 | - | 0 |
| | L | 0 | - | 0 | 0 | - | 0 |

Table 34: Post-cranial non-metric traits.

| | | G2 | G3 | G4 | G5 | G8 | G9 |
|--------------------------------|---|----|----|----|----|----|----|
| Atlas bridge lateral | R | - | - | - | - | - | - |
| | L | - | - | - | - | - | - |
| Atlas bridge posterior | R | - | - | - | - | - | - |
| | L | - | - | - | - | - | - |
| Atlas double facet | R | - | - | 0 | - | - | - |
| | L | - | - | 0 | - | - | - |
| Suprascapular foramen | R | - | - | - | - | 0 | - |
| | L | - | - | - | 0 | 0 | - |
| Sterno-manubrial fusion | R | - | - | - | - | - | - |
| | L | - | - | - | - | - | - |
| Septal aperture of humerus | R | - | - | - | - | - | - |
| | L | - | - | 0 | - | 0 | 0 |
| Epicondylar process of humerus | R | - | - | - | - | 0 | - |
| | L | - | - | 0 | - | 0 | - |
| Sacralisation of L5 | R | - | - | - | - | 0 | - |
| | L | - | - | + | - | 0 | - |
| Four sacral segments | | - | - | - | - | + | - |
| Six sacral segments | | - | - | - | - | - | + |
| Acetabular crease | R | 0 | + | - | 0 | 0 | 0 |
| | L | 0 | + | + | 0 | + | - |
| Allen's fossa of femur | R | 0 | - | - | - | 0 | - |
| | L | 0 | - | - | - | 0 | - |
| Poirier's facet of femur | R | + | - | - | - | + | - |
| | L | + | - | - | - | + | - |
| Plaque formation of femur | R | 0 | - | - | - | 0 | - |
| | L | 0 | - | - | - | 0 | - |
| Third femoral trochanter | R | 0 | - | - | 0 | + | - |
| | L | 0 | - | 0 | 0 | 0 | + |
| Vastus notch of patella | R | - | - | - | - | - | - |
| | L | 0 | - | - | - | - | - |
| Calcaneus double facet | R | + | - | 0 | - | ? | - |
| | L | - | - | 0 | - | ? | - |
| Cuboid-navicular articulation | R | + | - | 0 | - | + | - |
| | L | - | - | 0 | - | + | - |

Appendix 5: catalogue of all the animal bone

by Julie Curl

Table 35: Summary of all of the faunal remains. Listed in order of layer (L) number and then feature (F) number.

| Trench/
soakaway | Layer | Feature | Find No | Total Qty | Total Wt(g) | Species | Sp. Qty | Countable | Butchering | Ages | Burnt | Elements present/
Comments |
|---------------------|-------|---------|---------|-----------|-------------|----------------|---------|-----------|------------|--------|-------|-------------------------------------|
| 14 | 1 | | 154 | 5 | 43 | pig | 1 | | | mature | | large tusk |
| 14 | 1 | | 154 | | | mammal | 4 | | | | | |
| 18 | 1 | | 193 | 1 | 8 | mammal | 1 | | | | | |
| 19 | 1 | | 207 | 1 | 14 | cattle | 1 | | | | | molar |
| 20 | 1 | | 285 | 1 | 9 | mammal | 1 | | | | | poor condition,
surface |
| 21 | 1 | | 563 | 7 | 108 | cattle | 1 | 0.5 | chopped | adult | | proximal phalange |
| 28 | 1 | | 314 | 1 | 5 | mammal | 1 | | | | | |
| 29 | 1 | | 294 | 2 | 12 | mammal | 2 | | | | | |
| 34 | 1 | | 369 | 5 | 3 | mammal | 5 | | | | | |
| 34 | 1 | | 368 | 3 | 9 | mammal | 3 | | | | | |
| 34 | 1 | | 356 | 1 | 8 | cattle | 1 | | | adult | | premolar |
| 40 | 1 | | 335 | 1 | 3 | mammal | 1 | | | | | |
| 46 | 1 | | 437 | 1 | 5 | sheep/goat | 1 | | chopped | adult | | vertebrae fragment |
| 46 | 1 | | 437 | 4 | 43 | mammal | 4 | | | | | |
| 50 | 1 | | 367 | 1 | 21 | mammal | 1 | | | | | vertebrae fragment |
| 53 | 1 | | 460 | 2 | 14 | mammal | 2 | | | | | |
| 58 | 1 | | 701 | 1 | 7 | mammal | 1 | | | | | |
| 68 | 1 | | 852 | 4 | 84 | sheep/goat | 1 | 1 | chopped | adult | | goat metacarpal |
| 68 | 1 | | 852 | | | pig | 1 | 1 | chopped | adult | | humerus |
| 68 | 1 | | 852 | | | mammal | 2 | | | | | |
| 73 | 1 | | 904 | 1 | 19 | mammal | 1 | | | | | |
| 73 | 1 | | 904 | 5 | 33 | mammal | 5 | | butchered | | | |
| 73 | 1 | | 904 | 5 | 33 | mammal | 5 | | butchered | | | |
| 87 | 1 | | 1006 | 1 | 11 | cattle | 1 | | | | | metatarsal shaft
fragment |
| 8 | 2 | | 85 | 1 | 6 | sheep/
goat | 1 | | chopped | | | vertebrae fragment |
| 52 | 2 | | 130 | 2 | 15 | mammal | 2 | | | | | probably cattle |
| 56 | 2 | | 727 | 3 | 14 | mammal | 3 | | | | | |
| 113 | 2 | | 1170 | 16 | 200 | cattle | 6 | | | adult | | molars |
| 113 | 2 | | 1170 | | | mammal | 10 | | butchered | | | large mammal
prob.cattle |
| 124 | 2 | | 1193 | 1 | 11 | cattle | 1 | | chopped | | | metatarsal fragment |
| 124 | 2 | | 1193 | 1 | 12 | mammal | 1 | | | | | |
| 72 | 3 | | 926 | 3 | 48 | cattle | 1 | 0.5 | fine cuts | adult | | proximal phalange |
| 72 | 3 | | 926 | | | fox | 1 | 1 | | | | femur |
| 72 | 3 | | 926 | | | mammal | 1 | | chopped | | | |
| 113 | 3 | | 1171 | 1 | 102 | cattle | 1 | | chopped | adult | | radius fragment |
| 40 | 19 | | 317 | 2 | 64 | equid | 1 | 1 | chopped | adult | | metacarpal,
chopped mid-proximal |
| 40 | 19 | | 317 | | | mammal | 1 | | | | | |
| 33 | 20 | | 310 | 1 | 3 | mammal | 1 | | | | | |
| 45 | 30 | | 569 | 16 | 4 | bird | 16 | | | | | fragmentary,
very small pieces |
| 60 | 34 | | 729 | 1 | 25 | cattle | 1 | | chopped | adult | | vertebrae |

| Trench/
sackaway | Layer | Feature | Find No | Total Qty | Total Wt(g) | Species | Sp. Qty | Countable | Butchering | Ages | Burnt | Elements present/
Comments |
|---------------------|-------|------------|---------|-----------|-------------|-------------|---------|-----------|------------|----------|-------|--|
| 60 | 34 | | 729 | 1 | 3 | mammal | 1 | | | | | |
| 63 | 36 | | 848 | 6 | 43 | mammal | 6 | | butchered | | | |
| 66 | 36 | | 899 | 5 | 36 | equid | 1 | | | adult | | small pre-molar,
well worn, MULE |
| 66 | 36 | | 899 | | | mammal | 4 | | | | | fragments |
| 66 | 36 | | 1189 | 1 | 3 | mammal | 1 | | | | | |
| 66 | 36 | | 899 | 9 | 45 | mammal | 9 | | butchered | | | |
| 66 | 36 | | 899 | 2 | 18 | mammal | 2 | | butchered | | | large mammal frags,
probably cattle |
| 66 | 36 | | 899 | 6 | 90 | cattle | 1 | | | adult | | molar |
| 66 | 36 | | 899 | | | sheep/goat | 1 | 1 | chopped | mature | | mandible, goat |
| 66 | 36 | | 899 | | | mammal | 4 | | | | | |
| 85 | 38 | | 1001 | 1 | 13 | cattle | 1 | | sawn | | | part of distal
humerus, |
| 27 | 1,16 | | 362 | 1 | 20 | mammal | 1 | | | | | |
| 4 | | 12 | 47 | 1 | 7 | mammal | 1 | | chopped | | | |
| 11 | | 19 | 68 | 3 | 4 | pig | 3 | | | juvenile | | unerupted juvenile
molar & premolar |
| 9 | | 30 | 78 | 2 | 12 | sheep/goat | 2 | 1 | chopped | adult | | metatarsal, chopped
and split |
| 8 | | 31/G2 | 108 | 18 | 48 | mammal | 18 | | butchered | | | large mammal,
?cattle |
| 13 | | 34 | 91 | 1 | 14 | cattle | 1 | | chopped | | | neural spine from
vertebrae |
| 13 | | 34 | 86 | 5 | 24 | pig | 1 | 1 | chopped | adult | | humerus |
| 13 | | 34 | 86 | | | mammal | 4 | | | | | |
| 8 | | 39 | 105 | 8 | 60 | mammal | 8 | | chopped | | | rib and other frags |
| 8 | | 39 | 113 | 13 | 372 | cattle | 5 | 2.5 | butchered | adult | | pelvis, scapula,
phalange |
| 8 | | 39 | 113 | | | mammal | 9 | | butchered | | | |
| 8 | | 39 | 120 | 11 | 287 | human | 3 | 2 | | adult | | distal humerii
x 2, 1 x humerus
shaft |
| 8 | | 39 | 120 | | | cattle | 3 | 2 | chopped | adult | | metacarpal,
phalanges |
| 8 | | 39 | 120 | | | galliformes | 1 | 1 | | adult | | humerus |
| 8 | | 39 | 120 | | | mammal | 4 | | | | | |
| 101 | | 43 | 1039 | 4 | 7 | mammal | 4 | | | | | |
| 14 | | 46 | 184 | 8 | 45 | mammal | 8 | | | | | very poor condition,
eroded |
| 15 | | 47 | 517 | 1 | | rodent | 1 | | | | | no identification
possible |
| 51 | | 53 | 199 | 11 | 3 | mole | 11 | | | adult | | jaw, pelvis, skull
fragments, limb,
vertebra |
| 16 | | 63 | 301 | 2 | 21 | mammal | 2 | | | | | large mammal, ?cattle |
| 40 | | 72 | 334 | 3 | 5 | mammal | 3 | | | | | poor condition |
| 34 | | 80 | 355 | 2 | 1 | bird | 2 | | | | | shaft fragments |
| 24 | | 91 | 357 | 1 | 2 | mammal | 1 | | | | | |
| 49 | | 98 | 389 | 1 | 6 | mammal | 1 | | | | | poor condition, porous |
| 50 | | 110 | 641 | 3 | 43 | cattle | 1 | | chopped | adult | | calcaneus |
| 50 | | 110 | 641 | | | mammal | 2 | | chopped | | | |
| 50 | | 110 | 640 | 2 | 40 | cattle | 1 | | chopped | juv | | tibia fragment |
| 50 | | 110 | 640 | | | mammal | 1 | | | | | |
| 21 | | 119/
G4 | | 2 | 7 | mammal | 2 | | | | | |
| 54/45 | | 121 | 545 | 5 | 16 | cattle | 5 | | | | | molar frags, poor
condition |

| Trench/
saokaway
Layer | Feature | Find No | Total Qty | Total Wt(g) | Species | Sp. Qty | Countable | Butchering | Ages | Burnt | Elements present/
Comments |
|------------------------------|------------|---------|-----------|-------------|---------------|---------|-----------|-----------------|------------|-------|---------------------------------------|
| 21 | 125 | 674 | 2 | 62 | cattle | 2 | 1.5 | chopped | adult | | proximal metatarsal, distal phalange |
| 21 | 125 | 565 | 8 | 41 | cattle | 1 | | chopped | | | metacarpal fragment |
| 21 | 125 | 565 | | | sheep/goat | 1 | | chopped | adult | | radius fragment |
| 21 | 125 | 565 | | | mammal | 6 | | | | | |
| 39 | 128 | 671 | 1 | | fish-mackerel | 1 | | | | | vertebrae |
| 50 | 134 | 692 | 1 | 153 | cattle | 1 | 1 | cut/
chopped | adult | | metatarsals, probably Dexter, gnawed |
| 50 | 134 | 813 | 1 | | fish | 1 | | | | | vertebrae fragment, small species |
| 56 | 144 | 704 | 1 | 2 | mammal | 1 | | | | | |
| 56 | 144 | 704 | 2 | 115 | cattle | 1 | 1 | cut/chopped | adult | | talus |
| 56 | 144 | 704 | | | mammal | 1 | | | | | |
| 56 | 146 | 706 | 4 | 35 | equid | 4 | | | adult | | molar fragments |
| 56 | 146 | 706 | 6 | 14 | mammal | 6 | | | | | |
| 56 | 152 | 786 | 1 | 9 | mammal | 1 | | | | | |
| 63 | 162 | | 1 | | eel vertebra | 1 | | | | | |
| 63 | 162 | 895 | 1 | 162 | sheep/goat | 1 | | chopped | | white | metapodial fragment, burnt white |
| 73 | 166 | 905 | 2 | 18 | cattle | 2 | | chopped | | | metapodial fragments |
| 73 | 166 | 905 | 2 | 63 | sheep/goat | 1 | 1 | chopped | adult | | tibia |
| 73 | 166 | 905 | | | mammal | 1 | | chopped | | | rib, probably cattle |
| 73 | 166 | 905 | 9 | 103 | sheep/goat | 2 | 2 | chopped | adult | | tibias, both distal ends |
| 73 | 166 | 905 | | | mammal | 7 | | butchered | | | rib fragments, probably cattle |
| 73 | 166 | 905 | 4 | 53 | pig | 3 | 2.5 | chopped | juv/sub ad | | pelvis, unfused femur, phalange |
| 62 | 171/
G8 | 919 | 1 | 33 | equid | 1 | 1 | | juvenile | | femur head, unfused |
| 62 | 171/
G8 | 919 | 1 | 334 | equid | 1 | 1 | chopped | juv | | unfused femur, chopped distal shaft |
| 56 | 181 | 1105 | 2 | | fish | 2 | | | | | no identification possible |
| 99 | 193 | 1029 | | 1695 | cattle | 4 | 2 | butchered | adult | | humeri, femur, molar, |
| 99 | 193 | 1029 | | | sheep/goat | 1 | 1 | chopped | adult | | tibia |
| 99 | 193 | 1029 | | | pig | 1 | | chopped | adult | | humeri |
| 99 | 193 | 1029 | | | mammal | 25 | | butchered | | | large mammal frags, heavily butchered |
| 903 | 194 | 1052 | 4 | 20 | mammal | 4 | | | | | |
| 102 | 196 | 1053 | 6 | 39 | mammal | 6 | | | | | poor condition, surfaces |
| 108 | 199 | 1062 | 2 | 1 | rodent | 2 | | | adult | | femur, mouse species |
| Soaka | 202 | 1179 | 2 | 4 | mammal | 2 | | | | | |
| Soakv
11 | 205 | 1186 | 1 | 2 | mammal | 1 | | | | | |
| Soaka | 205 | 1187 | 39 | 977 | mammal | 37 | | butchered | | | large mammal, ?cattle |
| Soaka | 205 | 1187 | | | cattle | 2 | | cut/
chopped | juvenile | | unfused femur, chopped head |
| 66 | 207 | 1190 | 2 | 84 | mammal | 1 | | chopped | | | sacrum fragments |
| 120 | 208/
G | 1191 | 1 | 65 | cattle | 1 | 1 | chopped | adult | | metacarpal, distal end |
| Soaka | 42 | 133 | 1 | 2 | mammal | 1 | | | | | |

| Trench/
sackway
Layer | Feature | Find No | Total Qty | Total Wt(g) | Species | Sp. Qty | Countable | Butchering | Ages | Burnt | Elements present/
Comments |
|-----------------------------|---------|---------|-----------|-------------|---------|---------|-----------|------------|-------|-------|-------------------------------|
| 57 | U/s | 694 | 3 | 22 | mammal | 3 | | | | | |
| 65 | U/s | 885 | 1 | 17 | mammal | 1 | | | | | |
| 83 | U/s | 983 | 1 | 18 | cattle | 1 | | chopped | adult | | talus |

Appendix 6: tables of charred plant macrofossils and other environmental remains

by Val Fryer

Key to tables

x = 1-10 specimens
xx = 10-100 specimens
xxx = 100+ specimens
b = burnt
fg = fragment
CP = cremation pit
UF = urn fill
PF = pot fill
DF = dish fill
S = soil associated with bone

Table 36: charred plant macrofossils and other environmental remains from F12 and cremation burials F19, F36, F41, F83, F87, and F108

| Sample no | 177 | 55 | 68 | 94 | 129 | 140 | 345 | 395 | 584 |
|--------------------------------------|-------------|----------------|----------------|----------------|-------------|----------------|----------------|----------------|------------|
| Feature no | F12 | F19 | F19 | F36 | F41 | F41 | F83 | F87 | F108 |
| Cereals and other food plants | | | | | | | | | |
| Large Fabaceae indet. | x | | x | | | | | | |
| <i>Hordeum sp.</i> (grains) | | | | | | | | xcf | |
| <i>Vicia faba L.</i> | xcf | | | | | | | | |
| Cereal indet. (grains) | x | | x | | | | x | | |
| Herbs | | | | | | | | | |
| Fabaceae indet. | xx | | | | | | | x | x |
| <i>Medicago/Trifolium/Lotus sp.</i> | x | | | | | | | | |
| <i>Plantago lanceolata L.</i> | | | x | | | | | x | |
| <i>Polygonum aviculare L.</i> | | | x | | | | | | x |
| Polygonaceae indet. | | | | | x | | | | |
| <i>R. acetosella L.</i> | x | | | | | | | | |
| <i>Vicia/Lathyrus sp.</i> | | | x | | | | | | |
| Wetland plants | | | | | | | | | |
| <i>Eleocharis sp.</i> | | | | x | | | | | |
| <i>Montia fontana L.</i> | x | | | | | | | | |
| Tree/shrub macrofossils | | | | | | | | | |
| <i>Corylus avellana L.</i> | xcf | x | | | | | | | x |
| <i>Ulex europaeus L.</i> | x | | | | | | | | |
| Other plant macrofossils | | | | | | | | | |
| Charcoal <2mm | xxx | xx | xx | xxx | xx | xxx | xx | xx | xxx |
| Charcoal >2mm | | | x | x | | | | x | |
| Charred root/rhizome/stem | xx | x | xx | x | xx | x | x | | x |
| Indet fruit stone fragments | | | | | x | x | | | |
| Indet seeds | x | | | | | | | | |
| Other materials | | | | | | | | | |
| Black porous 'cokey' material | x | xx | xx | xx | xx | xx | xx | x | xxx |
| Black tarry material | | | | | x | xx | x | xx | x |
| Bone | x xb | xxb | xxb | x xxb | xb | x xxb | xb | xxb | x xb |
| Burnt/fired clay | x | | | x | xx | x | x | x | x |
| Burnt stone | | | | | | x | | | |
| Ferrous globules | | | x | x | | | | x | |
| Fish bone | | | | | | | x | | |
| Small coal fragments | x | x | xx | xx | xx | xx | xx | xx | xxx |
| Vitrified material | xxx | xx | xx | xx | x | x | | | |
| Sample volume (litres) | 10 | 10 | 18 | 18 | 30 | 18 | 10 | 20 | 70 |
| Volume of flot (litres) | 0.1 | <0.1 | <0.1 | <0.1 | 0.1 | <0.1 | <0.1 | <0.1 | 0.2 |
| % flot sorted | 100% | 100% | 100% | 100% | 100% | 100% | 100% | 100% | 50% |

Table 37: charred plant macrofossils and other environmental remains from cremation burials and possible pyre debris deposits F129, F133, F197, F199 and F203

| Sample no | 617 | 621 | 1067 | 1076 | 1062 | 1181 |
|--------------------------------------|-------------|----------------|-------------|------------|------------|----------------|
| Feature no | F129 | F133 | F197 | F197 | F199 | F203 |
| Cereals and other food plants | | | | | | |
| Large Fabaceae indet. | | | | | xfg | |
| Herbs | | | | | | |
| Fabaceae indet. | | | x | x | x | |
| <i>Galium aparine L.</i> | | | | x | | |
| <i>Medicago/Trifolium/Lotus sp.</i> | | | | | xcf | |
| <i>Polygonum aviculare L.</i> | | | | | | x |
| <i>Rumex sp.</i> | x | | | | | |
| Tree/shrub macrofossils | | | | | | |
| <i>Corylus avellana L.</i> | | x | | | | x |
| Other plant macrofossils | | | | | | |
| Charcoal <2mm | xx | xx | xxx | xx | xxx | xxx |
| Charcoal >2mm | xx | | xxx | xx | x | xx |
| Charred root/rhizome/stem | | x | | | x | xx |
| Indet seeds | | | | | x | |
| Other materials | | | | | | |
| Black porous 'cokey' material | xxx | xx | x | xx | x | x |
| Black tarry material | xx | x | x | x | x | x |
| Bone | xb | x xb | | xb | xxb | xxb |
| Burnt/fired clay | | | x | | | |
| Ferrous globules | | | x | | x | |
| Ferrous fragments | | | | | x | |
| Small coal fragments | xx | xx | x | xx | | x |
| Vitrified material | | | xxx | xxx | x | xxx |
| Sample volume (litres) | 20 | 10 | 70 | 60 | 52 | 20 |
| Volume of flot (litres) | 0.1 | <0.1 | 0.1 | 0.2 | 0.2 | <0.1 |
| % flot sorted | 100% | 100% | 100% | 50% | 50% | 100% |

Table 38: charred plant macrofossils and other environmental remains from cremation burial F42

| Sample no | 132 | 136 | | | | 137 | 150 | 152 | 153 | | | | 176 | 189 |
|--------------------------------------|-------------|----------------|----------------|----------------|----------------|----------------|-------------|----------------|----------------|----------------|----------------|----------------|----------------|----------------|
| Spit no | | 1 | 2 | 3 | 4 | | | | 1 | 2 | 3 | 4 | | |
| Context type | CP | UF | UF | UF | UF | FF | CP | CP | PF | PF | PF | PF | CP | CP |
| Cereals and other food plants | | | | | | | | | | | | | | |
| Large Fabaceae indet. | | | | | | | x | xxfg | | | | | | |
| <i>Triticum sp.</i> (grains) | xcf | | | | | | | | | | | | | |
| <i>Vicia faba L.</i> | xcf | | | | | | | xcf | | | | | | |
| Cereal indet. (grains) | | | | | | | xfg | | | | | | | |
| Herbs | | | | | | | | | | | | | | |
| Fabaceae indet. | x | | | x | | x | x | xx | | x | | | x | x |
| <i>Medicago/Trifolium/Lotus sp.</i> | | | | | | | | xcf | | | | | xcf | |
| Polygonaceae indet. | | | | | | | | | | | | | | x |
| <i>R. acetosella L.</i> | | | | | | | | x | | | | | | |
| <i>Vicia/Lathyrus sp.</i> | x | | | | | | | x | | | | | x | |
| Tree/shrub macrofossils | | | | | | | | | | | | | | |
| <i>Corylus avellana L.</i> | | | | | | | | | | | | | | x |
| <i>Cytisus scoparius (L.) Link</i> | | | | | | | | | | | | | | xcf |
| <i>Ulex europaeus L.</i> | x | | | x | | | x | xx | | | xcf | | xcf | xcf |
| Other plant macrofossils | | | | | | | | | | | | | | |
| Charcoal <2mm | xxx | x | x | xx | x | x | xxx | xxx | xx | x | x | x | xx | xx |
| Charcoal >2mm | x | | | | | | | | | | | | | |
| Charred root/rhizome/stem | x | | x | x | x | x | x | x | | | | | x | x |
| Indet seeds | x | | | | x | | x | x | | | | | x | |
| Other materials | | | | | | | | | | | | | | |
| Black porous 'cokey' material | xxx | x | | x | x | | xx | | | | | | xx | |
| Black tarry material | x | | x | | x | | | | | | | | | xx |
| Bone | xxb | xx | xb | x | x xb | | x xb | xxxb | | xb | | | | xxb |
| Burnt/fired clay | x | | | | | | x | | | | | | | x |
| Ferrous globules | x | | | | | | | | | | | | | |
| Small coal fragments | xx | | | | | | xx | | | | | | | x |
| Vitrified material | x | | | x | x | | xxx | xxx | | x | | | x | xx |
| Sample volume (litres) | 30 | 1 | 2 | 2 | 2 | 1 | 40 | 16 | 0.5 | 1 | 0.5 | 0.5 | 3 | 12 |
| Volume of flot (litres) | 0.1 | <0.1 | <0.1 | <0.1 | <0.1 | <0.1 | 0.1 | <0.1 | <0.1 | <0.1 | <0.1 | <0.1 | <0.1 | <0.1 |
| % flot sorted | 100% | 100% | 100% | 100% | 100% | 100% | 100% | 100% | 100% | 100% | 100% | 100% | 100% | 100% |

Table 39: charred plant macrofossils and other environmental remains from cremation burial F44

| Sample no | 617 | 621 | 1067 | 1076 | 1062 | 1181 |
|--------------------------------------|----------------|----------------|-------------|------------|------------|----------------|
| Feature no | F129 | F131 | F197 | F197 | F199 | F203 |
| Cereals and other food plants | | | | | | |
| Large Fabaceae indet. | | | | | xfg | |
| Herbs | | | | | | |
| Fabaceae indet. | | | x | x | x | |
| <i>Galium aparine</i> L. | | | | x | | |
| <i>Medicago/Trifolium/Lotus</i> sp. | | | | | xcf | |
| <i>Polygonum aviculare</i> L. | | | | | | x |
| <i>Rumex</i> sp. | x | | | | | |
| Tree/shrub macrofossils | | | | | | |
| <i>Corylus avellana</i> L. | | x | | | | x |
| Other plant macrofossils | | | | | | |
| Charcoal <2mm | xx | xx | xx | xx | xxx | xxx |
| Charcoal >2mm | xx | | xxx | xx | x | xx |
| Charred root/rhizome/stem | | x | | | x | x |
| Indet seeds | | | | | x | |
| Other materials | | | | | | |
| Black porous 'cokey' material | xxx | xx | x | xx | x | x |
| Black tarry material | xx | x | x | x | x | x |
| Bone | xb | x xb | | xb | xxb | xxb |
| Burnt/fired clay | | | x | | | |
| Ferrous globules | | | x | | x | |
| Ferrous fragments | | | | | x | |
| Small coal fragments | xx | xx | x | xx | | x |
| Vitrified material | | | xxx | xxx | x | xxx |
| Sample volume (litres) | 20 | 10 | 70 | 60 | 52 | 20 |
| Volume of flot (litres) | <0.1 | <0.1 | 0.1 | 0.2 | 0.2 | <0.1 |
| % flot sorted | 100% | 100% | 100% | 50% | 50% | 100% |

Table 40: charred plant macrofossils and other environmental remains from cremation burial F53

| Sample no | 199 | | | | | | | 208 | 223 | 224 | 240 | | 267 | 279 |
|--|----------------|----------------|-------------|----------------|----------------|----------------|----------------|----------------|----------------|------------|----------------|----------------|------------|----------------|
| Spit no | 1 | 2 | 3 | 4 | 5 | 6 | 7 | | | | 1 | 2 | | |
| Context type | UF | UF | UF | UF | UF | UF | UF | CP | CP | CP | DF | DF | CP | CP |
| Cereals and other food plants | | | | | | | | | | | | | | |
| Large Fabaceae indet. | | x | | | x | | | x | x | xx | xfg | xxfg | x | x |
| <i>Vicia faba</i> L. | | | | | | | | | xcf | xcf | | | xcf | |
| Cereal indet. (grains) | | | | | | | | xfg | | | | | | |
| Herbs | | | | | | | | | | | | | | |
| <i>Bromus</i> sp. | | | | | | | | | | x | | | | |
| Fabaceae indet. | x | xx | x | x | xx | xx | xx | xx | x | xxx | xx | xx | xxx | xx |
| <i>Fallopia convuvulus</i> (L.) A Love | | | | | | | | | | | x | | | |
| <i>Medicago/Trifolium/Lotus</i> sp. | | | | | | | | | | x | | | | |
| Small Poaceae indet. | | | | | | | | | | | x | | | |
| Polygonaceae indet. | x | | | | | | | | | | | | | |
| <i>Vicia/Lathyrus</i> sp. | | | | | | | | | | | | xcf | xcf | x |
| Wetland plants | | | | | | | | | | | | | | |
| <i>Montia fontana</i> L. | | | | | | | | | x | | | | | |
| Tree/shrub macrofossils | | | | | | | | | | | | | | |
| <i>Corylus avellana</i> L. | | | x | | | | x | x | | | | | | |
| <i>Ulex europaeus</i> L. | xcf | xcf | xcf | xcf | xcf | xcf | x | x | x | xx | x | x | xx | x |
| Other plant macrofossils | | | | | | | | | | | | | | |
| Charcoal <2mm | xx | x | x | xx | xx | xx | x | xx | xxx | xxx | x | x | xxx | xxx |
| Charcoal >2mm | x | x | | x | | | | xx | x | xxx | | | xxx | |
| Charred root/rhizome/stem | x | x | x | | x | x | x | x | x | x | x | x | x | x |
| Indet seeds | x | | | | x | | x | | | | x | | | |
| Indet tuber fragments | | | | | | | | x | | | | | | |
| Other materials | | | | | | | | | | | | | | |
| Black porous 'cokey' material | | x | x | x | | | x | x | | x | | x | | x |
| Black tarry material | | x | | | | | | xx | | | | x | x | |
| Bone | x xb | x xb | x xb | | | | x | xb | xb | xxb | xb | | xxb | xb |
| Burnt/fired clay | | | | | | | | x | | x | | | x | x |
| Ferrous globules | | | | | | | | | x | | | | | |
| Small coal fragments | | | | | | x | x | x | x | x | | x | x | x |
| Small mammal/amphibian bone | | | x | x | | x | x | | | | | | | |
| Vitrified material | | x | | x | | x | x | x | x | xx | x | | xx | xx |
| Sample volume (litres) | 2 | 3 | 2 | 2 | 2 | 2 | 3 | 60 | 3 | 52 | 2 | 1 | 34 | 10 |
| Volume of flot (litres) | <0.1 | <0.1 | 0.1 | <0.1 | <0.1 | <0.1 | <0.1 | <0.1 | <0.1 | 0.3 | <0.1 | <0.1 | 0.3 | <0.1 |
| % flot sorted | 100% | 100% | 100% | 100% | 100% | 100% | 100% | 100% | 100% | 50% | 100% | 100% | 50% | 100% |

Table 41: charred plant macrofossils and other environmental remains from F12 and cremation burials F115, F120, and F123

| Sample no | 497 | 498 | | | | | 601 | 606 | 636 |
|--------------------------------------|----------------|----------------|----------------|----------------|----------------|----------------|----------------|------------|------------|
| Feature no | F115 | F115 | F115 | F115 | F115 | F115 | F120 | F123 | F123 |
| Spit no | | 1 | 2 | 3 | 4 | 5 | | | |
| Context type | CP | UF | UF | UF | UF | UF | CP | CP | CP |
| Cereals and other food plants | | | | | | | | | |
| <i>Avena sp. (grains)</i> | xcf | | | | | | | | |
| Large Fabaceae indet. | | | | | | | | x | |
| <i>Triticum sp. (grains)</i> | xcf | | | | | | | | |
| Cereal indet. (grains) | | | | | | | | x | x |
| Herbs | | | | | | | | | |
| Fabaceae indet. | | | | | | | x | x | |
| Small Poaceae indet. | | x | x | | | | | | |
| <i>Polygonum aviculare L.</i> | | x | | | | | | | |
| Tree/shrub macrofossils | | | | | | | | | |
| <i>Corylus avellana L.</i> | xcf | | xcf | | | | | x | x |
| Other plant macrofossils | | | | | | | | | |
| Charcoal <2mm | xxx | xxx | xxx | x | xx | xx | xxx | xxx | xxx |
| Charcoal >2mm | | x | x | x | | | | xxx | xxx |
| Charred root/rhizome/stem | x | xx | xx | | | | | x | x |
| Indet fruit stone fragments | x | | | | | | | | |
| Indet seeds | | x | | | | | x | | |
| Indet tuber fragments | | | | | | | | | x |
| Other materials | | | | | | | | | |
| Black porous 'cokey' material | xx | | x | | | | | x | x |
| Black tarry material | x | | | | | | x | x | |
| Bone | xb | xb | xb | xb | xxb | xxb | xxxb | xxb | xb |
| Burnt/fired clay | | | | | | | | x | |
| Copper alloy residues | | | | | | | x | | |
| Ferrous globules | | | | | | | x | | x |
| Mineralised concretions | | | | | | | x | | |
| Mineral-replaced textiles | | | | | | | xx | | |
| Mineral-replaced wood | | | | | | | xx | | |
| Small coal fragments | x | | | | | | x | x | |
| Vitrified material | x | x | x | x | x | x | x | x | |
| Sample volume (litres) | 25 | 2 | 2 | 2 | 2 | 1 | 20 | 20 | 10 |
| Volume of flot (litres) | <0.1 | <0.1 | <0.1 | <0.1 | <0.1 | <0.1 | <0.1 | 0.3 | 0.2 |
| % flot sorted | 100% | 100% | 100% | 100% | 100% | 100% | 100% | 50% | 50% |

Table 42: charred plant macrofossils and other environmental remains from cremation burial F141

| Sample no | 981 | | | | | | | | | | | | 1003 |
|--------------------------------------|----------------|----------------|----------------|----------------|----------------|----------------|----------------|----------------|----------------|----------------|----------------|----------------|----------------|
| Spit no | 1 | 2 | 3 | 4 | 5 | 6 | 7 | 8 | 9 | 10 | 11 | 12 | |
| Context type | UF | UF | UF | UF | UF | UF | UF | UF | UF | UF | UF | UF | CP |
| Cereals and other food plants | | | | | | | | | | | | | |
| Large Fabaceae indet. | | | | | | | | | xfg | | | | |
| <i>Hordeum sp.</i> (grains) | | | | | | | | | | | | | xcf |
| Cereal indet. (grains) | | | | | | | | | x | | | | |
| Herbs | | | | | | | | | | | | | |
| Fabaceae indet. | | | | | x | x | x | x | x | | x | x | xx |
| <i>Vicia/Lathyrus sp.</i> | | x | | | | | | | | | | | |
| Tree/shrub macrofossils | | | | | | | | | | | | | |
| <i>Ulex europaeus L.</i> | | | | | | | | | | | xcf | | x |
| Other plant macrofossils | | | | | | | | | | | | | |
| Charcoal <2mm | xx | xxx | x | x | xx | x | xxx | xx | xx | xx | xx | xx | xxx |
| Charcoal >2mm | | | | | | x | | | x | x | x | x | xxx |
| Charred root/rhizome/stem | | | | | x | x | | | x | | | | x |
| Other materials | | | | | | | | | | | | | |
| Black porous 'cokey' material | xx | | x | x | x | | | x | x | x | | x | xx |
| Black tarry material | | | | x | x | x | x | x | | x | x | x | x |
| Bone | xb | x | xb | | xb | x | xb | xb | x xb | x xb | | | xb |
| Burnt/fired clay | x | | | | | | x | | | | | | x |
| Ferrous globules | | x | | | | | | | | | | | |
| Fish bone | | | | | | | x | | | | | | |
| Small coal fragments | | x | | | | | | | | | x | | x |
| Vitrified material | | | x | | x | x | | x | x | x | | | x |
| Sample volume (litres) | 1 | 1 | 2 | 2 | 2 | 2 | 2 | 2 | 2 | 2 | 2 | 3 | 118 |
| Volume of flot (litres) | <0.1 | <0.1 | <0.1 | <0.1 | <0.1 | <0.1 | <0.1 | <0.1 | <0.1 | <0.1 | <0.1 | <0.1 | 1.3 |
| % flot sorted | 100% | 100% | 100% | 100% | 100% | 100% | 100% | 100% | 100% | 100% | 100% | 100% | <10% |

Table 43: charred plant macrofossils and other environmental remains from cremation burial F142

| Sample no | 722 | 725 | | | | | | | | | 795 | 796 |
|--------------------------------------|----------------|----------------|----------------|----------------|----------------|----------------|----------------|----------------|----------------|----------------|------------|------------|
| Spit no | | 1 | 2 | 3 | 4 | 5 | 6 | 7 | 8 | 9 | | |
| Context type | S | UF | UF | UF | UF | UF | UF | UF | UF | UF | CP | CP |
| Cereals and other food plants | | | | | | | | | | | | |
| <i>Avena sp.</i> (grains) | | | | | | | | | | | x | |
| Large Fabaceae indet. | | | | x | | x | | x | | | xxxxfg | xx |
| <i>Vicia faba L.</i> | | | | | | | | | | | xcf | xcoty |
| Herbs | | | | | | | | | | | | |
| Fabaceae indet. | x | | x | x | x | x | x | x | x | x | xxxfg | x |
| Small Poaceae indet. | | | | | | | | | x | | | |
| <i>R. acetosella L.</i> | | | | | | x | | | | | | x |
| <i>Vicia/Lathyrus sp.</i> | xcf | | | | | | | | | | | |
| Other plant macrofossils | | | | | | | | | | | | |
| Charcoal <2mm | x | x | xx | xx | xx | xx | xx | xx | xx | xx | xxx | xxx |
| Charcoal >2mm | x | x | xx | x | x | x | | x | x | | xxx | xxx |
| Charred root/rhizome/stem | x | x | x | x | x | x | x | x | | x | xxx | xx |
| Indet seeds | | | | x | | | | | | | | x |
| Other materials | | | | | | | | | | | | |
| Black porous 'cokey' material | | x | | | | | | | x | x | | x |
| Black tarry material | | | | | | | | x | x | x | | |
| Bone | xb | xb | xb | xb | | xb | xxb | xxb | xxb | xb | xxb | x xxb |
| Burnt/fired clay | | | | | | | | x | | | | |
| Burnt stone | | x | | | | | | | | | | |
| Glass fragments | | | | | | | | x | | | | |
| Vitrified material | | x | | | | x | | x | x | x | x | x |
| Sample volume (litres) | 0.5 | 2 | 2 | 2 | 2 | 1 | 2 | 2 | 2 | 2 | 56 | 74 |
| Volume of flot (litres) | <0.1 | <0.1 | <0.1 | <0.1 | <0.1 | <0.1 | <0.1 | <0.1 | <0.1 | <0.1 | 0.4 | 0.5 |
| % flot sorted | 100% | 100% | 100% | 100% | 100% | 100% | 100% | 100% | 100% | 100% | 25% | 25% |

Table 44: charred plant macrofossils and other environmental remains from cremation burials F162, and F178

| Sample no | 854 | 881 | 884 | 920 | | | 994 |
|--------------------------------------|----------------|----------------|------------|----------------|----------------|----------------|------------|
| Feature no | F162 | F162 | F162 | F178 | F178 | F178 | F178 |
| Spit no | | | | 1 | 2 | 3 | |
| Context type | CP | CP | CP | UF | UF | UF | CP |
| Cereals and other food plants | | | | | | | |
| Cereal indet. (grains) | x | | x | | | | |
| Herbs | | | | | | | |
| Fabaceae indet. | | | | | x | | |
| Polygonaceae indet. | | x | | | | | |
| Tree/shrub macrofossils | | | | | | | |
| <i>Corylus avellana</i> L. | x | | x | xcf | | | x |
| <i>Ulex europaeus</i> L. | | | x | | | | |
| Other plant macrofossils | | | | | | | |
| Charcoal <2mm | xx | xx | xxx | xxx | xx | x | xxx |
| Charcoal >2mm | xx | | xx | x | | | xxx |
| Charred root/rhizome/stem | x | | | | | | x |
| Indet seeds | x | | x | | | | |
| Other materials | | | | | | | |
| Black porous 'cokey' material | x | x | xx | | x | | |
| Black tarry material | x | x | x | | | | xx |
| Bone | x xb | | xb | x | xb | xb | xxb |
| Burnt/fired clay | | | | | | | x |
| Ferrous globules | x | | | | | | |
| Fish bone | x | | x | | | | |
| Small coal fragments | xx | x | xx | | | | x |
| Vitrified material | x | x | xx | x | x | x | xx |
| Sample volume (litres) | 30 | 10 | 100 | 3 | 2 | 2 | 40 |
| Volume of flot (litres) | <0.1 | <0.1 | 0.2 | <0.1 | <0.1 | <0.1 | 0.2 |
| % flot sorted | 100% | 100% | 50% | 100% | 100% | 100% | 50% |

Table 45: charred plant macrofossils and other environmental remains from cremation burial F180

| Sample no | 930 | | | | | | | 933 |
|---------------------------------|----------------|----------------|----------------|----------------|----------------|----------------|----------------|----------------|
| Spit no | 1 | 2 | 3 | 4 | 5 | 6 | 7 | |
| Context type | UF | UF | UF | UF | UF | UF | UF | CP |
| Herbs | | | | | | | | |
| Fabaceae indet. | | | | x | | | | x |
| <i>Veronica hederifolia</i> L. | | | | | x | | | |
| Other plant macrofossils | | | | | | | | |
| Charcoal <2mm | x | x | xx | xx | x | xx | x | xx |
| Charred root/rhizome/stem | | | | | x | | | x |
| Other materials | | | | | | | | |
| Black porous 'cokey' material | x | | x | | | | | xx |
| Black tarry material | | | | | | x | | xx |
| Bone | x xb | x | x | x | xb | xb | xb | xxb |
| Burnt/fired clay | | | x | | | | | xx |
| Ferrous fragments | | | | | | | | x |
| Vitrified material | x | | | x | x | | | xx |
| Sample volume (litres) | 2 | 1 | 2 | 2 | 2 | 2 | 2 | 30 |
| Volume of flot (litres) | <0.1 | <0.1 | <0.1 | <0.1 | <0.1 | <0.1 | <0.1 | <0.1 |
| % flot sorted | 100% | 100% | 100% | 100% | 100% | 100% | 100% | 100% |

Table 46: charred plant macrofossils and other environmental remains from cremation burials F182, and F186

| Sample no | 972 | 998 | | | | | | 999 |
|--------------------------------------|------------|----------------|----------------|----------------|----------------|----------------|----------------|-------------|
| Feature no | F182 | F186 | F186 | F186 | F186 | F186 | F186 | F186 |
| Spit no | | 1 | 2 | 3 | 4 | 5 | 6 | |
| Context type | CP | UF | UF | UF | UF | UF | UF | CP |
| Cereals and other food plants | | | | | | | | |
| <i>Hordeum sp. (grains)</i> | | | | | | xcf | | |
| Herbs | | | | | | | | |
| <i>Bromus sp.</i> | x | | | | | | | |
| Fabaceae indet. | x | | x | | | | | x |
| Tree/shrub macrofossils | | | | | | | | |
| <i>Ulex europaeus L.</i> | | | | | | | | xcf |
| Other plant macrofossils | | | | | | | | |
| Charcoal <2mm | xx | x | xx | xx | xx | x | | xxx |
| Charcoal >2mm | xx | | | | | | | xx |
| Charred root/rhizome/stem | x | | | | | | | x |
| Indet seeds | | | | | | | | x |
| Other materials | | | | | | | | |
| Black porous 'cokey' material | xx | x | | | | | x | |
| Black tarry material | xx | x | x | x | | | x | x |
| Bone | xxb | | | | xb | xxb | xxb | xxb |
| Burnt/fired clay | x | | x | | | | x | x |
| Ferrous globules | x | | | | | | | |
| Small coal fragments | xx | x | | | x | x | x | x |
| Vitrified material | xx | | | | | | | x |
| Sample volume (litres) | 40 | 2 | 2 | 2 | 2 | 2 | 2 | 32 |
| Volume of flot (litres) | 0.2 | <0.1 | <0.1 | <0.1 | <0.1 | <0.1 | <0.1 | 0.1 |
| % flot sorted | 50% | 100% | 100% | 100% | 100% | 100% | 100% | 100% |

Table 47: charred plant macrofossils and other environmental remains from cremation burial F15

| Sample no | 47 | | | | | | | | |
|---------------------------------|----------------|----------------|----------------|----------------|----------------|----------------|----------------|----------------|----------------|
| Spit no | 1 | 2 | 3 | 4 | 5 | 6 | 7 | 8 | 9 |
| Cereals | | | | | | | | | |
| <i>Avena sp. (grains)</i> | | x | | | | | | | |
| Herbs | | | | | | | | | |
| Small Poaceae indet. | | | | | | | | x | |
| <i>Rumex sp.</i> | | | | | | | | x | |
| Other plant macrofossils | | | | | | | | | |
| Charcoal <2mm | xx | xxx | xx | xx | xx | xx | xx | xx | xx |
| Charcoal >2mm | | | | x | | | | | |
| Other materials | | | | | | | | | |
| Black porous 'cokey' material | | x | xx | | xx | | x | x | xx |
| Black tarry material | x | x | x | x | | xx | x | | xx |
| Bone | xb | x | x | x xb | xx | xb | x xb | x xb | xb |
| Burnt/fired clay | x | | x | | | | | | |
| Small coal fragments | x | x | | | x | x | x | | xx |
| Vitrified material | | | | | | x | x | | |
| Sample volume (litres) | 1 | 2 | 2 | 2 | 2 | 2 | 2 | 2 | 2 |
| Volume of flot (litres) | <0.1 | <0.1 | <0.1 | <0.1 | <0.1 | <0.1 | <0.1 | <0.1 | <0.1 |
| % flot sorted | 100% | 100% | 100% | 100% | 100% | 100% | 100% | 100% | 100% |

Table 48: charred plant macrofossils and other environmental remains from cremation burials F103, and F165

| Sample no | 458 | | | | | | | 871 | | |
|---------------------------------|----------------|----------------|----------------|----------------|----------------|----------------|----------------|----------------|----------------|----------------|
| Feature no | F103 | | | | | | | F165 | | |
| Spit no | 1 | 2 | 3 | 4 | 5 | 6 | 7 | 1 | 2 | 3 |
| Cereals | | | | | | | | | | |
| <i>Hordeum sp.</i> (grains) | | | x | | | | | | | |
| <i>Triticum sp.</i> (grains) | | | | | | | | | | x |
| Herbs | | | | | | | | | | |
| <i>Vicia/Lathyrus sp.</i> | | | | | | | xcf | | | |
| Other plant macrofossils | | | | | | | | | | |
| Charcoal <2mm | xx | xx | xx | x | xx | x | x | xx | xx | xx |
| Charcoal >2mm | | | | | | | | x | | x |
| Charred root/rhizome/stem | x | | | | | x | | | | x |
| Mineral-replaced wood | | | | | | | | x | | |
| Indet seeds | | | | | | | | x | | |
| Other materials | | | | | | | | | | |
| Black porous 'cokey' material | x | xx | | | | x | | x | | x |
| Black tarry material | | | x | | | | x | | | |
| Bone | xb | xb | xb | xx | x | x xb | xb | xb | xb | xb |
| Burnt/fired clay | | | | | | x | | | | |
| Small coal fragments | | | | | | | x | | | |
| Small mammal/amphibian bone | | | | | | | | | x | |
| Vitrified material | | | x | | | x | | | x | x |
| Sample volume (litres) | 1 | 2 | 2 | 2 | 2 | 2 | 2 | 2 | 2 | 3 |
| Volume of flot (litres) | <0.1 | <0.1 | <0.1 | <0.1 | <0.1 | <0.1 | <0.1 | <0.1 | <0.1 | <0.1 |
| % flot sorted | 100% | 100% | 100% | 100% | 100% | 100% | 100% | 100% | 100% | 100% |

Table 49: charred plant macrofossils and other environmental remains from cremation burials F179, and F192

| Sample no | 936 | | | 1034 | | | | | | |
|---------------------------------|----------------|----------------|----------------|----------------|----------------|----------------|----------------|----------------|----------------|----------------|
| | F179 | | | F192 | | | | | | |
| Spit no | 1 | 2 | 3 | 1 | 2 | 3 | 4 | 5 | 6 | 7 |
| Cereals | | | | | | | | | | |
| <i>Hordeum sp. (grains)</i> | | | | | | | | | | xcf |
| Cereal indet (grains) | | | | | | | | | x | |
| Tree/shrub macrofossils | | | | | | | | | | |
| <i>Corylus avellana L.</i> | | | x | | | | | | | |
| Other plant macrofossils | | | | | | | | | | |
| Charcoal <2mm | xx | x | x | x | x | xx | xx | x | x | xx |
| Charcoal >2mm | x | | | | | x | x | | | |
| Charred root/rhizome/stem | | x | x | | | | | | | |
| Indet seeds | | | x | | | | | | | |
| Other materials | | | | | | | | | | |
| Black porous 'cokey' material | x | | x | | x | | x | | | x |
| Black tarry material | x | x | xx | x | | x | | | | x |
| Bone | | xb | xb | xb | xb | xb | xb | xb | xb | xb |
| Burnt/fired clay | | | | x | x | | x | | | |
| Ferrous globules | | | | x | | | | | | |
| Metallic residues | | x | | | x | | | | | |
| Small coal fragments | | | | x | | | | | | |
| Vitrified material | x | x | x | | | x | | | | |
| Sample volume (litres) | 2 | 3 | 2 | 2 | 2 | 2 | 3 | 1 | 2 | 2 |
| Volume of flot (litres) | <0.1 | <0.1 | <0.1 | <0.1 | <0.1 | <0.1 | <0.1 | <0.1 | <0.1 | <0.1 |
| % flot sorted | 100% | 100% | 100% | 100% | 100% | 100% | 100% | 100% | 100% | 100% |

Table 50: charred plant macrofossils and other environmental remains from cremation burial F181

| Sample no | 1105 | | | | | | | | | | | | |
|---------------------------------|----------------|----------------|----------------|----------------|----------------|----------------|----------------|----------------|----------------|----------------|----------------|----------------|----------------|
| Spit no | 1 | 2 | 3 | 4 | 5 | 6 | 7 | 8 | 9 | 10 | 11 | 12 | 13 |
| Cereals | | | | | | | | | | | | | |
| <i>Triticum sp. (grains)</i> | | x | | | | | | | | | | x | |
| Cereal indet. (grains) | | | | | | | x | | | | | x | |
| Herbs | | | | | | | | | | | | | |
| <i>Polygonum aviculare L.</i> | | | | | | | | | x | | | | |
| Other plant macrofossils | | | | | | | | | | | | | |
| Charcoal <2mm | xx | xx | xx | x | x | xx | xx | xx | x | x | x | xx | xx |
| Charcoal >2mm | x | x | | | | | x | x | | | x | x | x |
| Charred root/rhizome/stem | | | | | | | x | x | | x | | x | |
| Other materials | | | | | | | | | | | | | |
| Black porous 'cokey' material | x | x | | x | x | | x | x | x | x | | x | |
| Black tarry material | x | x | x | x | | | | | x | x | x | x | |
| Bone | | | | | xb | xxb | | xb | | | x xxb | | xb |
| Small coal fragments | x | | x | | x | | | xx | x | x | x | | |
| Vitrified material | x | | | x | | | | | | | | | |
| Sample volume (litres) | 2 | 1 | 2 | 3 | 1 | 2 | 4 | 4 | 3 | 3 | 2 | 2 | 2 |
| Volume of flot (litres) | <0.1 | <0.1 | <0.1 | <0.1 | <0.1 | <0.1 | <0.1 | <0.1 | <0.1 | <0.1 | <0.1 | <0.1 | <0.1 |
| % flot sorted | 100% | 100% | 100% | 100% | 100% | 100% | 100% | 100% | 100% | 100% | 100% | 100% | 100% |

Table 51: charred plant macrofossils and other environmental remains from cremation burial F198

| Sample no | 1078 | | | | | | | | | |
|-------------------------------------|----------------|----------------|----------------|----------------|----------------|----------------|----------------|----------------|----------------|----------------|
| Spit no | 1 | 2 | 3 | 4 | 5 | 6 | 7 | 8 | 9 | 10 |
| Cereals | | | | | | | | | | |
| <i>Avena sp.</i>
(grains) | | | | | xcf | | | | | |
| Herbs | | | | | | | | | | |
| Fabaceae
indet. | | | x | | | | | | | |
| Other plant
macrofossils | | | | | | | | | | |
| Charcoal
<2mm | xx | x | xx | xx | xcf | x | x | x | x | x |
| Charcoal
>2mm | | | | x | | | | | | |
| Charred root/
rhizome/stem | | | | | | | | x | | |
| Other
materials | | | | | | | | | | |
| Black tarry
material | | x | | x | x | x | | x | x | x |
| Bone | | | xb | xb | xb | xb | xxb | xb | xb | xb |
| Burnt/fired clay | | | x | | | | | | | |
| Small coal
fragments | | | | | | | | | x | x |
| Sample vol
(litres) | 3 | 3 | 3 | 3 | 3 | 3 | 3 | 3 | 2 | 3 |
| Flot vol
(litres) | <0.1 | <0.1 | <0.1 | <0.1 | <0.1 | <0.1 | <0.1 | <0.1 | <0.1 | <0.1 |
| % flot sorted | 100% | 100% | 100% | 100% | 100% | 100% | 100% | 100% | 100% | 100% |

Table 52: charred plant macrofossils and other environmental remains from bustum F47

| Sample no | 205 | 244 | 245 | 246 | 298 | 514 | 515 | 516 | 517 |
|---|-------------|----------------|----------------|----------------|----------------|----------------|----------------|------------|------------|
| Cereals and other food plants | | | | | | | | | |
| <i>Hordeum sp.</i>
(grains) | | | | | | x | | | |
| <i>Triticum sp.</i>
(grains) | | | | | | xcf | | | |
| Cereal indet.
(grains) | | | | | | x | | x | x |
| Herbs | | | | | | | | | |
| <i>Fallopia convolvulus</i>
(L.)A.Love | | | | x | | | | | |
| <i>R. Acetosella L.</i> | | x | | | | | | | |
| <i>Vicia/Lathyrus sp.</i> | | x | | | | | | | |
| Wetland plants | | | | | | | | | |
| <i>Carex sp.</i> | | x | | | | | | | |
| Tree/shrub macrofossils | | | | | | | | | |
| <i>Corylus avellana L.</i> | xcf | | | | | x | | | x |
| Other plant macrofossils | | | | | | | | | |
| Charcoal <2mm | xxx | xxx | xxx | xxx | xx | xxx | xxx | xxx | xxx |
| Charcoal >2mm | xx | xxx | xx | x | | x | x | xx | xx |
| Charred root/rhizome/stem | x | | | | | x | x | x | x |
| Other materials | | | | | | | | | |
| Black porous 'cokey' material | x | x | xx | x | xx | xxx | xx | xx | x |
| Black tarry material | x | xx | xxx | x | | x | xx | x | x |
| Bone | xxb | xxb | xb | xxb | xb | xxxb | xb | xxb | xb |
| Burnt/fired clay | x | x | | x | | x | | | |
| Burnt stone | | | x | | | | x | | |
| Copper alloy residues | | | | x | | | | | |
| Ferrous globules | | | | | | x | | x | |
| Glass fragments | | | | | | | | x | |
| Small coal fragments | xx | x | x | xx | | xx | xx | xx | x |
| Vitrified material | | x | | x | | | x | x | x |
| Sample volume (litres) | 52 | 10 | 10 | 20 | 1 | 30 | 20 | 28 | 36 |
| Volume of flot (litres) | 0.1 | <0.1 | <0.1 | <0.1 | <0.1 | <0.1 | <0.1 | 0.3 | 0.2 |
| % flot sorted | 100% | 100% | 100% | 100% | 100% | 100% | 100% | 50% | 50% |

Table 53: charred plant macrofossils and other environmental remains from bustum F134

| Sample no | 691 | 692 | 693 | 811 | 813 | 814 |
|---|------------|----------------|----------------|----------------|------------|-------------|
| Cereals and other food plants | | | | | | |
| <i>Malus/Pyrus sp.</i> | | | | | x | |
| <i>Prunus sp.</i> (fruits stone fragment) | | | | | | x |
| Cereal indet. (grains) | x | | | | | |
| Herbs | | | | | | |
| Fabaceae indet. | x | x | x | | x | x |
| Tree/shrub macrofossils | | | | | | |
| <i>Corylus avellana L.</i> | | | | | x | |
| <i>Ulex europaeus L.</i> | | x | | | x | |
| Other plant macrofossils | | | | | | |
| Charcoal <2mm | xxx | xxx | xxx | xxx | xxx | xxx |
| Charcoal >2mm | xxx | xxx | xxx | xx | xx | xx |
| Charred root/rhizome/stem | x | | | | | |
| Indet seeds | | | | | x | |
| Other materials | | | | | | |
| Black porous 'cokey' material | xx | xx | x | x | x | x |
| Black tarry material | xxx | x | x | x | x | x |
| Bone | xxb | xxb | xb | xb | xxb | xxb |
| Burnt/fired clay | x | x | x | | | |
| Burnt stone | | | | | x | x |
| Copper alloy residues | | | x | | | |
| Ferrous globules | | | | | x | |
| Ferrous fragments | x | x | | | x | x |
| Ferrous nails/studs | | | | | | x |
| Fish bone | x | | | | | |
| Small coal fragments | x | x | x | x | x | x |
| Vitrified material | x | x | x | | x | x |
| Sample volume (litres) | 60 | 10 | 32 | 6 | 90 | 10 |
| Volume of flot (litres) | 0.2 | <0.1 | <0.1 | <0.1 | 0.3 | 0.1 |
| % flot sorted | 50% | 100% | 100% | 100% | 50% | 100% |

Table 54: samples containing only charcoal or charred root/stem and other materials

| Sample no | Feature no | Spit no | Context type | Contents |
|-----------|------------|---------|--------------|--|
| 128 | 41 | 1 | UF | CH;BPC;BL.TAR MAT;B;VIT MAT |
| | | 2 | UF | CH;B;SM.COAL;VIT MAT |
| | | 3 | UF | CH;CR/R/ST;BL.TAR MAT;B,SM COAL,VIT MAT |
| | | 4 | UF | CH;CR/R/ST;BPC;B;B/FC;VIT MAT |
| | | 5 | UF | CH;BL.TAR MAT;B;B/FC |
| 148 | 42 | | PF | CH;CR/R/ST;B |
| 175 | 45 | | CP | CH;CR/R/ST;BPC;BL TAR MAT; B; FE GLOB ,SM COAL |
| 290 | 59 | | S | CH;CR/R/ST;BPC;BLTAR MAT; SM COAL |
| 393 | 87 | | S | CH;SM.COAL;VIT MAT |
| 431 | 87 | 1 | UF | CH;BPC;BL.TAR MAT |
| | | 2 | UF | CH;BPC;B |
| | | 3 | UF | CH;BL.TAR MAT |
| | | 4 | UF | CH;BL.TAR MAT; VIT MAT |
| | | 5 | UF | CH;BL.TAR MAT |
| | | 6 | UF | CH;BPC;SM.COAL |
| | | 7 | UF | CH;BPC;B |
| | | 8 | UF | CH;BPC;SM.COAL |
| | | 9 | UF | CH;BPC;B;B/FC;SM.COAL |
| 430 | 102 | 1 | UF | CH;CR/R/ST;B;BL.TAR MAT |
| | | 2 | UF | CH;BPC;BL.TAR MAT |
| | | 3 | UF | CH;BPC;B;SM.COAL |
| | | 4 | UF | CH;BPC;BL.TAR MAT |
| | | 5 | UF | CH;CR/R/ST |
| | | 6 | UF | CH;CR/R/ST;BL.TAR MAT ;B |
| | | 7 | UF | CH;BPC;BL.TAR MAT |
| 487 | 108 | 1 | UF | CH |
| | | 2 | UF | CH |
| | | 3 | UF | CH;BPC;B |
| 542 | 114 | 1 | UF | CH;BPC |
| | | 2 | UF | CH;BPC |
| | | 3 | UF | CH |
| | | 4 | UF | CH;B;SM.COAL |
| | | 5 | UF | CH;BPC;B;SM.COAL |
| | | 6 | UF | CH;BPC |
| | | 7 | UF | CH |
| | | 8 | UF | CH;BPC;B;B/FC |
| | | 9 | UF | CH;BPC;B;SM.COAL |
| | | 10 | UF | CH;BPC |
| | | 11 | UF | CH;BPC;SM.COAL |
| | | 12 | UF | CH;BPC;B |
| | | 13 | UF | BPC; SM.COAL; VIT MAT |
| | | 14 | UF | CH;BPC;B;SM.COAL |
| | | 15 | UF | CH;BPC;B |
| 686 | 118 | | UF | CH;BPC;B |
| 551 | 120 | 1 | PF | CH |
| | | 2 | PF | CH |
| | | 3 | PF | CH;B |
| | | 4 | PF | CH |
| | | 5 | PF | CH;B |
| | | 6 | PF | CH;BPC;B |
| 600 | 120 | | S | CH;B |
| 566 | 126 | 1 | | CH;B |
| | | 2 | | CH;B |

| Sample no | Feature no | Spit no | Context type | Contents |
|-----------|------------|---------|--------------|--|
| | | 3 | | CH;B;B/FC |
| 671 | 128 | 1 | UF | CH;B;B/FC |
| | | 2 | UF | CH;B |
| | | 3 | UF | CH;B |
| | | 4 | UF | CH;B;B/FC |
| | | 5 | UF | CH;B;B/FC |
| | | 6 | UF | CH;B |
| | | 7 | UF | CH;BPC;B |
| | | 8 | UF | CH;BPC;B |
| | | 9 | UF | CH;BPC;B |
| | | 10 | UF | CH;BPC;B/FC |
| | | 11 | UF | CH;B |
| 628 | 129 | | S | CH;B |
| 633 | 129 | | CP | CH;BPC;B;SM.COAL |
| 846 | 134 | | S | CH;B;B/FC |
| 688 | 135 | 1 | UF | CH;BPC;B |
| | | 2 | UF | CH;B/FC;?POT;SM.COAL |
| | | 3 | UF | CH;BPC |
| | | 4 | UF | CH;BPC;B |
| | | 5 | UF | CH;BPC;B |
| | | 6 | UF | CH;B |
| | | 7 | UF | CH;BPC;B;SM.COAL |
| | | 8 | UF | CH;B |
| | | 9 | UF | CH;BPC;B |
| | | 10 | UF | CH;BPC;B;SM.COAL |
| | | 11 | UF | CH;BPC |
| 1083 | 137 | 1 | BF | CH;BPC;B |
| | | 2 | BF | CH;BPC;BL.TAR MAT ;B;SM COAL |
| | | 3 | BF | CH;CR/R/ST;BPC;BL.TAR MAT ,GLASS,VIT MAT |
| 1084 | 137 | 1 | UF | CH;B/FC;VIT MAT |
| | | 2 | UF | CH |
| | | 3 | UF | CH |
| | | 4 | UF | CH;B |
| | | 5 | UF | CH;B |
| | | 6 | UF | CH;B |
| | | 7 | UF | CH;B |
| 1085 | 137 | | FLAG | CH;B/FC |
| 1086 | 137 | | S | CH |
| 0865 | 162 | | | CH |
| 0859 | 165 | 1 | UF | CH;BPC;B/FC |
| | | 2 | UF | CH |
| | | 3 | UF | CH;BPC |
| | | 4 | UF | CH;B |
| | | 5 | UF | CH;BPC;B |
| 0935 | 179 | 1 | FLAG | CH;BL.TAR MAT; B |
| | | 2 | FLAG | CH;BPC;BL.TAR MAT;SM COAL |
| 0930 | 180 | | POT 1 | CH;BPC;B; VIT MAT |
| 0930 | 180 | | POT 2 | CH;B |
| 0971 | 182 | | S | CH;B;VIT MAT |
| 1033 | 192 | 1 | UF | CH |
| | | 2 | UF | CH;BPC;B |
| 1050 | 195 | 1 | UF | CH;BL.TAR MAT;B |
| | | 2 | UF | CH;BL.TAR MAT;B |
| | | 3 | UF | CH;BL.TAR MAT;B |
| | | 4 | UF | CH;BL.TAR MAT;B |
| | | 5 | UF | CH |
| | | 6 | UF | CH;B; B/FC |
| | | 7 | UF | CH;BPC; BL.TAR MAT ;B |
| 1051 | 195 | 1 | BF | CH;BL.TAR MAT ;B/FC |
| | | 2 | BF | CH; BPC; B; VIT MAT |

| Sample no | Feature no | Spit no | Context type | Contents |
|-----------|------------|---------|--------------|--|
| 1066 | 199 | 3 | BF | CH; BPC; VIT MAT |
| | | 1 | UF | CH;B/FC |
| | | 2 | UF | CH;BL.TAR MAT ;B |
| | | 3 | UF | CH;BL.TAR MAT ;B |
| | | 4 | UF | CH;CR/R/ST;BPC;BL.TAR MAT ;B;
BFC;SM.COAL |
| 1168 | 200 | 1 | | CH |
| | | 2 | | CH;BPC |
| | | 3 | | CH;BPC;BL.TAR MAT ;B |
| | | 4 | | CH;CR/R/ST;BRACKEN PINNULE FRAG;B |
| | | 5 | | CH;BL.TAR MAT ;B |
| | | 6 | | CH;BL.TAR MAT ;B |
| | | 7 | | CH;CR/R/ST;BL.TAR MAT ;B |
| | | 8 | | CH;BL.TAR MAT ;B |
| 1177 | 201 | 1 | | CH |
| | | 2 | | CH |
| | | 3 | | CH |
| | | 4 | | CH;B |
| | | 5 | | CH; BL.TAR MAT ;B |
| | | 6 | | CH; BL.TAR MAT ;B |
| | | 7 | | CH; BL.TAR MAT ;B;B/FC; SM COAL |
| 1178 | | 1 | | CH |
| | | 2 | | CH |
| | | 3 | | CH |
| | | 4 | | CH |
| | | 5 | | CH |
| 350 | | | S | CH;BL.TAR MAT ;B |
| 351 | | | S | CH;CR/R/ST;BPC;BL.TAR MAT ;B;FE GLOB;
SM COAL,VIT MAT |

Key for Table 54.

CH = charcoal
CR/R/ST = charred root/rhizome/stem
BPC = black porous 'cokey' material
BL TAR MAT = black tarry material
B = bone
B/FC = burnt/fired clay
FE GLOB = ferrous globule
SM COAL = small coal fragments
VIT MAT = vitrified material
UF = um fill
CP = cremation pit
S = soil associated with bone
PF = pot fill
BF = bowl fill
FLAG = flagon fill

Appendix 7: catalogues of medieval and post-medieval pottery

by Howard Brooks

Description of pottery

Fabrics present are as follows (after Cunningham 1985 and Cotter 2000): fabrics 13 (early medieval ware); 20 (early medieval ware); 21 (sandy orange ware); 21a (Colchester-type ware); 22 (Hedingham ware); 35 (Mill Green ware); 40 (post-medieval red earthenware); 40bl (black glazed fabric 40); 42 (Surrey-Hampshire white ware - "Border Ware"); 45 (unspecified stoneware); 45c (Raeren stoneware); 45d (Frechen stoneware); 45f (Westerwald stoneware); 45m (English stoneware); 46 (tin-glazed earthenware); 48b (English porcelain); 48d (modern ironstone); 48e (Yellow ware); 50 (Staffordshire slipware); 51a (late slipped kitchenware); and 51b (flowerpot). Pottery weights are listed below in tables 1 and 2 (unidentified fabrics are not listed). Full details in archive.

T = trench, S = soakaway, +R = plus residual earlier material

Table 55: weight of medieval fabric types per find number and context (stratified material only).

| Find n | Trench | Con-text | Fabrics | | | | | | context date (some bags have later material) |
|--------|---------|---------------|---------|-----|-----|-----|----|----|--|
| | | | 13 | 20 | 21 | 21a | 22 | 35 | |
| 0011 | T2 | F4 | 4 | 0 | 0 | 0 | 0 | 0 | 19-20th century +R |
| 0014 | T2 | F4 | 4 | 0 | 0 | 0 | 0 | 0 | 19-20th century +R |
| 0042 | T9 | F14 | 0 | 0 | 4 | 0 | 0 | 0 | 13th-16th century |
| 0121 | T8 | F39 | 0 | 33 | 0 | 0 | 0 | 0 | late 13th-14th century |
| 0341 | T27 | F85 | 0 | 0 | 24 | 0 | 0 | 0 | 19-20th century +R |
| 0386 | T27 | F91 | 19 | 0 | 0 | 0 | 0 | 0 | 17th-18th century +R |
| 0413 | T56 | F100 | 0 | 16 | 0 | 0 | 0 | 0 | 13th + Roman |
| 0641 | T50? | F110? | 6 | 0 | 0 | 0 | 0 | 0 | 12th century |
| 0795 | T58 | F142 | 0 | 0 | 0 | 1 | 0 | 0 | 14th? |
| 0786 | T56 | F152 | 0 | 0 | 12 | 0 | 0 | 0 | 13th-16th century |
| 0300 | T25 | L1 | 4 | 0 | 0 | 0 | 0 | 0 | 12th century |
| 0306 | T20 | L1 | 0 | 11 | 0 | 0 | 0 | 0 | 17th-18th +R |
| 0313 | T28 | L1 | 8 | 0 | 6 | 0 | 0 | 0 | 17th-18th +R |
| 0332 | T34 | L1 | 0 | 0 | 0 | 8 | 0 | 0 | 19th-20th +R |
| 0339 | T35 | L1 | 11 | 0 | 0 | 0 | 0 | 0 | 12th century |
| 0349 | T48 | L1 | 0 | 10 | 0 | 0 | 0 | 0 | 19th-20th century +R |
| 0356 | T34 | L1 | 0 | 10 | 0 | 0 | 0 | 0 | 19th-20th century +R |
| 0373 | T38/T37 | L1 | 0 | 12 | 5 | 0 | 0 | 0 | 17th-18th century +R |
| 0728 | T39 | L1 | 0 | 0 | 66 | 0 | 0 | 0 | 13th-16th century |
| 0852 | T68 | L1 | 0 | 0 | 15 | 0 | 0 | 0 | 20th century +R |
| 0440 | T54 | L1 | 0 | 0 | 0 | 0 | 0 | 36 | late 13th possibly 14th century |
| 0904 | T73 | L1 | 0 | 0 | 14 | 0 | 0 | 0 | 19th-20th century +R |
| 0927 | T74 | L1 | 0 | 3 | 0 | 0 | 0 | 0 | 19th-20th century +R |
| 1013 | T84 | L1 | 22 | 0 | 0 | 0 | 0 | 0 | 12th century |
| 1022 | T96 | L1 | 14 | 0 | 0 | 0 | 0 | 0 | 12th century |
| 0888 | T67 | L1? | 12 | 0 | 15 | 0 | 0 | 0 | 19th-20th century +R |
| 0021 | T5 | L2 | 0 | 0 | 0 | 14 | 0 | 0 | 19th-20th century +R |
| 0142 | S3 | L11 | 17 | 0 | 0 | 0 | 7 | 0 | 17th century +R |
| 0400 | T56 | L28 | 6 | 0 | 0 | 0 | 0 | 0 | 12th century |
| 0406 | T51 | L28 | 2 | 0 | 0 | 0 | 0 | 0 | 12th century |
| 0603 | T38 | L28 | 12 | 0 | 0 | 0 | 0 | 0 | 12th century |
| 1061 | T108 | L41 | 0 | 0 | 6 | 0 | 0 | 0 | 13th-16th century |
| | | totals | 154 | 115 | 188 | 44 | 29 | 71 | 601 |

Table 56: weight of post-medieval fabric types per find number and context (stratified material only).

| Find n | Trench | Cont-ext | fabrics | | | | | | | | | | | | | | | context date | |
|--------|--------|----------|---------|-----|----|----|-----|-----|-----|-----|----|-----|-----|-----|----|-----|-----|---------------------------------------|-----------------------|
| | | | 40 | 40a | 42 | 45 | 45c | 45d | 45f | 45m | 46 | 48b | 48d | 48e | 50 | 51a | 51b | | |
| 3 | | F1 | 0 | 0 | 0 | 0 | 0 | 0 | 0 | 0 | 0 | 0 | 0 | 0 | 0 | 8 | 0 | 0 | 1680-1750 |
| 885 | T65 | | 5 | 0 | 0 | 0 | 0 | 0 | 0 | 0 | 0 | 0 | 0 | 0 | 0 | 0 | 0 | 0 | 17th-18 th |
| 977 | T90 | | 0 | 0 | 0 | 0 | 0 | 0 | 0 | 0 | 0 | 0 | 0 | 0 | 0 | 36 | 7 | 19 th -20 th | |
| 11 | T2 | F4 | 0 | 0 | 0 | 0 | 0 | 0 | 0 | 0 | 0 | 0 | 0 | 0 | 0 | 0 | 14 | 19 th -20 th +R | |
| 14 | T2 | F4 | 4 | 0 | 0 | 0 | 0 | 0 | 0 | 0 | 0 | 0 | 6 | 0 | 0 | 0 | 0 | 19 th -20 th | |
| 96 | | F8 | 36 | 0 | 0 | 0 | 0 | 0 | 0 | 0 | 0 | 0 | 3 | 0 | 0 | 0 | 0 | 19 th -20 th | |
| 26 | T5 | F9 | 0 | 0 | 0 | 22 | 0 | 0 | 0 | 0 | 0 | 0 | 0 | 0 | 0 | 0 | 0 | 16 th ? | |
| 33 | T3 | F11 | 8 | 0 | 0 | 0 | 0 | 0 | 0 | 0 | 0 | 18 | 0 | 0 | 0 | 0 | 0 | 19 th -20 th | |
| 78 | T9 | F30 | 16 | 0 | 0 | 0 | 0 | 0 | 0 | 0 | 0 | 4 | 0 | 0 | 0 | 0 | 0 | 19 th -20 th | |
| 89 | T13 | F35 | 4 | 0 | 0 | 0 | 0 | 0 | 0 | 0 | 0 | 6 | 0 | 0 | 0 | 0 | 0 | 19 th -20 th | |
| 112 | T8 | F39 | 0 | 64 | 0 | 0 | 0 | 0 | 0 | 0 | 0 | 0 | 0 | 0 | 0 | 0 | 0 | 1600-1750 | |
| 170 | T17 | F45 | 24 | 0 | 0 | 0 | 0 | 0 | 0 | 0 | 0 | 0 | 0 | 0 | 0 | 0 | 0 | 17th-18 th | |
| 192 | T18 | F52 | 0 | 0 | 0 | 0 | 0 | 0 | 0 | 30 | 0 | 0 | 0 | 0 | 0 | 0 | 0 | 19 th -20 th | |
| 235 | T20 | F58 | 15 | 0 | 0 | 0 | 0 | 0 | 0 | 0 | 0 | 4 | 0 | 0 | 0 | 0 | 0 | 19th 20 th | |
| 301 | T16 | F63 | 28 | 0 | 0 | 0 | 0 | 0 | 0 | 0 | 0 | 0 | 0 | 0 | 0 | 0 | 0 | 17th-18 th | |
| 384 | T32 | F68 | 0 | 0 | 0 | 0 | 0 | 0 | 0 | 0 | 0 | 7 | 0 | 0 | 0 | 0 | 0 | 19 th -20 th | |
| 364 | T27 | F74 | 8 | 0 | 0 | 0 | 0 | 0 | 0 | 3 | 0 | 0 | 0 | 0 | 0 | 0 | 0 | 20 th | |
| 330 | T31 | F76 | 0 | 0 | 0 | 0 | 0 | 0 | 0 | 0 | 0 | 6 | 0 | 0 | 0 | 0 | 0 | 19 th -20 th | |
| 331 | T31 | F77 | 0 | 0 | 0 | 0 | 0 | 0 | 0 | 0 | 0 | 3 | 0 | 0 | 0 | 0 | 0 | 19 th -20 th | |
| 341 | T27 | F85 | 32 | 0 | 0 | 0 | 0 | 0 | 0 | 0 | 0 | 2 | 0 | 0 | 0 | 0 | 0 | 19th-20th +R | |
| 357 | T24 | F91 | 21 | 0 | 0 | 0 | 0 | 0 | 0 | 0 | 0 | 0 | 0 | 0 | 0 | 0 | 0 | 19 th -20 th | |
| 358 | T26 | F91 | 22 | 0 | 0 | 0 | 0 | 5 | 0 | 0 | 0 | 6 | 0 | 3 | 0 | 0 | 0 | 19 th -20th +R | |
| 386 | T27 | F91 | 11 | 0 | 0 | 4 | 0 | 0 | 0 | 0 | 0 | 0 | 0 | 0 | 0 | 0 | 0 | 17th-18th +R | |
| 547 | T47 | F106 | 0 | 0 | 0 | 0 | 0 | 0 | 0 | 0 | 0 | 6 | 0 | 0 | 0 | 0 | 0 | 19 th -20 th | |
| 680 | T45 | F137 | 0 | 0 | 0 | 0 | 0 | 0 | 0 | 0 | 0 | 2 | 0 | 0 | 0 | 0 | 0 | 19th-20 th | |
| 704 | T56 | F144 | 0 | 0 | 0 | 0 | 0 | 11 | 0 | 7 | 0 | 1 | 0 | 0 | 0 | 0 | 0 | 17th-18 th | |
| 889 | T59 | F150 | 0 | 0 | 0 | 0 | 0 | 0 | 0 | 11 | 0 | 106 | 0 | 0 | 0 | 0 | 0 | 19 th -20 th +R | |
| 891 | T61 | F150 | 0 | 0 | 0 | 0 | 0 | 0 | 0 | 0 | 0 | 2 | 0 | 0 | 0 | 0 | 0 | 19 th -20 th | |
| 892 | T60 | F150 | 0 | 0 | 0 | 0 | 0 | 0 | 0 | 0 | 0 | 24 | 0 | 0 | 0 | 14 | 0 | 19 th -20 th | |
| 913 | T59/T6 | F150 | 0 | 0 | 0 | 0 | 0 | 0 | 0 | 0 | 0 | 27 | 0 | 0 | 0 | 0 | 0 | 19 th -20 th | |
| 794 | T60 | F151 | 0 | 0 | 0 | 0 | 0 | 0 | 0 | 19 | 0 | 0 | 0 | 0 | 0 | 0 | 0 | 19 th -20 th | |
| 860 | T68 | F165 | 0 | 0 | 0 | 0 | 0 | 0 | 0 | 44 | 0 | 0 | 0 | 0 | 0 | 0 | 0 | 19 th -20 th | |
| 905 | T73 | F166 | 64 | 0 | 0 | 0 | 0 | 0 | 0 | 44 | 0 | 10 | 675 | 0 | 0 | 35 | 0 | 19th-20 th +R | |
| 896 | T72 | F170 | 0 | 0 | 0 | 9 | 0 | 10 | 0 | 0 | 0 | 0 | 0 | 0 | 0 | 0 | 0 | late 16th-17th | |
| 924 | T72 | F176 | 0 | 0 | 0 | 1 | 0 | 0 | 0 | 0 | 0 | 0 | 0 | 0 | 0 | 0 | 0 | 16th-18 th | |
| 1009 | T88 | F189 | 11 | 0 | 0 | 0 | 0 | 0 | 0 | 0 | 0 | 0 | 0 | 0 | 0 | 0 | 0 | 17 th | |
| 1182 | | F204 | 12 | 0 | 0 | 0 | 0 | 0 | 0 | 0 | 0 | 10 | 0 | 0 | 10 | 0 | 0 | 19 th -20 th | |
| 131 | S1 | L1 | 0 | 0 | 0 | 0 | 0 | 0 | 0 | 55 | 0 | 0 | 34 | 0 | 0 | 0 | 0 | 19 th -20 th | |
| 193 | T18 | L1 | 0 | 0 | 0 | 0 | 0 | 0 | 0 | 0 | 0 | 0 | 0 | 0 | 0 | 0 | 20 | 19 th -20 th | |
| 221 | T21 | L1 | 0 | 0 | 7 | 0 | 0 | 0 | 0 | 0 | 0 | 22 | 0 | 0 | 0 | 0 | 0 | 19th-20th +R | |
| 271 | T23 | L1 | 9 | 0 | 0 | 2 | 0 | 0 | 0 | 0 | 0 | 4 | 0 | 0 | 0 | 0 | 0 | 19th +R | |
| 272 | T23 | L1 | 0 | 0 | 0 | 0 | 0 | 0 | 0 | 0 | 0 | 6 | 0 | 0 | 0 | 0 | 0 | 19 th -20 th | |
| 285 | T20 | L1 | 16 | 0 | 0 | 0 | 0 | 0 | 0 | 0 | 0 | 0 | 0 | 0 | 0 | 0 | 2 | 17th-20 th | |
| 293 | T30 | L1 | 11 | 0 | 0 | 0 | 0 | 10 | 0 | 0 | 0 | 19 | 0 | 25 | 0 | 0 | 0 | 19th-20th +R | |
| 294 | T29 | L1 | 4 | 0 | 0 | 6 | 0 | 0 | 0 | 0 | 3 | 2 | 9 | 0 | 0 | 12 | 0 | 19th-20 th +R | |
| 306 | T20 | L1 | 9 | 0 | 0 | 0 | 0 | 0 | 0 | 0 | 0 | 0 | 0 | 0 | 0 | 0 | 0 | 17th-18th +R | |
| 313 | T28 | L1 | 58 | 0 | 0 | 0 | 0 | 0 | 0 | 0 | 0 | 0 | 0 | 0 | 0 | 0 | 0 | 17th-18th +R | |
| 332 | T34 | L1 | 19 | 0 | 0 | 0 | 0 | 0 | 13 | 0 | 0 | 6 | 0 | 0 | 0 | 0 | 0 | 19th-20th +R | |
| 335 | T40 | L1 | 8 | 0 | 0 | 0 | 0 | 0 | 0 | 0 | 0 | 0 | 0 | 0 | 0 | 0 | 0 | 17th-18 th | |
| 349 | T48 | L1 | 11 | 0 | 0 | 0 | 0 | 7 | 0 | 0 | 0 | 1 | 0 | 0 | 0 | 0 | 0 | 19th-20th +R | |
| 356 | T34 | L1 | 10 | 0 | 0 | 13 | 0 | 0 | 0 | 0 | 0 | 4 | 0 | 0 | 0 | 0 | 0 | 19th-20th +R | |
| 367 | T50 | L1 | 0 | 0 | 0 | 0 | 66 | 0 | 0 | 0 | 0 | 0 | 0 | 0 | 0 | 0 | 0 | late 15 th | |
| 373 | T38/T3 | L1 | 5 | 0 | 0 | 6 | 0 | 7 | 0 | 0 | 0 | 0 | 0 | 0 | 0 | 0 | 0 | 17 th -18th +R | |
| 416 | T38 | L1 | 25 | 0 | 0 | 0 | 0 | 0 | 0 | 0 | 0 | 0 | 0 | 0 | 0 | 0 | 0 | 17th-18 th | |
| 437 | T46 | L1 | 0 | 0 | 0 | 0 | 0 | 0 | 0 | 0 | 0 | 13 | 0 | 0 | 20 | 0 | 0 | 19th-20th +R | |
| 462 | T50 | L1 | 0 | 0 | 0 | 0 | 0 | 0 | 0 | 0 | 0 | 0 | 0 | 0 | 0 | 1 | 0 | 19th 20 th | |
| 615 | T37 | L1 | 13 | 0 | 0 | 0 | 0 | 0 | 0 | 0 | 0 | 0 | 0 | 0 | 0 | 0 | 0 | 17th-18 th | |
| 618 | T43 | L1 | 0 | 0 | 0 | 0 | 0 | 0 | 5 | 0 | 0 | 21 | 0 | 0 | 17 | 0 | 0 | 19 th -20 th | |
| 687 | T56 | L1 | 2 | 0 | 0 | 0 | 0 | 0 | 0 | 0 | 0 | 3 | 0 | 0 | 0 | 0 | 0 | 19th 20th +R | |
| 852 | T68 | L1 | 9 | 0 | 0 | 0 | 0 | 0 | 0 | 0 | 10 | 69 | 0 | 0 | 0 | 8 | 0 | 20th +R | |
| 904 | T73 | L1 | 8 | 0 | 0 | 0 | 0 | 21 | 0 | 5 | 0 | 7 | 61 | 0 | 0 | 0 | 0 | 19th-20th +R | |
| 926 | T3 | L1 | 2 | 0 | 0 | 3 | 0 | 0 | 0 | 0 | 0 | 26 | 0 | 0 | 0 | 0 | 0 | 19th-20th +R | |
| 927 | T74 | L1 | 16 | 0 | 0 | 0 | 0 | 28 | 0 | 12 | 0 | 0 | 0 | 0 | 0 | 0 | 0 | 19th-20th +R | |
| 1006 | T87 | L1 | 0 | 0 | 0 | 0 | 0 | 0 | 0 | 0 | 0 | 20 | 0 | 0 | 0 | 17 | 0 | 19th-20th | |
| 1031 | T105 | L1 | 14 | 0 | 0 | 0 | 0 | 0 | 0 | 0 | 0 | 21 | 0 | 0 | 0 | 0 | 20 | 19th-20th +R | |

| | | | fabrics | | | | | | | | | | | | | | | |
|--------|--------|---------------|---------|-----|----|-----|-----|-----|-----|-----|----|-----|------|-----|----|-----|-----|----------------|
| Find n | Trench | Cont-ext | 40 | 40a | 42 | 45 | 45c | 45d | 45f | 45m | 46 | 48b | 48d | 48e | 50 | 51a | 51b | context date |
| 1032 | T106 | L1 | 0 | 0 | 0 | 0 | 0 | 0 | 0 | 0 | 0 | 0 | 12 | 0 | 0 | 0 | 0 | 19th-20th |
| 284 | T25 | L1/F60 | 1 | 0 | 0 | 0 | 0 | 0 | 0 | 0 | 0 | 0 | 0 | 0 | 0 | 0 | 0 | 17th-18th |
| 849 | T64 | L1/F151 | 0 | 0 | 0 | 0 | 0 | 0 | 0 | 38 | 0 | 0 | 0 | 0 | 0 | 0 | 0 | 19th-20th |
| 1028 | T101 | L1/L2 | 0 | 0 | 0 | 0 | 0 | 0 | 0 | 0 | 0 | 0 | 0 | 0 | 0 | 43 | 0 | 19th-20th |
| 362 | T27 | L1/L16 | 9 | 0 | 15 | 0 | 0 | 0 | 0 | 0 | 0 | 0 | 0 | 0 | 0 | 0 | 0 | 17th |
| 888 | T67 | L1? | 0 | 0 | 0 | 0 | 0 | 0 | 0 | 0 | 0 | 0 | 12 | 0 | 0 | 0 | 0 | 19th-20th +R |
| 21 | T5 | L2 | 0 | 0 | 0 | 0 | 0 | 0 | 0 | 0 | 0 | 0 | 8 | 0 | 0 | 0 | 0 | 19th-20th +R |
| 43 | | L2 | 20 | 0 | 0 | 0 | 0 | 0 | 0 | 0 | 0 | 0 | 0 | 0 | 0 | 0 | 0 | 17th-18th |
| 74 | T11 | L2 | 0 | 0 | 0 | 0 | 0 | 5 | 0 | 0 | 0 | 0 | 0 | 0 | 0 | 0 | 0 | late 16th |
| 85 | T8 | L2 | 10 | 0 | 0 | 0 | 0 | 0 | 0 | 0 | 0 | 0 | 1 | 0 | 0 | 0 | 0 | 19th-20th +R |
| 130 | S2 | L2 | 0 | 0 | 0 | 0 | 0 | 0 | 0 | 0 | 0 | 0 | 18 | 0 | 0 | 0 | 0 | 19th-20th +R |
| 703 | T56 | L2 | 4 | 0 | 0 | 0 | 0 | 0 | 0 | 0 | 0 | 0 | 0 | 0 | 0 | 0 | 0 | 17th-18th |
| 707 | T56 | L2 | 58 | 0 | 0 | 0 | 0 | 0 | 0 | 0 | 0 | 0 | 7 | 0 | 0 | 0 | 0 | 19th-20th +R |
| 142 | S3 | L11 | 39 | 0 | 0 | 14 | 0 | 0 | 0 | 0 | 0 | 0 | 0 | 0 | 0 | 0 | 0 | 17th +R |
| 309 | T33 | L15 | 0 | 0 | 0 | 8 | 0 | 0 | 0 | 0 | 0 | 0 | 0 | 0 | 0 | 0 | 0 | prob 15th-17th |
| 418 | T37 | L16 | 0 | 0 | 0 | 0 | 0 | 18 | 0 | 0 | 0 | 0 | 7 | 0 | 0 | 0 | 0 | 19th-20th +R |
| 983 | T83 | L17 | 0 | 0 | 0 | 0 | 0 | 0 | 0 | 0 | 0 | 0 | 6 | 0 | 0 | 0 | 32 | 19th-20th +R |
| 396 | T56 | L28 | 28 | 0 | 0 | 0 | 0 | 0 | 0 | 0 | 0 | 0 | 0 | 0 | 0 | 0 | 10 | 19th-20th +R |
| 729 | T60 | L34 | 0 | 0 | 0 | 49 | 0 | 0 | 0 | 0 | 0 | 0 | 0 | 89 | 0 | 0 | 22 | 19th-20th |
| 816 | T62 | L36 | 2 | 0 | 0 | 0 | 0 | 0 | 0 | 0 | 0 | 0 | 0 | 0 | 0 | 0 | 0 | 17th-18th |
| 960 | T82 | L38 | 9 | 0 | 0 | 0 | 0 | 0 | 0 | 0 | 0 | 0 | 0 | 0 | 0 | 0 | 0 | 17th-18th |
| 1001 | T85 | L38 | 0 | 0 | 0 | 0 | 0 | 0 | 0 | 0 | 0 | 5 | 0 | 0 | 0 | 0 | 0 | 19th |
| 1011 | T84 | L38 | 29 | 0 | 0 | 0 | 0 | 0 | 0 | 0 | 0 | 0 | 0 | 0 | 0 | 0 | 0 | 17th-18th |
| 1203 | T126 | L1 | 0 | 0 | 2 | 0 | 0 | 0 | 0 | 0 | 0 | 0 | 0 | 0 | 0 | 0 | 0 | late 16th-17th |
| 899 | T66 | L36 | 0 | 0 | 0 | 0 | 0 | 0 | 0 | 0 | 0 | 0 | 2 | 0 | 0 | 0 | 0 | 19th-20th |
| | | totals | 819 | 64 | 66 | 182 | 66 | 122 | 13 | 273 | 49 | 38 | 1326 | 89 | 86 | 173 | 167 | 3,533 |

Appendix 8: catalogue of Roman tile

by Ernest W Black

The tiles present in each context are briefly described, with Roman contexts being listed together at the start. Measurements are given in millimetres. Find numbers are in brackets.

[Abbreviations: exth external height of flange; F feature; frag. fragment(s); imb. imbrex / imbrices; L layer; teg. tegula(e); T trench; S soakaway; unid. Unidentifiable.]

Roman contexts (? Preceding an entry means the context is not certainly Roman)

- (2) L3, T2 teg. base (thickness 14-15)
?(8) L2 / L3, T5 3 unid. (2 of which burnt)
?(18) F5, T4 1 unid.
(143) L12, S3 ?imb. (thickness 12-16), 3 ?tegula bases (thickness 17, 17, 17), 2 teg. bases (thickness 18 with signature, thickness 25-28)
(149) F43/ L13, S3, 1 unid., 1 tegula base (thickness 18) with signature, 1 teg. base (thickness 22-24) and flange (exth 43-48)
(290) F59, T23 6 unid.
(341) F85, T27 5 unid. (1 of which burnt), 2 imbrices (Also 5 peg-tiles)
(346) F83, T30/35 1 unid.
? (364) F74, T27 8 unid.
?(374) L23, T37 1 unid. (thickness at least 19)
?(389) F98, T49 2 unid., 1 brick (thickness at least 42), 2 tegula bases (thickness 15, thickness 21)
?(464) F110, T50 3 unid.
(516) F47, 3 unid.
?(546) F122, T46 1 unid., 2 tegula bases (thickness 13/14, thickness 18), 2 joining tegula bases (thickness 15) with ?footprints of animal / bird
?(564) F125, T21 3 unid., 1 burnt imb., 3 tegula bases (thickness 12, thickness 16 and burnt, thickness 21), 2 ?tegula bases (thickness 24, thickness 25/26)
(570) L30, T45 2 x imb., tegula base (thickness 16), tegula base (thickness 22) and flange
(614) F117, T45 6 unid.
?(640) F110, T50 1 unid., (1 peg-tile present)
(657) F130, T54 1 tegula base (thickness 23)
(658) F121, T54 7 unid., 1 brick (thickness 30), 1 damaged tegula flange
(659) F117, T45 1 unid., ?tegula base (thickness 18)
?(674) F125, T21 1 unid. (in white fabric), 1 teg. base (thickness 20)
(680) F137, T45 6 unid., 2 burnt bricks (thickness 30, thickness at least 34 and glazed), 1 tegula base (thickness 17-19), 2 abraded tegula flanges
(843) F156, T56 2 unid., 1 tegula base (thickness uncertain)
(926) L3, T22 3 unid., 2 tegula bases (thickness 14, T18), ?tegula base (thickness 25), unkeyed face (thickness 17) of hollow voussoir with part of cutaway (with slight rim to cutaway on outer face)
? (928) L39/40, T77/78 5 unid.
(949) F43/ L13, S3 1 unid., 1 tegula base (thickness 18), 1 teg. base (thickness 22-24) and flange
(1003) F141, T94 2 unid.
(1004) F141, T94 1 unid. (burnt)
?(1029) F193, T99 1 brick (thickness 29-30), 2 ?teg. bases (thickness 17, T20), 2 tegula bases (thickness 14, T16-17), 1 burnt teg. base (thickness 17) and flange (exth 42-44)
(1039) F43, T107 1 unid.
?(1052) F194, T103 2 unid., 1 tegula base (thickness 19/20) and flange (exth approx 40)
(1067) F197, T109 approx 40 unid. Chips of tile and plaster
(1076) F197, T109 13 unid.
(1171) L3, T113 1 burnt brick (thickness 49) with signature, 3 joining fragments *imbrex*, 1 burnt tegula base (thickness 23)
?(1179) F202, S6 1 burnt brick (thickness 30), 1 tegula base (thickness 18-24)
?(1190) F207, T66 2 unid. (burnt), 1 burnt ?tegula base (thickness 20/21)

Post-Roman contexts

- (14) F4, T2 1 tegula base/ brick (thickness 25), 1 tegula base (thickness 21), 1 small part of tegula flange
(21) L2, T5 2 unid., 1 very abraded combed face of box-tile (thickness 17), 1 ?imb., 1 abraded tegula base (thickness 25) and flange (exth approx 40)
(25) F8, T7 1 unid.
(33) F11, T3 3 unid., 1 ?imb.
(42) F14, T9 3 unid., 1 burnt ?imb.
(43) L2, T9 5 unid.
(47) F12, T4 6 unid., 1 ?brick (thickness 25), 1 ?imb.
(60) F8, T7/13 1 unid., 1 teg. base (thickness 16)
(63) L2, T9 1 teg. base (thickness 19)
(85) L2, T8 1 unid., 2 bricks (thickness 32 and thickness 42 burnt), 3 teg. bases (thickness 16, thickness 18 and thickness 23)
(88) F32, T9 ?teg. base (thickness uncertain)

- (91) F34, T13 1 teg. base (thickness 21)
(96) F8, T7/13 3 unid., 1 brick (thickness 31), 1 imb., 1 burnt teg. base (thickness 16)
(99) F32, T9/15 2 unid., 1 combed face of box-tile (thickness 13), 3 bricks (thickness 28, thickness 29 burnt, thickness 30)
(105) F38, T7 1 unid., 1 burnt brick (thickness 30)
(107) ?F39, T8 1 burnt ?box-tile (T19/T20) with two very shallow tooth-marks, 1 tegula base thickness 18)
(121) F39, T8 1 combed face of box-tile (thickness 18-19), 1 burnt brick (thickness 26/27), 1 imbrex, 1 burnt teg. base (thickness 17-18), 1 burnt teg. base (thickness 18) and flange (exth 42)
(123) L2, T4 1 very abraded and burnt combed face of box-tile (thickness 15)
(154) L1, T14 8 unid., 1 ?imb., 1 imbrex, 1 burnt ?tegula base (thickness 12/13), 1 very abraded tegula flange
(155) L1, T15 1 unid.
(185) F46, T14 3 unid., combed face of box-tile, burnt (thickness 15-17), 2 bricks (thickness 31, thickness incomplete), ?brick (thickness 26), 2 imb., 1 tegula base (thickness incomplete), 1 tegula base (thickness approx 19) with flange (exth approx 39), 1 possible tessera (11 / 25 x 32, T 18)
(192) F52, T18 1 unid., 2 bricks (thickness uncertain and burnt, thickness 34), 1 imbrex.
(206) L1, T19 1 unid. (?thickness 21), burnt
(207) L1, T19 2 unid.
(218) F55, T22 2 unid.
(220) L1, T21 1 burnt teg. base (thickness 22)
(221) L1, T21 2 unid.
(235) F58, T20 3 unid., 1 imb.
(236) L1, T20 4 unid.
(237) F55, T19 1 unid.
(271) L1, T23 1 unid.
(272) L1, T23 1 unid.
(284) L1, F60 T25 3 unid. (one burnt)
(286) L1, T23 2 unid.
(295) L1, T16/T26 12 unid., 1 imbrex, 1 very abraded tegula flange
(296) L1, T26 3 unid.
(301) F63, T16 1 burnt brick (thickness 35), 1 tegula base (thickness 17/18), 1 burnt tegula base (thickness 21) with part of cutaway flange (Brodrigg Type ?5) from bottom left corner and signature
(303) F62, T14 1 unid.
(304) L19, T23 1 imb. 2 tegula bases (thickness 21, thickness 23)
(309) L15, T33 1 brick (thickness at least 31)
(312) F68, T38 1 brick (thickness 31), 1 possible tessera (30 x 32, thickness 17)
(313) L1, T28 5 unid.
(316) F72, T40 1 tegula base (thickness 15-18)
(331) F77, T31 burnt ?brick (thickness at least 25)
(332) L1, T34 1 burnt unid., 1 burnt imb.
(336) L17, T26 3 unid.
(352) L1, T35 1 unid., 2 tegula bases (thickness 15, thickness uncertain)
(357) F91, T24 13 unid., 1 ?tegula base (thickness 13)
(358) F91, T26 2 unid., 1 burnt tegula base (thickness 18)
(360) L25, T37 3 unid., 2 bricks, burnt on one surface (thickness 27-32)
(362)L1/L16, T27 3 unid., 1 brick (thickness at least 28)
(362)L1, T37/38 3 unid.
(384) F68, T32 1 tessera (30 x 22, thickness 15/16)
(386) F91, T27 3 unid.
(388) F96, T27 1 unid., 1 tessera (26 x 20, thickness 15)
(391) L1, T49 1 ?tessera (approx 25 x 35, thickness 15 with slight mortar traces on base)
(396) L28 T56 6 unid., 1 combed face of box-tile (thickness 19)
(400) L28, T56 3 burnt unid. (one thickness at least 18, one thickness at least 22), 1 burnt ?brick (thickness c.24)
(407) L1, T38 5 unid.
(414) F105, T38 1 unid.
(416) L1, T38 1 unid.
(420) F106, T47 3 unid., 1 brick (thickness 34), 2 tegula bases (thickness 24 burnt with signature, thickness 25-27)
(421) F106, T47 1 ?tegula base (thickness 18-20)
(437) L1, T46 4 unid., 1 ?brick (thickness approx 24)
(437) L1, T45 1 burnt teg. base (thickness approx 21/22) with signature
(439) L1, T50 1 unid., 1 ?teg. base (thickness 18), 1 tegula base (thickness 23) and flange (exth 47) with ?part of cutaway (Brodrigg 1987, Type 5) from bottom right corner
(440) L1, T54 1 brick (thickness at least 50)
(450) L1, T47 2 unid., 1 imb., 2 bricks (thickness 36, T38), 3 teg. bases (thickness c.18, thickness c.19 ?burnt, thickness 21), teg. base (thickness 22 with burning) and damaged flange, ?tessera (20 x 21, thickness 22)
(459) L8, T46 1 unid., 2 bricks (thickness 25-30, T approx 31 burnt), 1 burnt tegula base (thickness 18)

- (460) L1, T53 1 burnt *tegula* base (thickness 18)
(462) L1, T50 1 ?*tessera* (approx 18 x 30, thickness 18)
(473) L1, T55 1 unid., 1 *tegula* base (thickness approx 16) and much damaged flange (exth at least 48)
(563) L1, T21 4 unid., 1 combed face of box-tile/voussor (thickness 25), 1 brick (thickness 29), 2 *tegula* bases (thickness 17, T19 and mortared and burnt), 1 burnt *tegula* base with mortar over burning (thickness 17/18, probably from the same tile as *tegula* base above) and flange (exth approx 38), ?*teg* flange (exth approx 43)
(615) L1, T37 1 unid., 1 *tessera* (22 x 22, thickness 21), 1 probable *tessera* (19 x 26, thickness 19)
(666) F117, T45/T54 (5 fragments of probably post-Roman brick), 1 mortared brick (thickness 32-35)
(702) F145, T56 2 unid.
(704) F144, T56 1 brick (thickness 34)
(727) L2, T56 2 unid. (one burnt), 1 ?brick (thickness 28), 1 burnt brick (thickness 33), 1 *imbrex*, ?*tegula* base (thickness 19/20), 1 burnt *tegula* base (thickness 18/19), 2 *tegula* flanges (one from cutaway)
(786) F152, T56 13 unid., 1 *tegula* base (thickness approx 20)
(794) F151, T60 1 ?box-tile (thickness 13) with shallow combing
(844) L1, F4, T60 2 burnt unid.
(852) L1, T68 22 unid., 1 mortared and burnt combed face of box-tile (thickness 16-18), 10 bricks (thickness 29, thickness 30, thickness at least 31, 2 x thickness 32, thickness 32 heavily burnt, thickness at least 32, 2 x thickness 33, thickness at least 33), 3 *imb.*, 4 *tegula* bases (thickness 14, thickness c.18, 2 x thickness 20), 3 *tegula* flanges, 1 ?burnt *tegula* base (thickness 22-24), with flange (exth 38)
(861) L1, T68 1 burnt brick (thickness at least 30)
(888) U/S, T67 burnt *teg.* base (thickness 24/25)
(890) F150, T59 1 *teg.* base (thickness 22), 1 *tegula* base (thickness 26) and flange (exth 50-55)
(892) F150, T60 ?burnt *teg.* base (thickness 15), ?burnt *teg.* base (thickness 16) and flange (exth 39) - these two may be parts of the same tile, 1 ?burnt *tegula* base (thickness 22) and flange (exth 42)
(896) F170, T72 1 brick (thickness approx 30), 2 *imb.*, 1 *tegula* base (thickness approx 19), 1 abraded *tegula* base and flange
(898) F173, T71 8 unid.
(899) L36, T66 10 unid., 3 brick (thickness 35, 35, 38), 1 *imbrex*, 1 *tegula* flange, 1 *tegula* base (thickness c.13) and part of flange
(899) L38, T85 6 unid., 3 bricks (thickness at least 25, thickness approx 30, thickness 35), 5 *teg.* bases (thickness uncertain, 13, 18, 19, 20), *teg* base (thickness 17) and flange (exth 40)
(904) L1, T73 8 unid., 1 combed face of box-tile (thickness 14), 1 ?brick (thickness 29), 4 bricks (thickness approx 30 with signature, thickness 34 burnt, thickness approx 38, thickness 56 ?burnt), 4 *imb.*, 1 ?*tegula* base (thickness 18), 2 *tegula* bases (thickness 18, thickness 16-20), *tegula* base (thickness approx 15) and part of flange, 1 *tegula* flange with cutaway from bottom left
(905) F166, T73 1 unid., 1 *imb.*, 1 mortared *tegula* base (thickness 27) with signature, 1 *tegula* base (thickness 20) with part of flange
(911) L1, T77 7 unid., burnt combed face of ?box-tile (thickness approx 21), 5 bricks (thickness 25, thickness 26/27, thickness 31, thickness 37, thickness 38/40), 4 *imb.*, 9 *tegula* bases (thickness uncertain, thickness 14, thickness 15, thickness 17, thickness 18, thickness 19, thickness 20, thickness 20/21, thickness 21), 1 *tegula* base (thickness approx 18) with flange (exth 39)
(913) F150 T59/60 1 burnt *tegula* base (thickness 17-19) with MOB, 1 *tegula* base (thickness 15/16) with flange (exth approx 40) from bottom right corner (Brodrigg type 5)
(917) L1, T76 1 unid., 3 *tegula* bases (thickness 17, thickness 19/20, thickness 20), 1 *tegula* flange (exth 38)
(917) L1 T74 1 *imbrex*.
(927) L38, T82 1 unid., 1 burnt brick (thickness approx 33), 1 *imbrex*, 1 abraded *tegula* flange (exth approx 39)
(965) L38, T81 1 unid., 2 burnt bricks (thickness 34, T39), 1 *imb.*
(973) L1, T76 1 *tegula* base (thickness 13)
(975) F185, T81 2 unid. (one thickness 12), 1 very abraded ?brick (thickness approx 30), 1 *tegula* base (thickness 15), 1 *tegula* base (thickness 19) and flange (exth 32)
(976) L1, T80 1 combed face of box-tile (thickness approx 18), 1 *tegula* base (thickness 26) and cutaway flange from bottom right corner (Brodrigg 1987, Type 2) (exth 54)
(977) U/S, T90 2 unid., 1 *tegula* base (thickness 17-22)
(978) U/S, T89 1 unid., 1 *imbrex*, 1 heavily burnt ?brick (thickness at least 27), 1 *tegula* base (thickness c.22) and flange, 1 very abraded *teg.* base and small part of flange
(983) L1?, T83 4 unid. (one burnt), combed face of box-tile (thickness 15), 4 bricks (thickness 29, thickness 30, thickness 31, thickness 36), 1 *imbrex*, 5 *tegula* bases (thickness 15, thickness 16 and burnt, thickness 17 with signature, thickness 19, thickness 19/20), small part of *tegula* base (thickness 19) and flange (exth 34/35), 1 *tegula* base (thickness 18/19) and flange (exth 45)
(992) L1/L2, T79 6 unid., 1 ?burnt brick (thickness 38-39), 1 *imbrex*, 1 ?*tegula* base (thickness 22), 1 *tegula* base (thickness 14)
(995) L1/L2, T92 1 brick (thickness 32), 1 very abraded *teg.* base (thickness c.17/c.19) and flange
(1006) L1, T87 3 unid., 4 bricks (thickness 24 and burnt, thickness at least 26, thickness c.30, thickness 35), 2 *tegula* bases (thickness 18-21, thickness 19 and burnt)
(1028) L1/L2, T101 2 ?*teg.* bases (thickness 15, thickness 18), 1 abraded *teg.* flange (exth c.45)
(1031) L1, T105 2 unid., 1 brick (thickness 31)
(1032) L1, T106 2 unid.

(1100) F39, T8 3 unid. (2 burnt), 1 burnt combed face of box-tile (thickness 15), 2 joining bricks, burnt before breakage (thickness 34), 1 burnt brick (thickness 35), 1 burnt imb., 1 burnt teg. base (thickness 25), 1 mortared teg. base (thickness 19/20), 1 teg. base (thickness 21) and flange (exth 46), 1 teg. base (thickness 19) and flange (exth estimated at 45)

(1170) L2, T113 2 bricks (thickness 35/36, thickness 37)

(1192) F151, T120-T123 3 unid.

(1193) L2, T124 6 unid. (2 burnt), 3 bricks (thickness 32, thickness 34, thickness 40 burnt), 1 *imbrex*, 2 teg. bases (thickness 20, thickness 20), 1 tegula flange, 1 mortared *tessera* (28 x 15, thickness 18)

(1203) L1, T126 3 unid., 2 imbrices.

(27) F10, T5 1 unid. (thickness at least 25)

(413) F100, T56 (date not known) 8 unid.

(453) F112, T47 (date not known) 1 burnt brick (thickness 31), 1 *imbrex*.

(638) F116, T53 (date not known) 1 *imbrex*.

No label - 5 unid., 1 *imbrex*, 2 *tegula* bases (thickness 18, and thickness 21), abraded *tegula* base (thickness approx 19) and flange, very abraded tegula base and part of flange.

Appendix 9: catalogue of clay pipes

by Nina Crummy

Table 57: list of clay tobacco pipes by context.

| Find No | Trench | Feature Layer | Context description & date | Identification | Type (CAR 5) | Notes/Date | Bore diameter (m) |
|---------|--------|---------------|---|-------------------------------|--------------|---|-------------------|
| 60 | T7/13 | F8 | excavation trench; modern | 3 stem fragments | - | - | 2 x 2.5, 3 |
| 96 | T7/13 | F8 | excavation trench; modern | 3 stem fragments | - | - | 2 x 2, 2.5 |
| 33 | 3 | F11 | pit or ditch /excavation trench; 19th cen | 1 stem fragment | - | - | 2 |
| 33 | 3 | F11 | pit or ditch /excavation trench; 19th cen | 1 bowl + narrow foot fragment | - | S C in relief on sides of foot = Stephen Chamberlain, 1728-1808, or Stephen Chamberlain Rand, working c 1810-60 | 2 |
| 97 | 7 | F20 | drain; modern | 1 stem fragment | - | - | 2 |
| 86 | 13 | F34 | pit; modern | 1 stem fragment | - | - | 2.5 |
| 91 | 13 | F34 | pit; modern | 1 stem fragment | - | - | 2 |
| 105 | 7 | F38 | ditch or pit/excavation trench; 19th cen | 1 stem fragment | - | - | 3 |
| 126 | 7 | F38 | ditch or pit/excavation trench; 19th cen | 1 stem fragment | - | - | 3 |
| 121 | 8 | F39 | pit; post-medieval | 2 stem fragments | - | - | 2, 2.5 |
| 185 | 14 | F46 | ditch/excavation trench; 19th century | 2 stem fragments | - | - | 1.5, 2.5 |
| 192 | 18 | F52 | ditch or pit/excavation trench; 19th cen | 1 stem fragment | - | - | 2.5 |
| 316 | 40 | F72 | ditch/excavation trench; 19th century | 1 stem fragment | - | - | 3 |
| 334 | 40 | F72 | ditch/excavation trench; 19th century | 1 stem fragment | - | - | 3 |
| 331 | 31 | F77 | pit/excavation trench; modern | 1 stem fragment | - | - | 1.5 |
| 341 | 27 | F85 | disturbed cremation; intrusive | 1 stem fragment | - | - | 2.5 |
| 358 | 26 | F91 | pit/excavation trench; modern | 1 stem fragment | - | - | 2.5 |
| 7204 | 56 | F144 | ditch; post-medieval or modern | 3 stem fragments | - | - | 2 x 2, 3 |
| 889 | 59 | F150 | rubble base; modern | 1 stem fragment | - | - | 2.5 |
| 890 | 59 | F150 | rubble spread; modern | 1 stem fragment | - | decorated on each side with panel or cartouche containing broad line of rouletting; 19th century | 1.5 |
| 891 | 61 | F150 | rubble base; modern | 2 stem fragments | - | - | 2 x 2 |
| 892 | 60 | F150 | rubble base; modern | 1 stem fragment | - | - | 1.5 |
| 794 | 60 | F151 | pit/excavation trench; modern | 2 stem fragments | - | - | 2, 2.5 |

| Find No | Trench | Feature Layer | Context description & date | Identification | Type (CAR 5) | Notes/Date | Bore diameter (m) |
|---------|--------|---------------|--------------------------------|--|--------------|-------------------------------|--|
| 905 | 73 | F166 | pit; modern | 1 stem fragment | - | - | 2 |
| 905 | 73 | F166 | pit; modern? | 1 bowl fragment | - | plain, mid 17th-18th century? | - |
| 898 | 71 | F173 | cut/drain; post-medieval | 1 stem fragment | - | - | 1.5 |
| 925 | 72 | F176 | disturbed cremation; intrusive | 1 stem fragment | - | - | 2 |
| 916 | 59 | F177 | cut; modern? | 1 stem fragment | - | - | 3 |
| 1182 | - | F204 | disturbed Roman cremation | 2 stem fragments | - | - | 2.5, 3 |
| 193 | 18 | L1 | topsoil | 1 stem fragment | - | - | 1.5 |
| 285 | 20 | L1 | topsoil | 1 stem fragment | - | - | 3 |
| 292 | 20 | L1 | topsoil | 3 stem fragments | - | - | 2 x 2.5, 3 |
| 306 | 20 | L1 | topsoil | 1 stem fragment | - | - | 2.5 |
| 221 | 21 | L1 | topsoil | 1 foot fragment | - | - | 3 |
| 272 | 23 | L1 | topsoil | 2 stem fragments | - | - | 1.5, 3 |
| 295 | 26 | L1 | topsoil | 2 stem fragments | - | - | 2 x 2.5 |
| 295 | 26 | L1 | topsoil | 1 foot fragment;
3 stem fragments | - | - | 2 x 2, 2 x 3 |
| 296 | 26 | L1 | topsoil | 1 stem fragment | - | - | 2 |
| 313 | 28 | L1 | topsoil | 11 stem fragments | - | - | 1.5, 2 x 2, 2.5, 7 x |
| 294 | 29 | L1 | topsoil | 1 foot fragment;
5 stem fragments | - | - | 2.5; 2 x 2, 2 x 2.5, |
| 293 | 30 | L1 | topsoil | 2 stem fragments | - | - | 2, 2.5 |
| 332 | 34 | L1 | topsoil | 1 bowl fragment;
10 stem fragments | - | plain | -; 3 x 2, 5 x 2.5, 2 x |
| 356 | 34 | L1 | topsoil | 1 bowl + foot
fragment; 2
fragments; 3
fragments; 17
fragments | 6 or 7? | c 1660-1700 | 2.5; 2, 3; -; 1.5, 4 x
x 2.5, 2 x 3 |
| 368 | 34 | L1 | topsoil | 6 stem fragments | - | - | 2 x 2, 3 x 3, 3.5 |
| 339 | 35 | L1 | topsoil | 1 bowl fragment;
1 stem fragment | 7 | c 1670-1700 | 3; 2.5 |
| 352 | 35 | L1 | topsoil | 1 stem fragment | - | - | 3 |
| 373 | 38/37 | L1 | topsoil | 1 stem fragment | - | - | 2 |
| 407 | 38 | L1 | topsoil | 1 stem fragment | - | - | 2 |
| 335 | 40 | L1 | topsoil | 2 stem fragments | - | - | 2 x 2.5 |
| 318 | 41 | L1 | topsoil | 1 stem fragment | - | - | 3 |

| Find No | Trench | Feature Layer | Context description & date | Identification | Type (CAR 5) | Notes/Date | Bore diameter (m) |
|---------|--------|---------------|--|-------------------------------------|--------------|---|-----------------------|
| 618 | 43 | L1 | topsoil | 1 stem fragment | - | - | 2.5 |
| 618 | 43 | L1 | topsoil | 1 bowl + foot fragment; 6 fragments | 6 or 7 | c 1660-1700 | 3?; 2, 2 x 2.5, 3 x 3 |
| 437 | 46 | L1 | topsoil | 3 stem fragments | - | - | 2 x 2, 2.5 |
| 450 | 47 | L1 | topsoil | 1 stem fragment | - | - | 2.5 |
| 349 | 48 | L1 | topsoil | 2 stem fragments | - | - | 2 x 3 |
| 367 | 50 | L1 | topsoil | 1 bowl fragment | 6 | c 1660-80 | 3 |
| 462 | 50 | L1 | topsoil | 1 stem fragment | - | - | 2.5 |
| 131 | 51 | L1 | topsoil | 1 stem fragment | - | - | 3 |
| 338 | 51 | L1 | topsoil | 6 stem fragments | - | - | 2, 3 x 2.5, 2 x 3 |
| 460 | 53 | L1 | topsoil | 1 stem fragment | - | - | 1.5 |
| 687 | 56 | L1 | topsoil | 1 foot fragment; 1 stem fragment | - | - | 3; 3 |
| 852 | 68 | L1 | topsoil | 3 stem fragments | - | - | 3 x 3 |
| 860 | 68 | L1 | topsoil | 1 stem fragment | - | - | 2 |
| 861 | 68 | L1 | topsoil | 1 stem fragment | - | - | 2 |
| 904 | 73 | L1 | topsoil | 5 stem fragments | - | one fragment has raised decorative resting bar (see CAR 5, no 2986) | 2 x 1.5, 2.5, 2 x 3 |
| 927 | 74 | L1 | topsoil | 1 stem fragment | - | - | 2 |
| 983 | 83 | L1? | topsoil | 1 stem fragment | - | - | 2 |
| 1032 | 106 | L1 | topsoil | 1 stem fragment | - | - | 2.5 |
| 362 | 27 | L1/L16 | topsoil | 4 stem fragments | - | - | 2, 2 x 2.5, 3 |
| 992 | 79 | L1/L2 | topsoil | 1 stem fragment | - | - | 3 |
| 995 | 92 | L1/L2 | topsoil | 1 stem fragment | - | - | 2.5 |
| 142 | 53 | L11 | topsoil; post-medieval or modern | 16 stem fragments | - | - | 2 x 2, 2 x 2.5, 3 |
| 418 | 37 | L16 | subsoil; post-medieval | 4 stem fragments | - | - | 2, 3 x 3 |
| 85 | 8 | L2 | topsoil/subsoil; post-medieval or modern | 1 stem fragment | - | - | 1.5 |
| 372 | 37 | L26 | rubble; modern | 1 bowl fragment | 6 | c 1660-80 | 2.5 |
| 396 | 56 | L28 | layer, modern or post-medieval | 1 stem fragment | - | - | 3 |
| 406 | 51 | L28 | layer, modern or post-medieval | 1 bowl fragment | 6 or 7 | c 1660-1700 | 3 |
| 899 | 66 | L36 | layer, modern | 2 stem fragments | | | |

Appendix 10: catalogue of miscellaneous finds

Table 58: list of miscellaneous finds.

| Find No | Context | Type | No of pieces | Weight in grams |
|---------|-------------|------------------------|--------------|-----------------|
| 8 | L2/L3 | Slag | 1 | 8 |
| 97 | F20 | Mod ceramic pipe | 1 | 74 |
| 170 | F45 | Coke | 3 | 6 |
| 175 | F45 | Slag | 4 | 2 |
| 205 | F47 | Sandstone | 1 | 4 |
| 218 | F55 | Coke | 1 | 17 |
| 285 | L1/T20 | Carbonised fruit stone | 3 | 4 |
| 290 | F59 | Slag | 21 | 14 |
| 320 | F71 | Charcoal | 8 | 15 |
| 331 | F77 | Slate | 1 | 3 |
| 334 | F72 | Slate | 1 | 17 |
| 341 | F85 | Coal | 4 | 3 |
| 349 | L1 | Tufa
Sandstone | 1
1 | 154 |
| 357 | F91 | Concrete | 1 | 14 |
| 358 | F91 | Slate | 5 | 31 |
| 360 | L25 | Slate | 1 | 7 |
| 364 | F74 | Slag | 1 | 4 |
| 373 | L1 | Charcoal | 2 | 1 |
| 386 | F91 | Septaria | 2 | 98 |
| 386 | F91 | Slate | 1 | 10 |
| 386 | F91 | Coal | 1 | 6 |
| 406 | L28 | Charcoal | 1 | 4 |
| 413 | F100 | Slate | 1 | 19 |
| 414 | F105 | Burnt pebble | 1 | 19 |
| 414 | F105 | Coal | 1 | 1 |
| 464 | F110 | Septaria | 1 | 462 |
| 542 | F114/Spit 3 | Charcoal | 3 | 19 |
| 563 | L1 | Septaria | 1 | 14 |
| 564 | F125 | Slate | 3 | 19 |
| 617 | F129 | Slag | 5 | 1 |
| 621 | F131 | Slate | 2 | 1 |
| 659 | F117 | Septaria | 1 | 25 |
| 786 | F152 | Sandstone | 1 | 51 |
| 786 | F152 | Coal | 2 | 3 |
| 790 | F155 | Coal | 1 | 12 |
| 794 | F151 | Slate
Coal | 1
1 | 17 |
| 845 | F134 | Charcoal | 2 | 9 |
| 852 | L1 | Septaria | 1 | 348 |
| 852 | L1 | Sandstone | 1 | 184 |
| 852 | L1 | Slag | 2 | 9 |
| 852 | L1 | Slate | 2 | 51 |
| 852 | L1/T68 | Limestone
Tufa | 2
1 | 610 |
| 889 | F150 | Septaria | 1 | 61 |
| 889 | F150 | Slag | 1 | 6 |
| 889 | F150 | Slate | 2 | 11 |
| 889 | F150 | Slag | 6 | 293 |
| 891 | F150 | Burnt coal | 3 | 9 |
| 898 | F170 | Coal | 1 | 4 |
| 899 | L36 | Slag | 1 | 30 |
| 904 | L1 | Sandstone | 1 | 2200 |
| 904 | L1 | Slate | 1 | 9 |
| 911 | L1 | Sandstone | 1 | 159 |
| 916 | F177 | Septaria | 1 | 29 |
| 960 | L38 | Sandstone | 1 | 402 |
| 965 | L38 | Septaria
Sandstone | 1 | 483 |
| 980 | F150 | mortar | 1 | 12 |

| | | | | |
|------|----------|-----------|---|-----|
| 983 | U/S | Sandstone | 1 | 926 |
| 983 | L1? T83 | Coal | 2 | 1 |
| 1001 | L38 | Flint | 1 | 200 |
| 1006 | L1 | Mortar | 1 | 13 |
| 1022 | L1 | Sandstone | 1 | 139 |
| 1074 | F197 | Slate | 1 | 10 |
| 1076 | F197 | Coal | 4 | 1 |
| 1193 | L2 | Septaria | 1 | 22 |
| 1193 | L2, T124 | Mortar | 1 | 6 |
| 1205 | F197 | Slag | 4 | 1 |

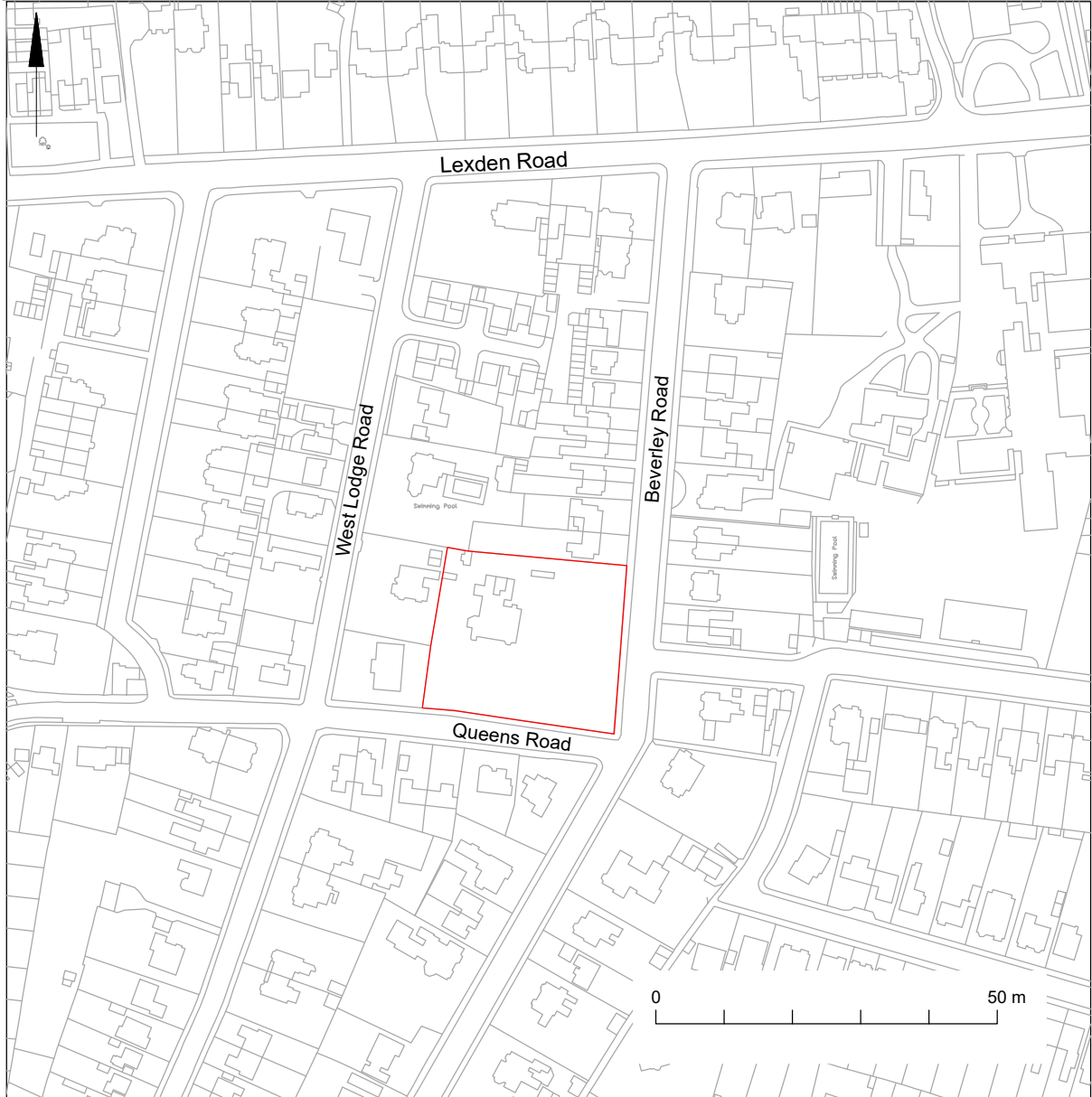
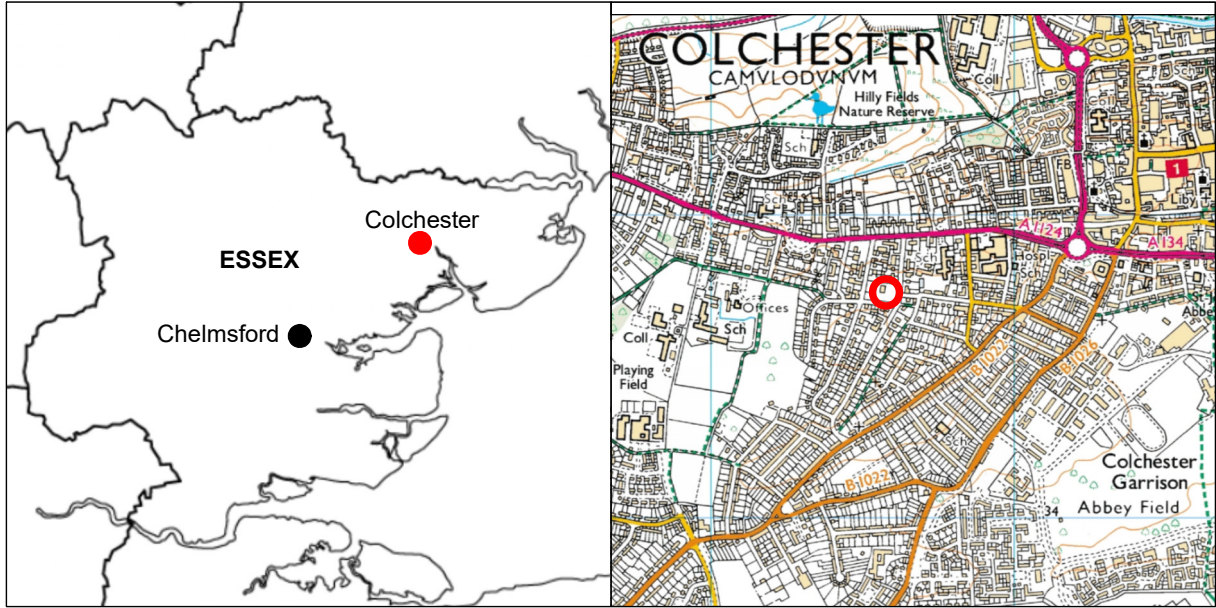


Fig 1 Site location.



© Crown copyright. All rights reserved. Licence number 100039294.

Fig 2 Map of Roman Colchester, showing site location (after CAR 9, fig 8.2, 259).

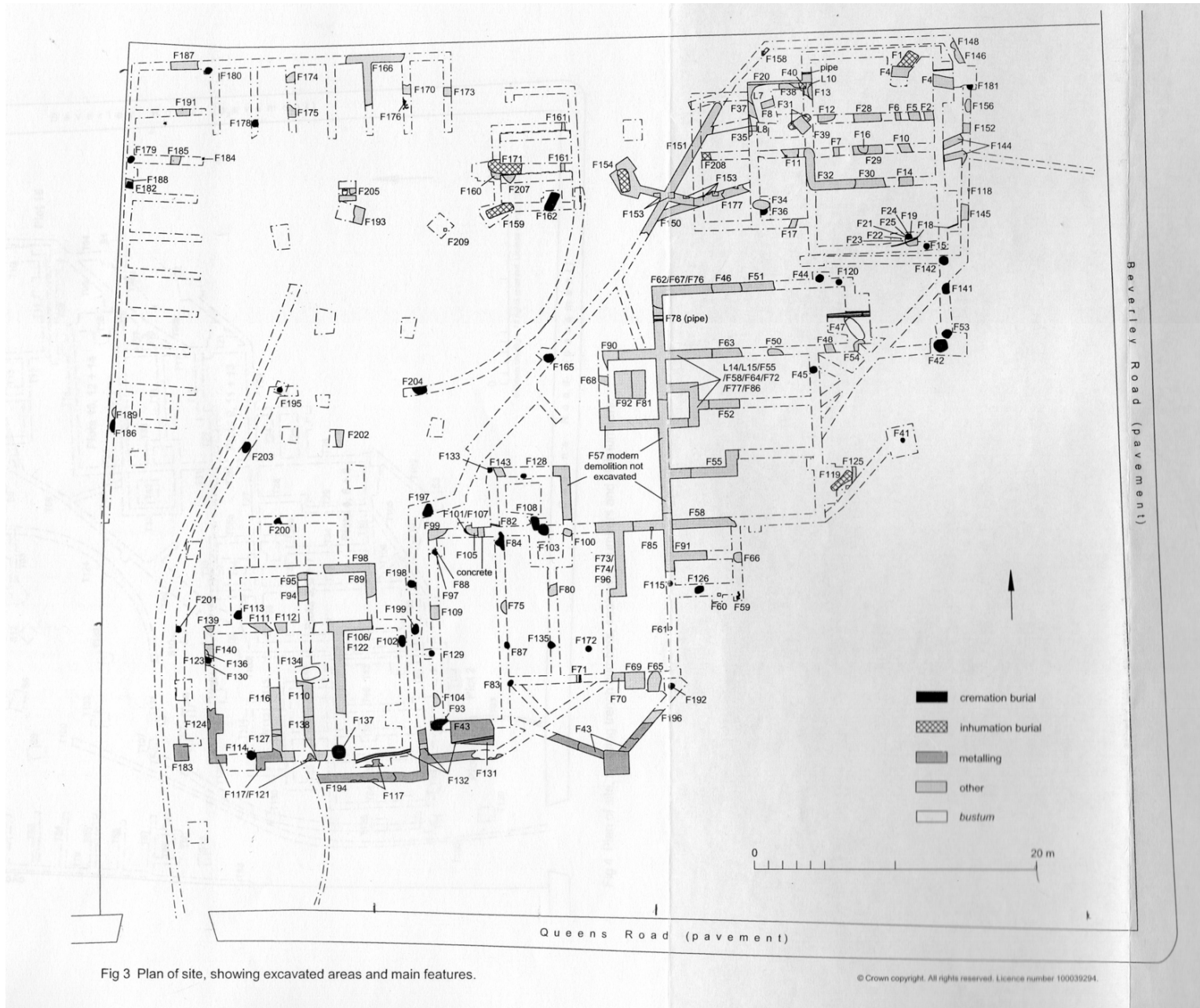


Fig 3 Plan of site, showing excavated areas and main features.

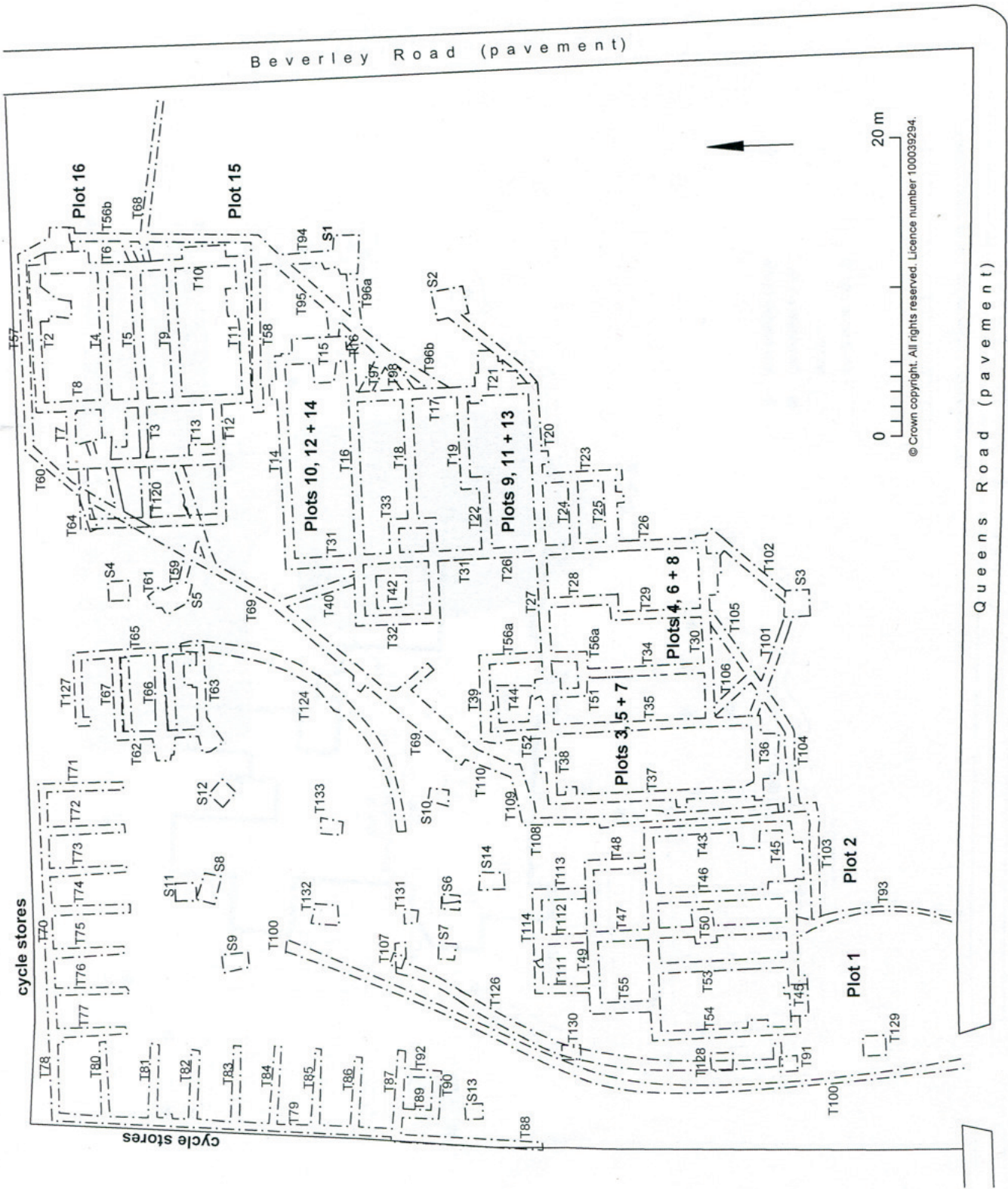
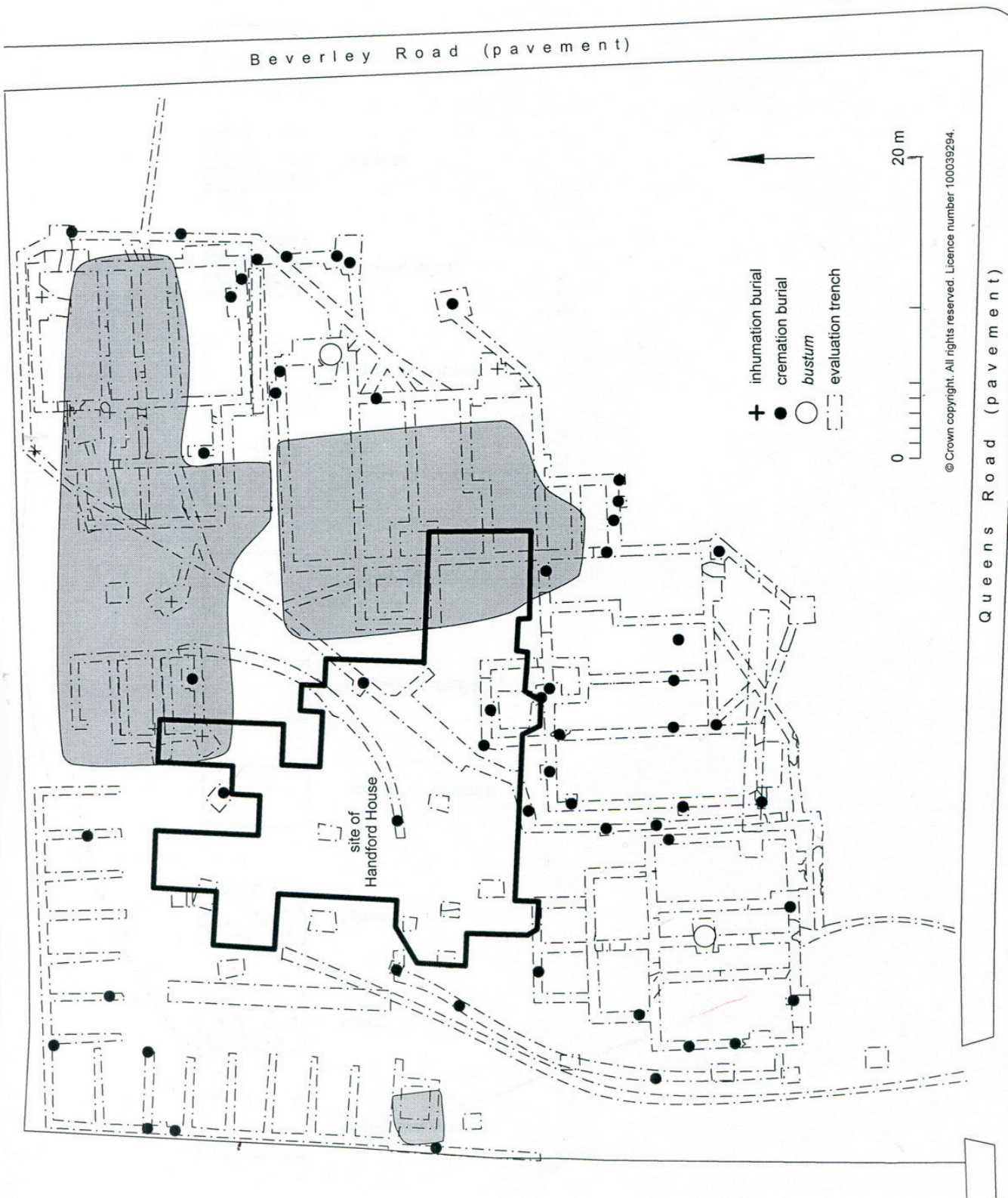


Fig 4 Plan of site, showing trench numbers, soakaway numbers and plot numbers.



© Crown copyright. All rights reserved. Licence number 100039294.

Fig 5 Plan of site, showing location of burials and busta, the footprint of the former Handford House, the three evaluation trenches, and the areas of 19th-century disturbance (toned).


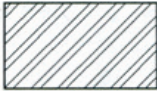


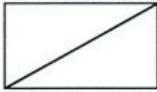


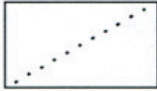
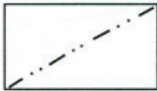




| | |
|---|-----------------------------|
|  | Roman tile |
|  | peg-tile |
|  | pottery |
|  | human bone |
|  | edge of context |
|  | break of slope |
|  | section/limit of excavation |
|  | uncertain edge of context |
|  | line of truncation |
|  | stones |
|  | nails |
|  | cremated bone |
|  | charcoal |

Fig 6 Key to plans and sections.

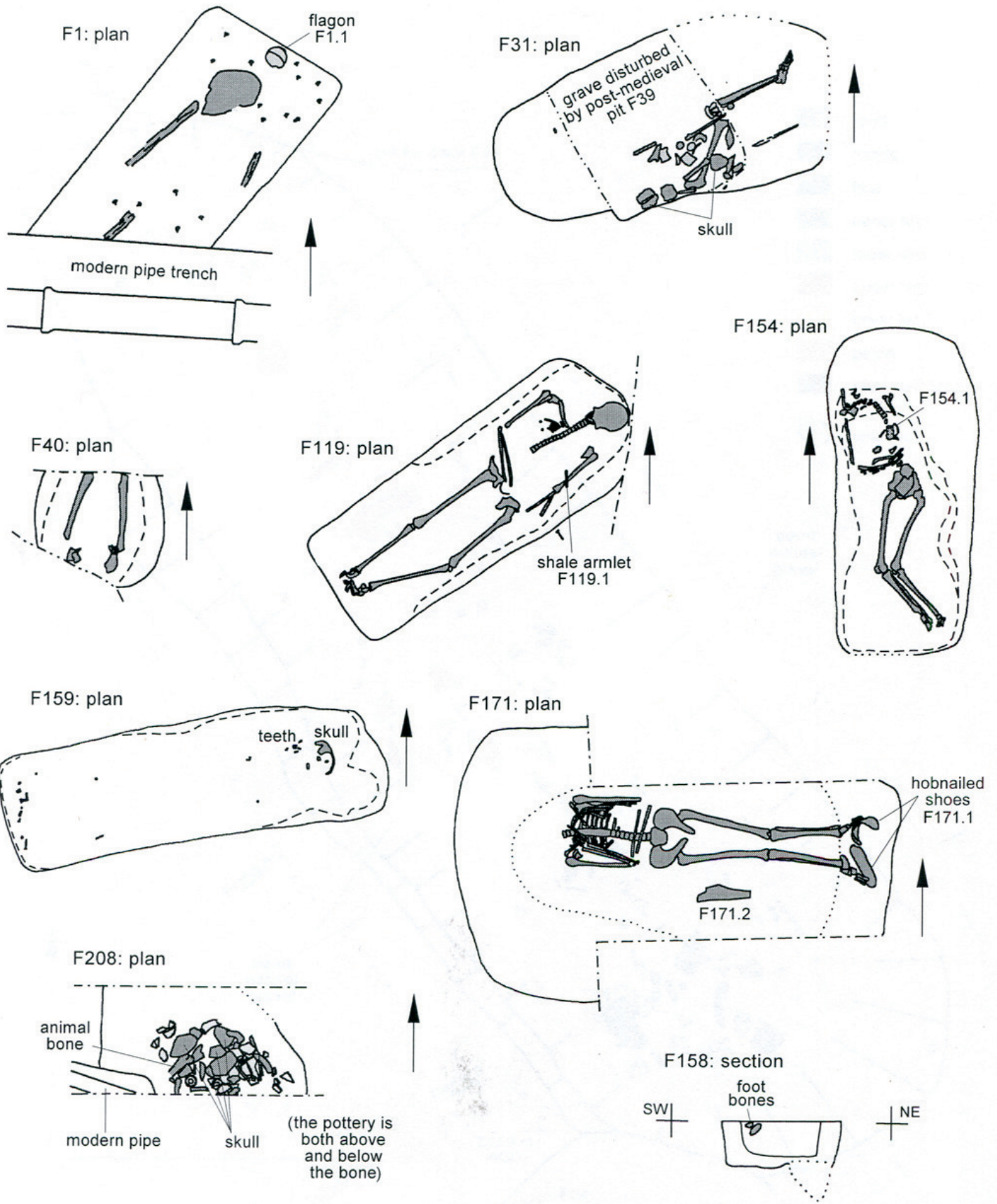


Fig 7 Inhumation burials F1, F31, F40, F119, F154, F159, F171, F208: plans; F158: section.

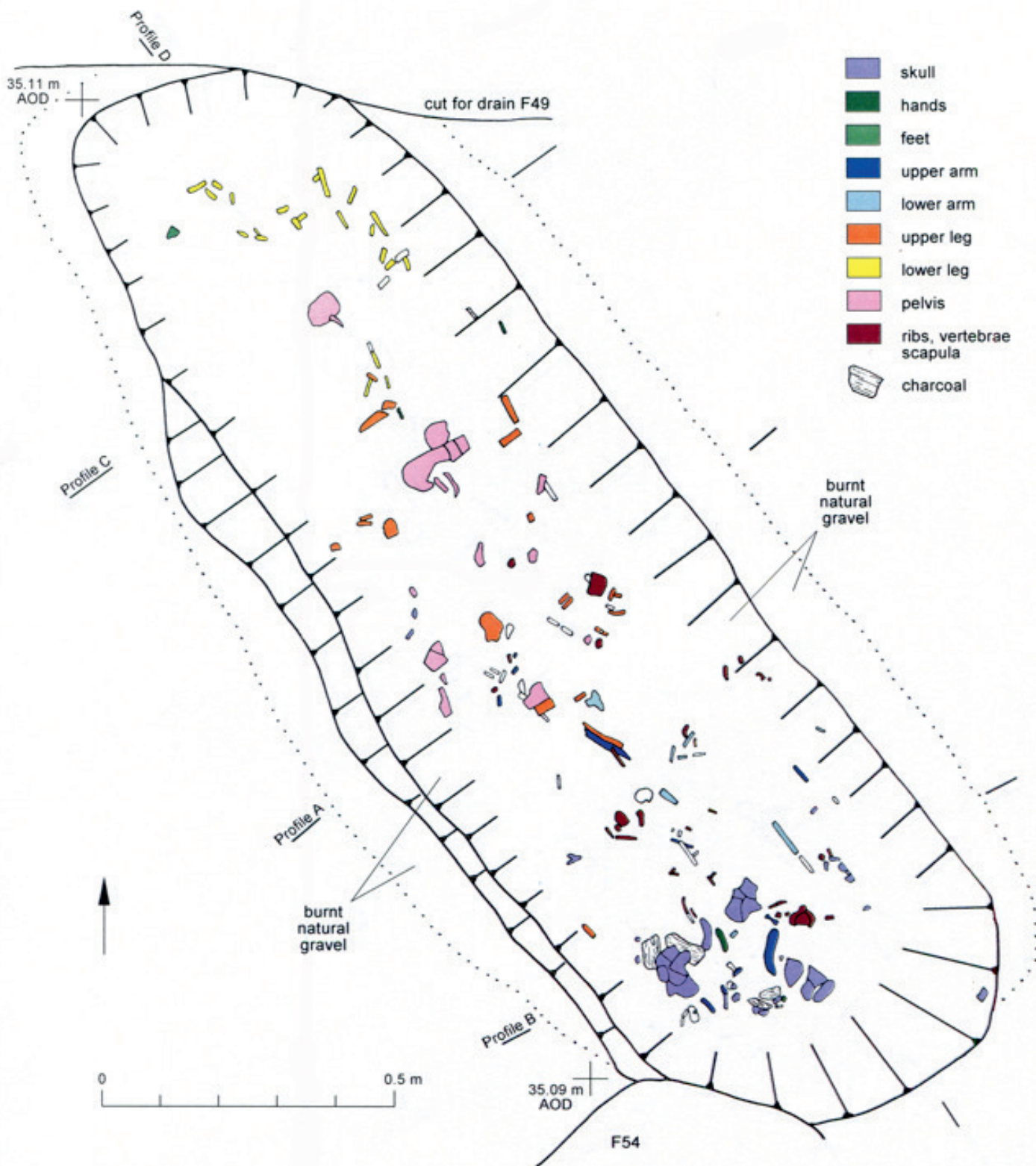


Fig 8a Bustum F47: plan, showing bone and charcoal.

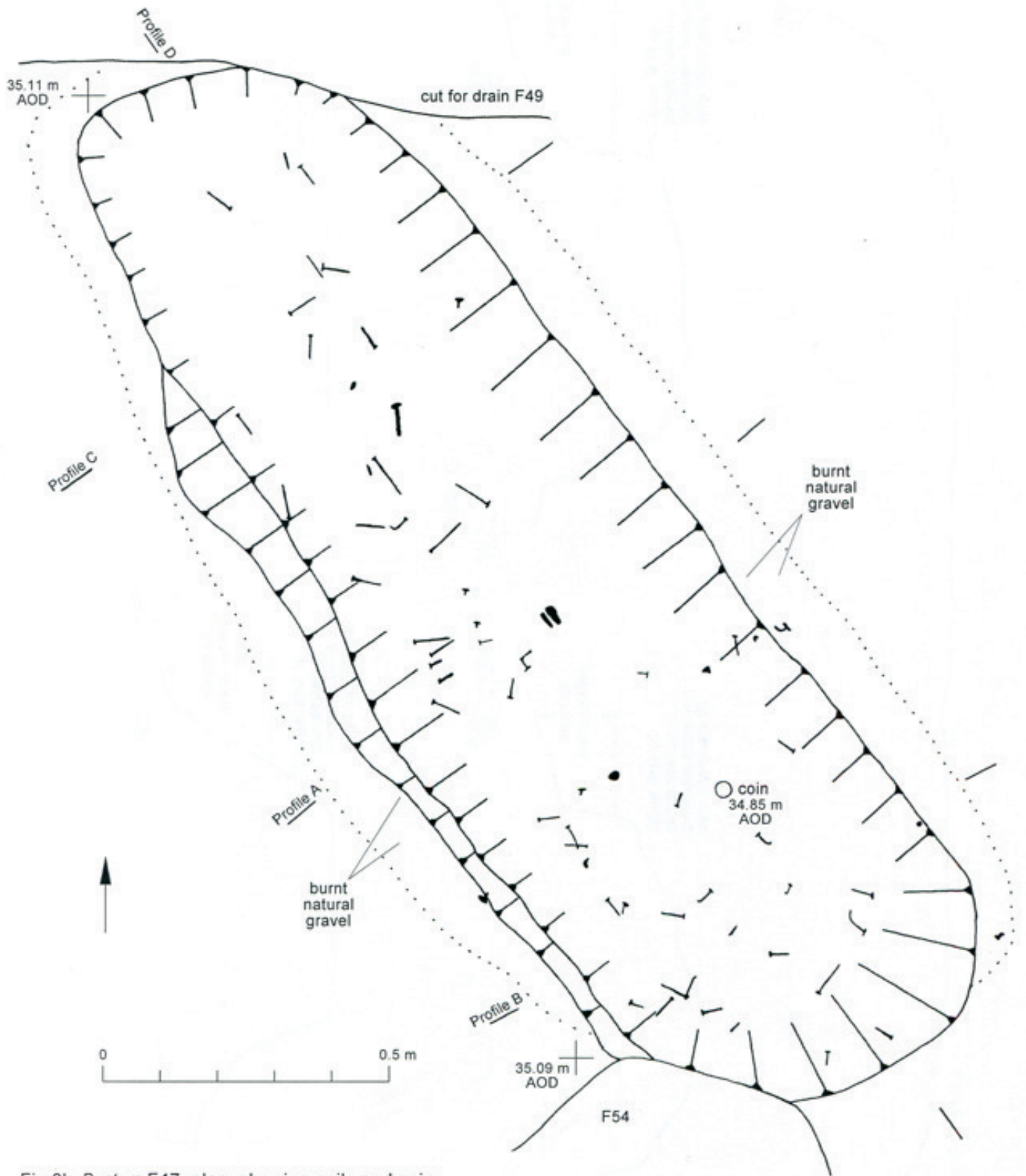


Fig 8b *Bustum* F47: plan, showing nails and coin.

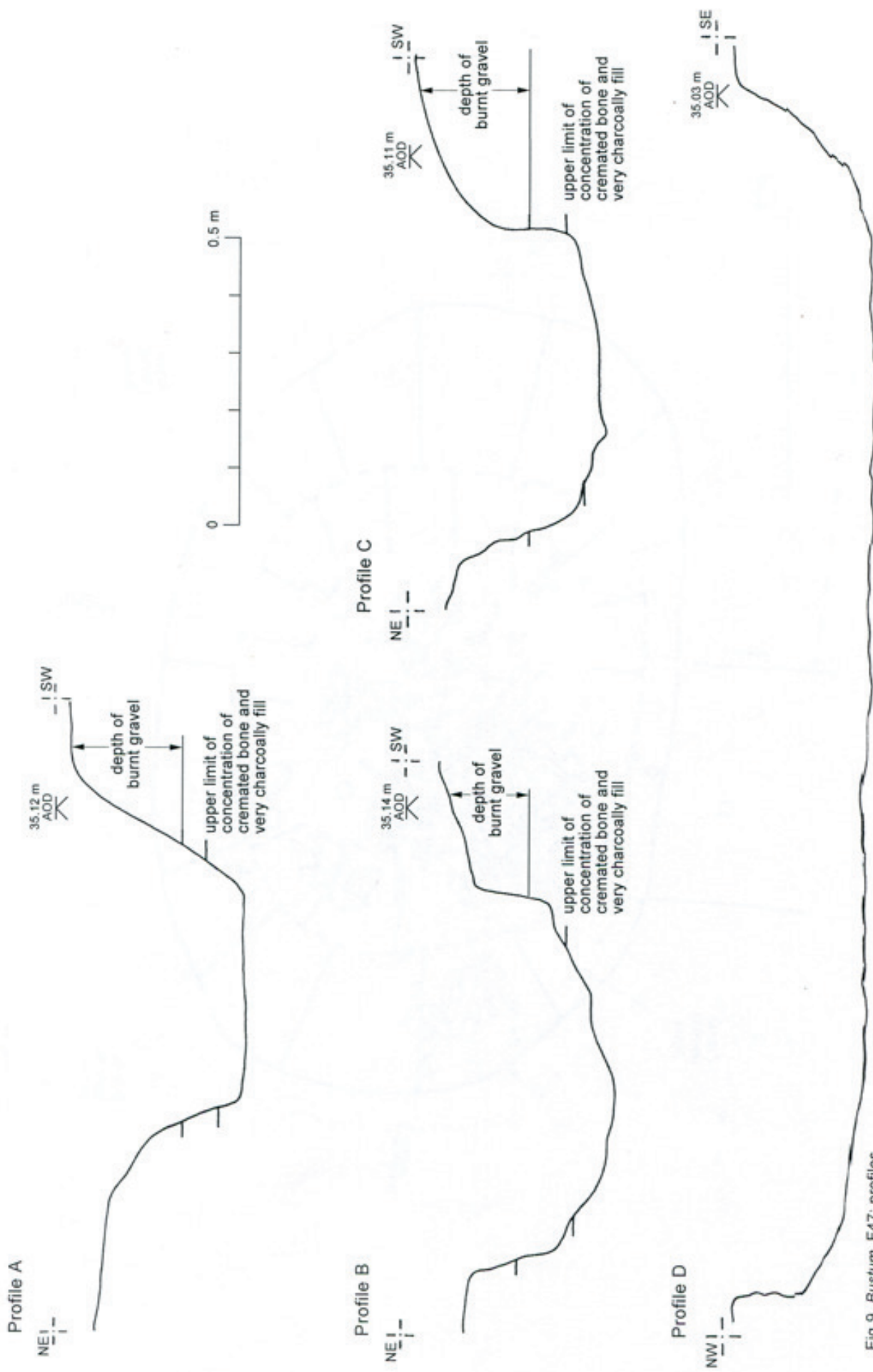


Fig 9 Bustum F47: profiles.

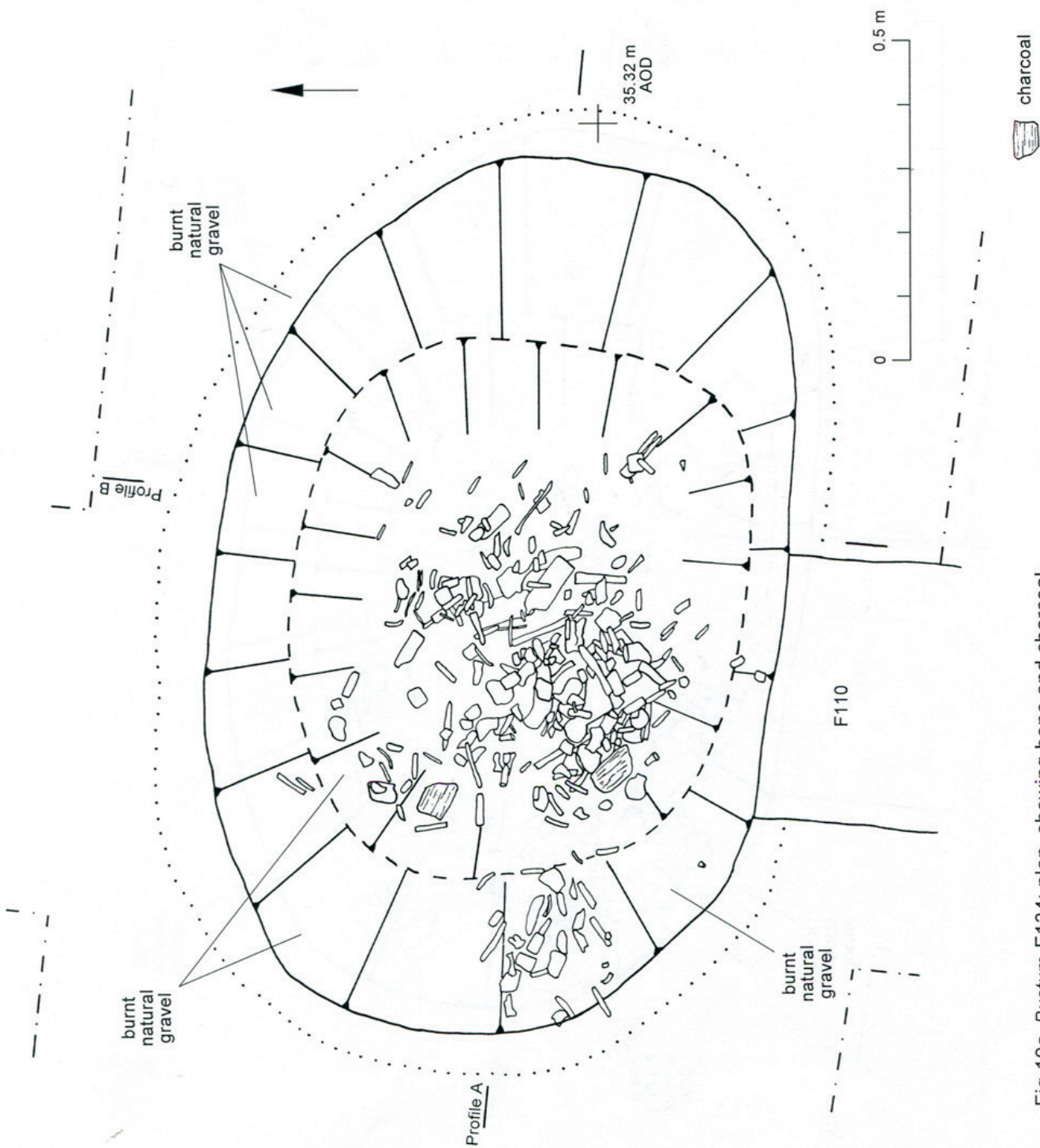


Fig 10a *Bustum* F134: plan, showing bone and charcoal.

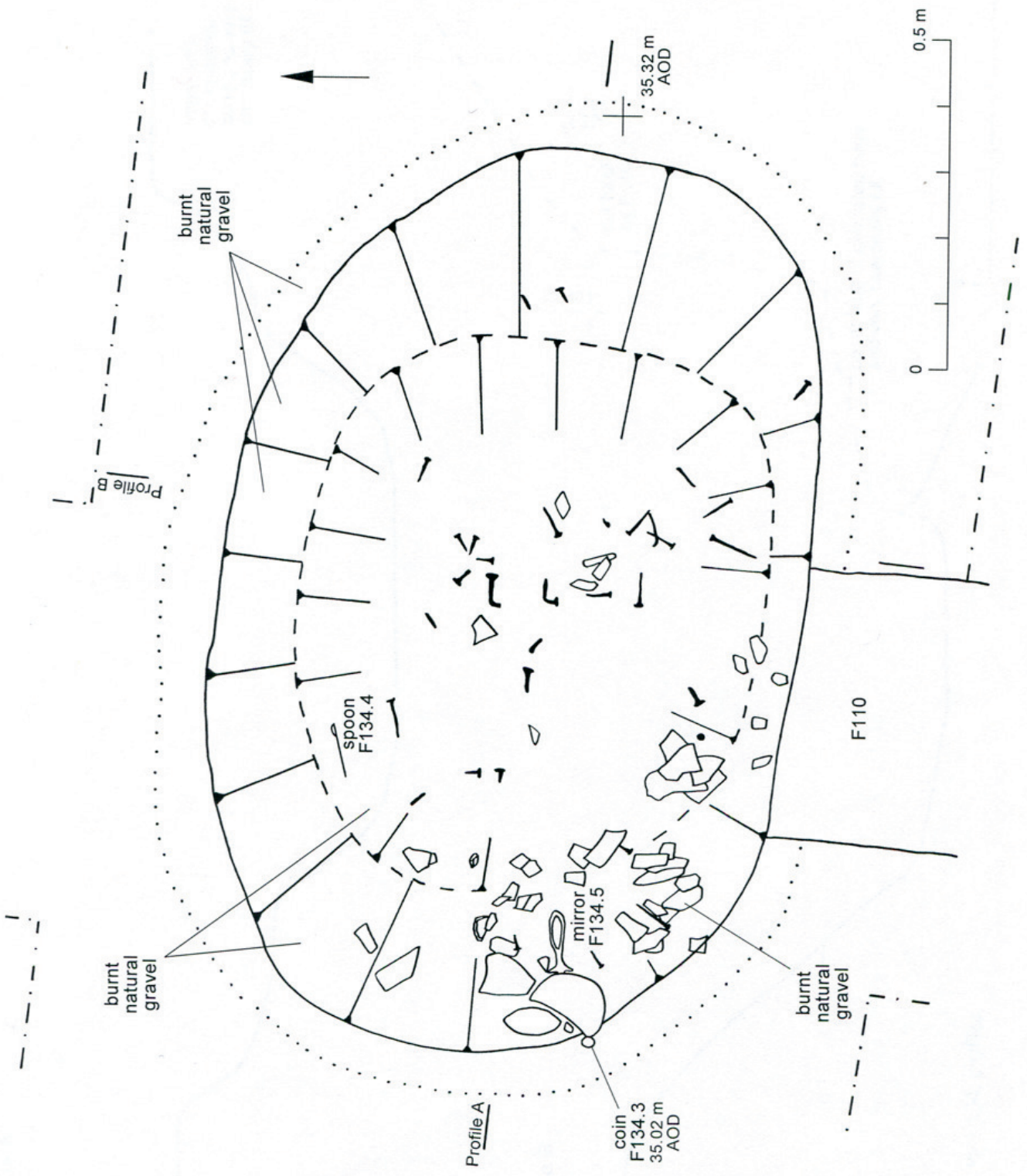
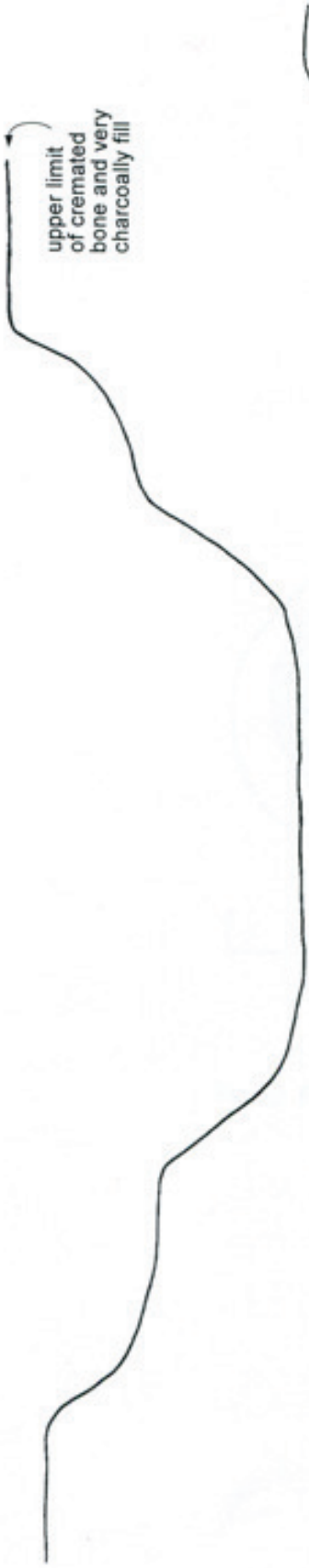


Fig 10b Bustum F134: plan, showing nails, small finds and pottery.

Profile A



35.48 m
AOD



Profile B



35.58 m
AOD



cut back
by F110

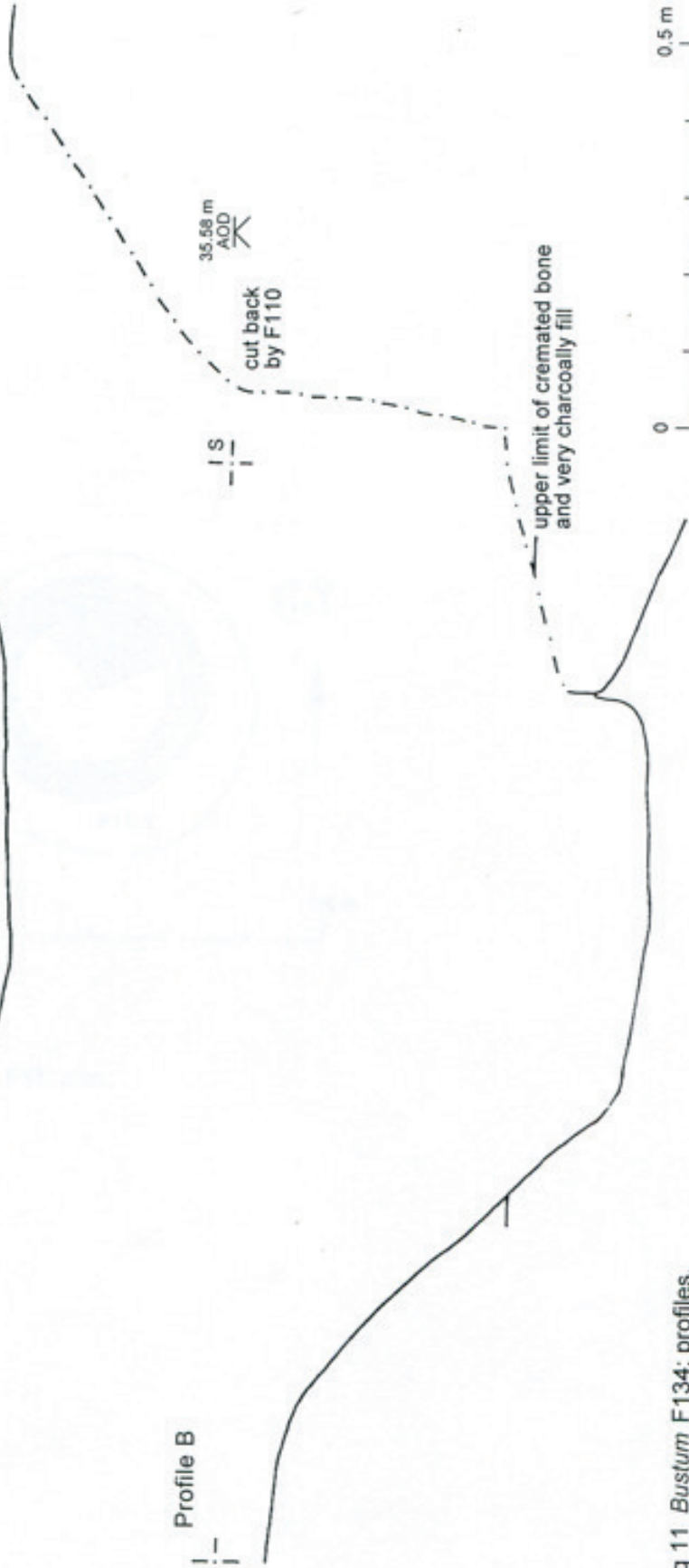
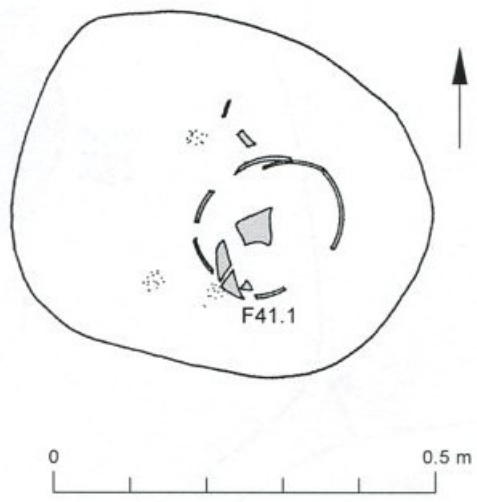
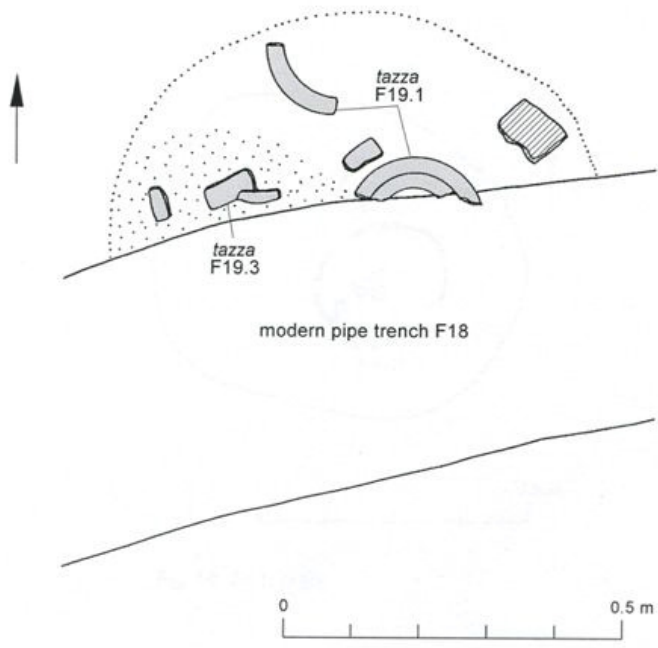
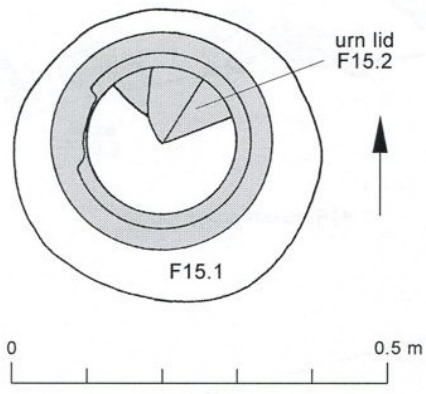


Fig 11 *Bustum* F134: profiles.



Figs 12, 13, 14: plans of F15, F19, F41

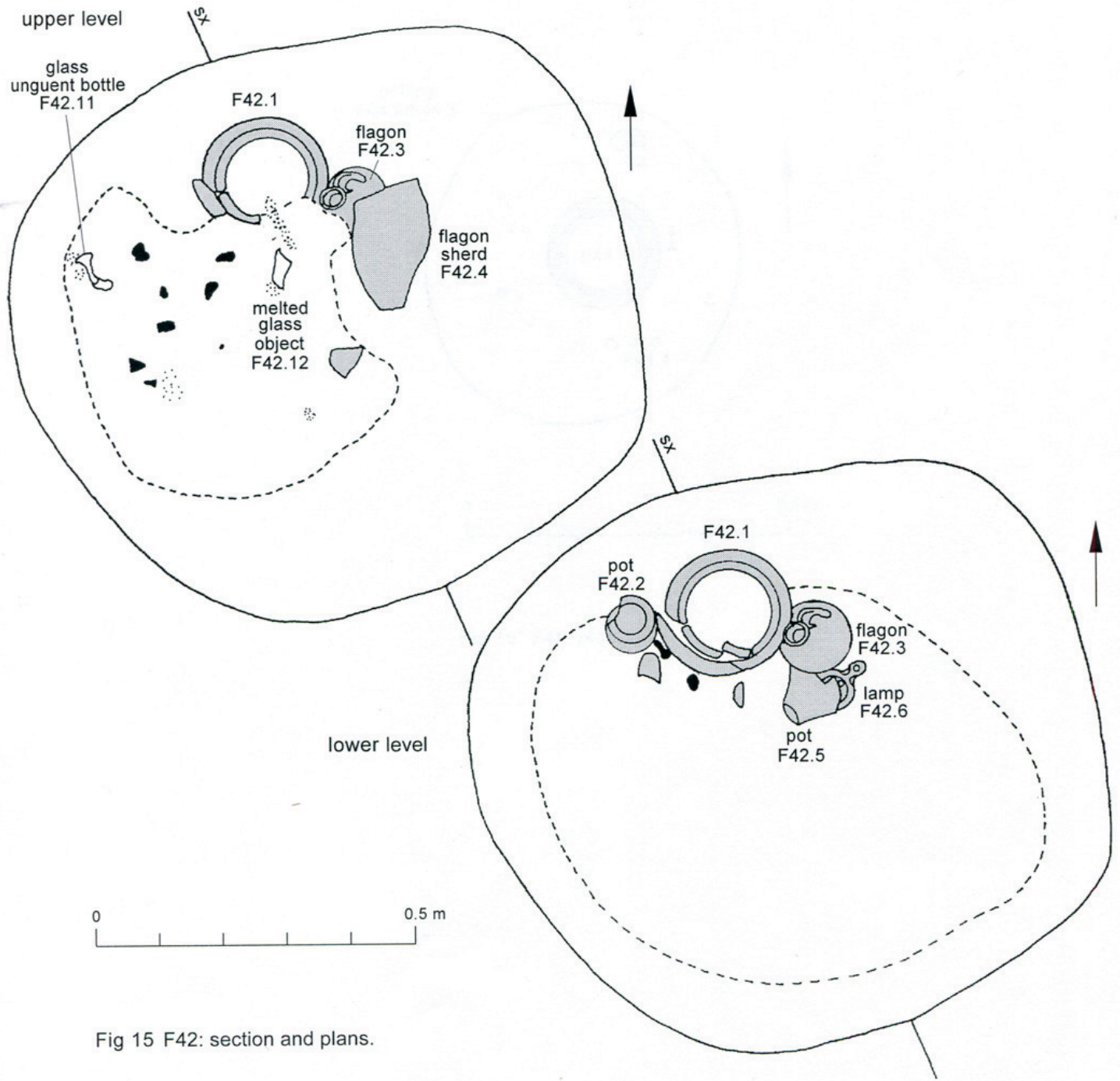
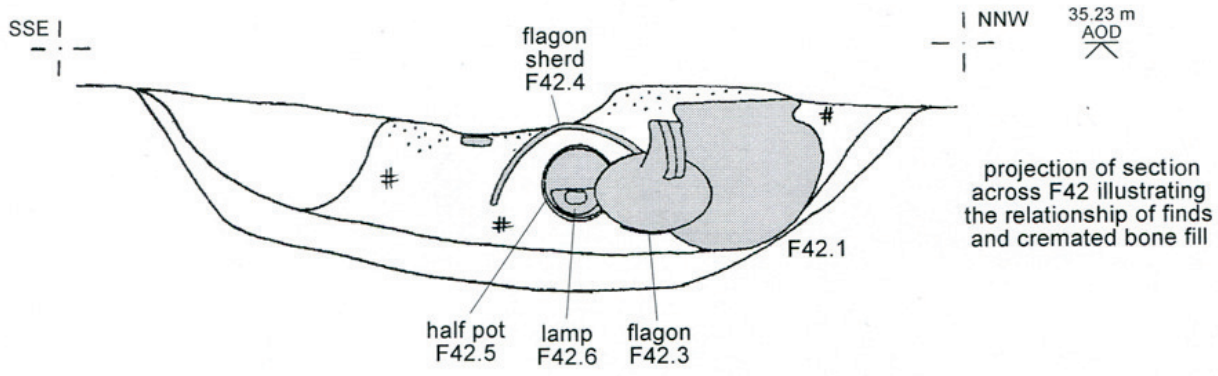


Fig 15 F42: section and plans.

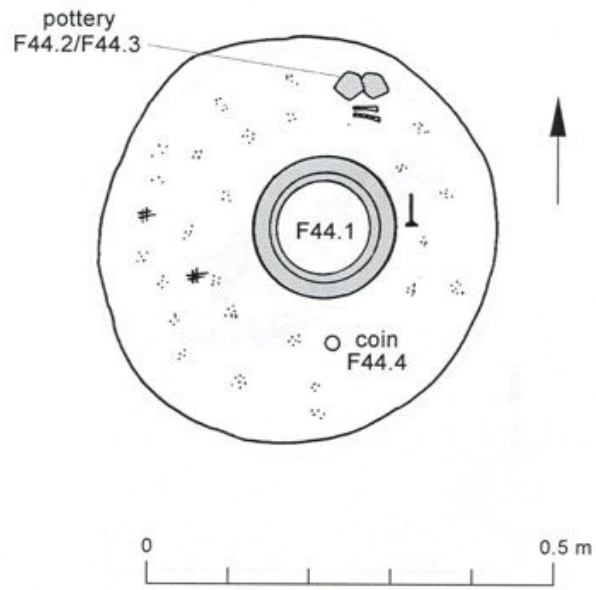


Fig 16 F44: plan.

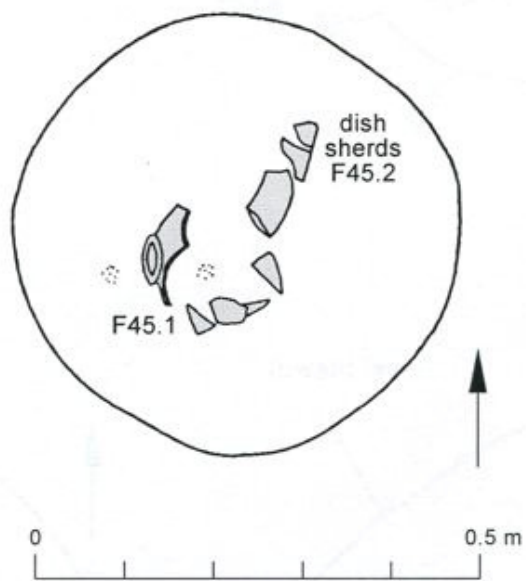
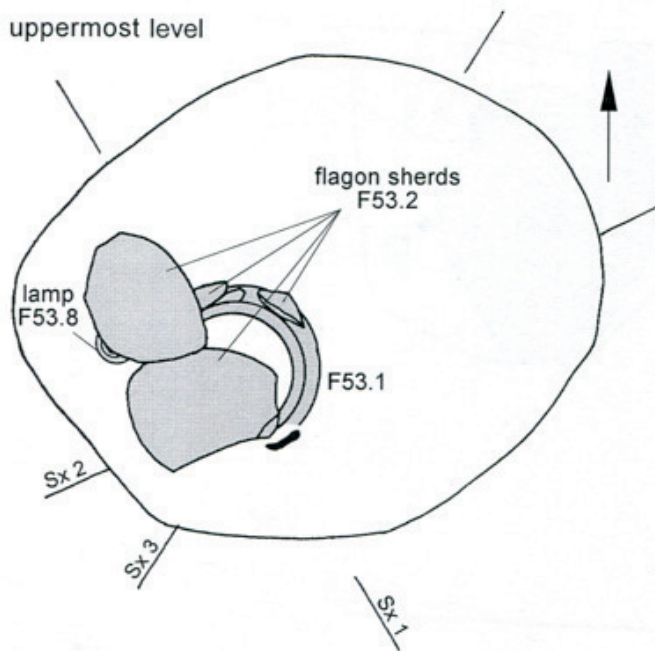


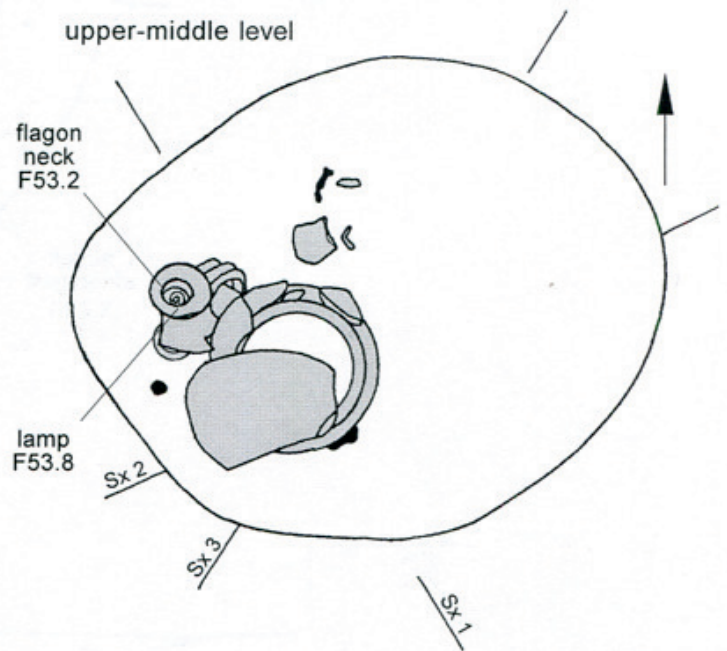
Fig 17 F45: plan.

Figs 16, 17: plans of F44, F45

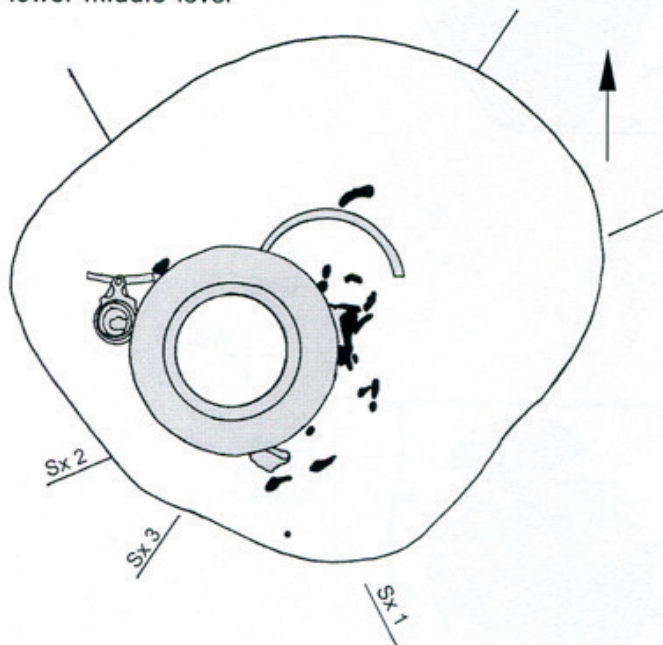
uppermost level



upper-middle level



lower-middle level



lowest level

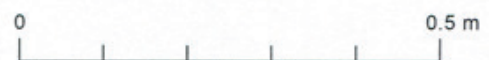
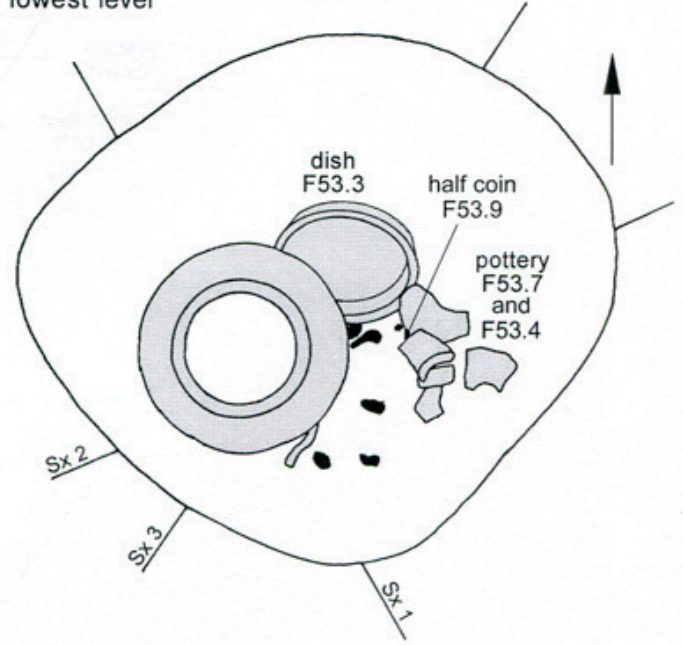


Fig 18 F53: plans.

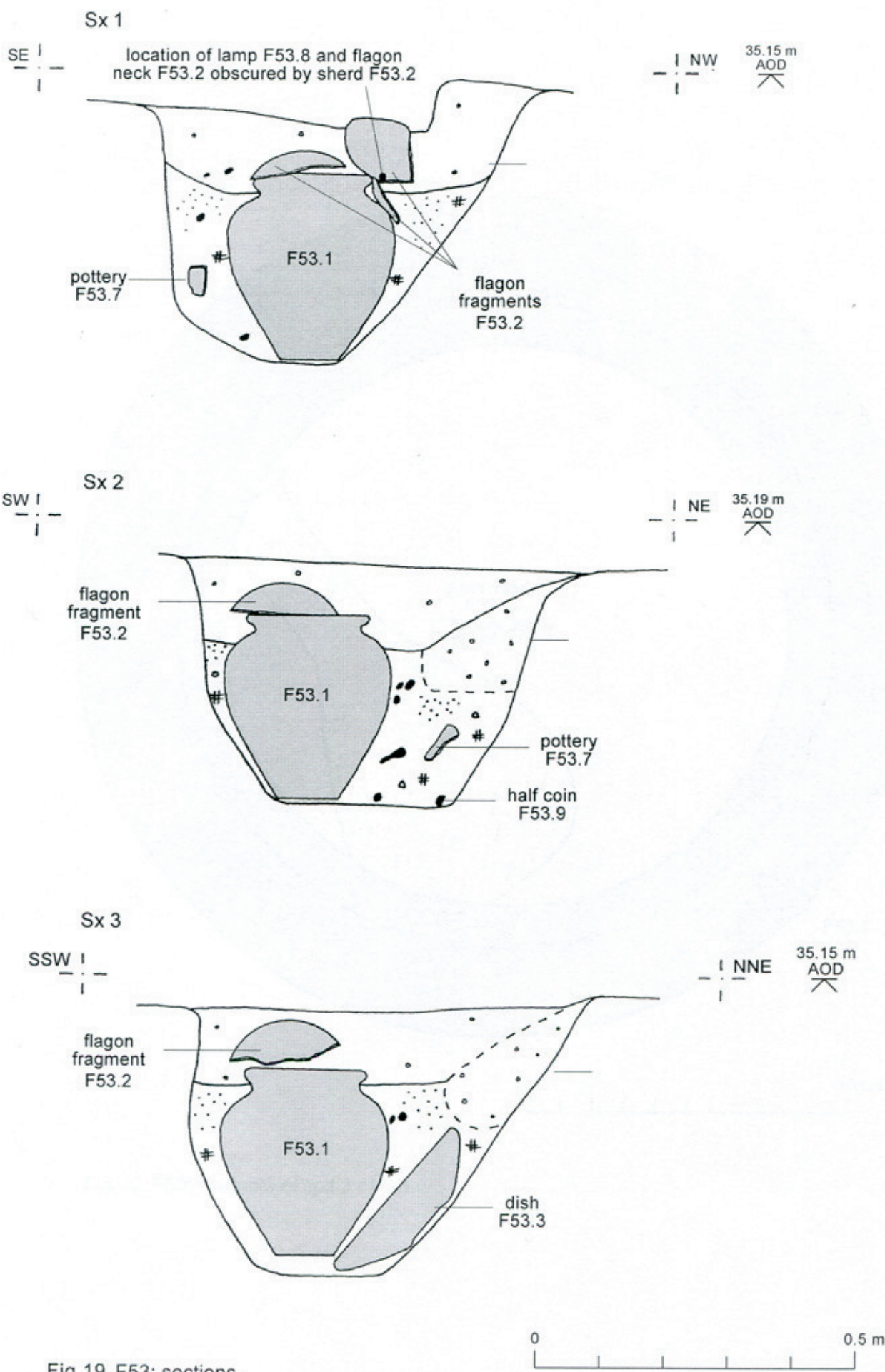


Fig 19 F53: sections.

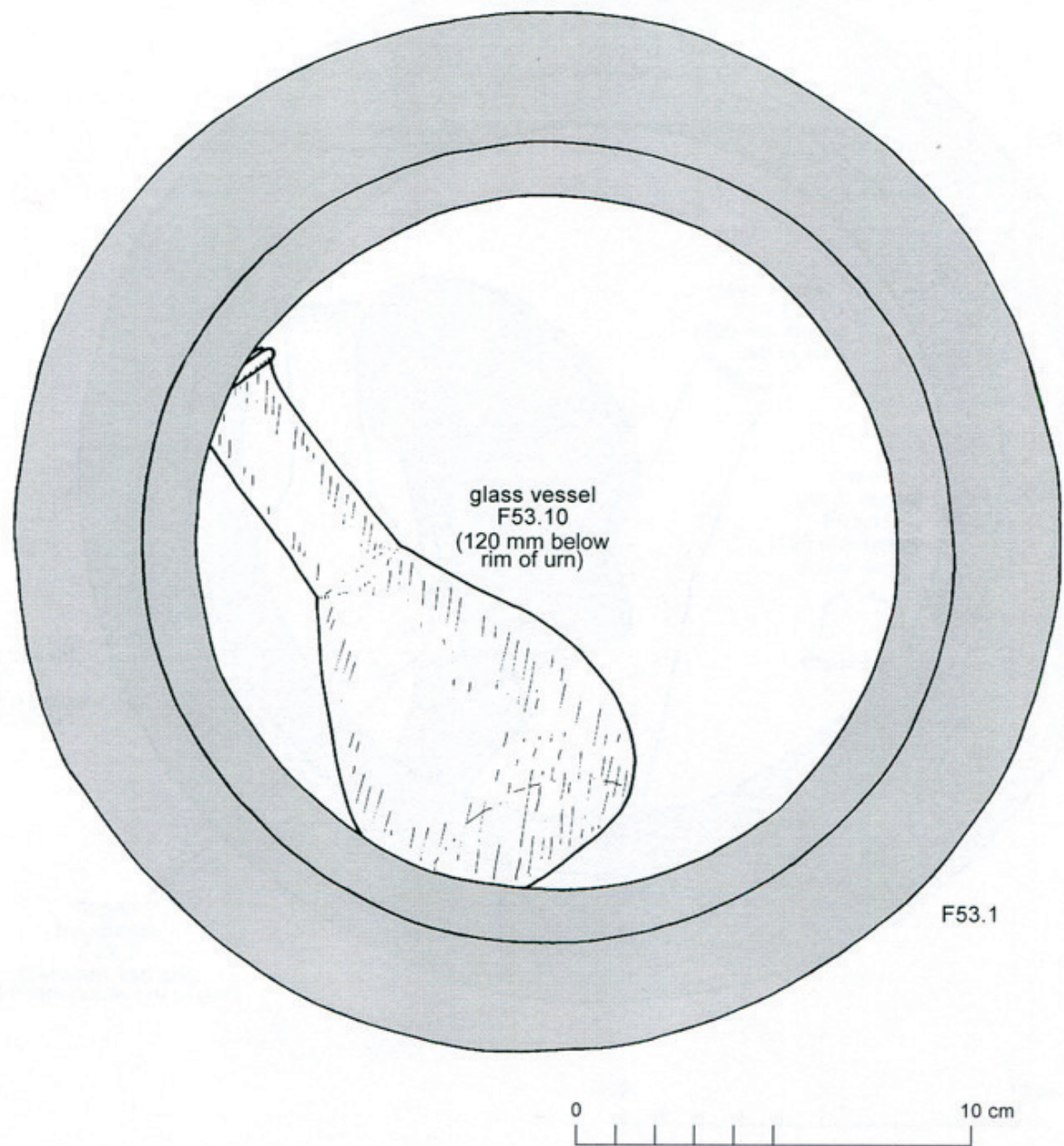


Fig 20 F53: contents of spit 3 of urn.

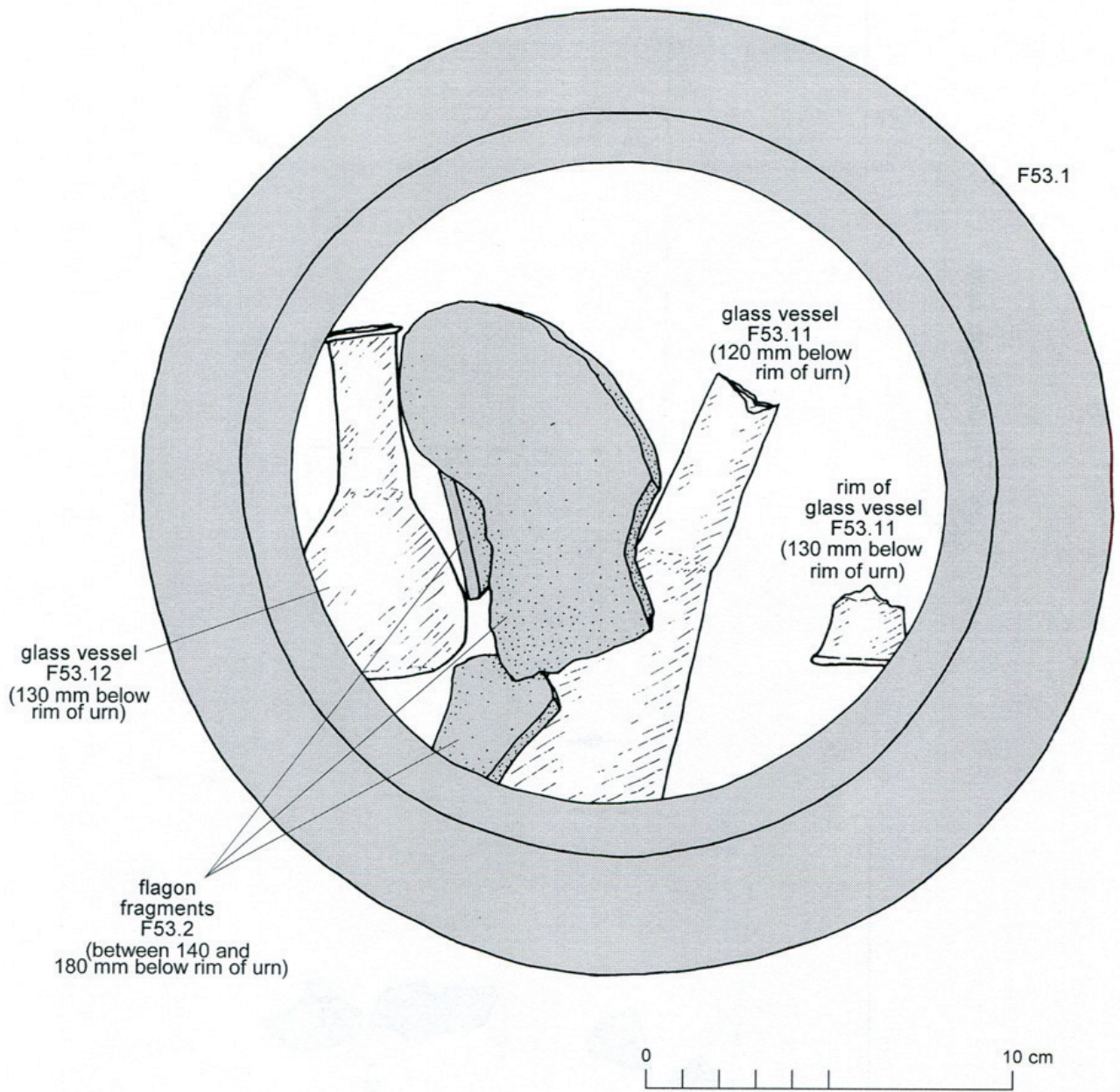


Fig 21 F53: contents of spits 4, 5, 7 of urn.

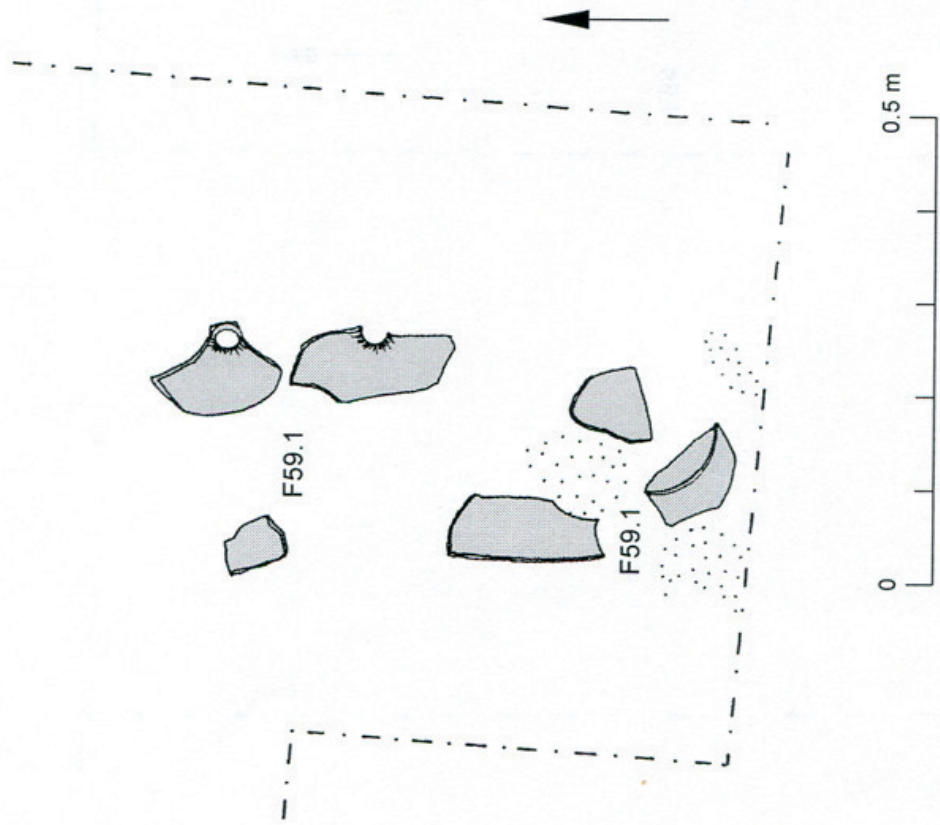


Fig 22 F59: plan.

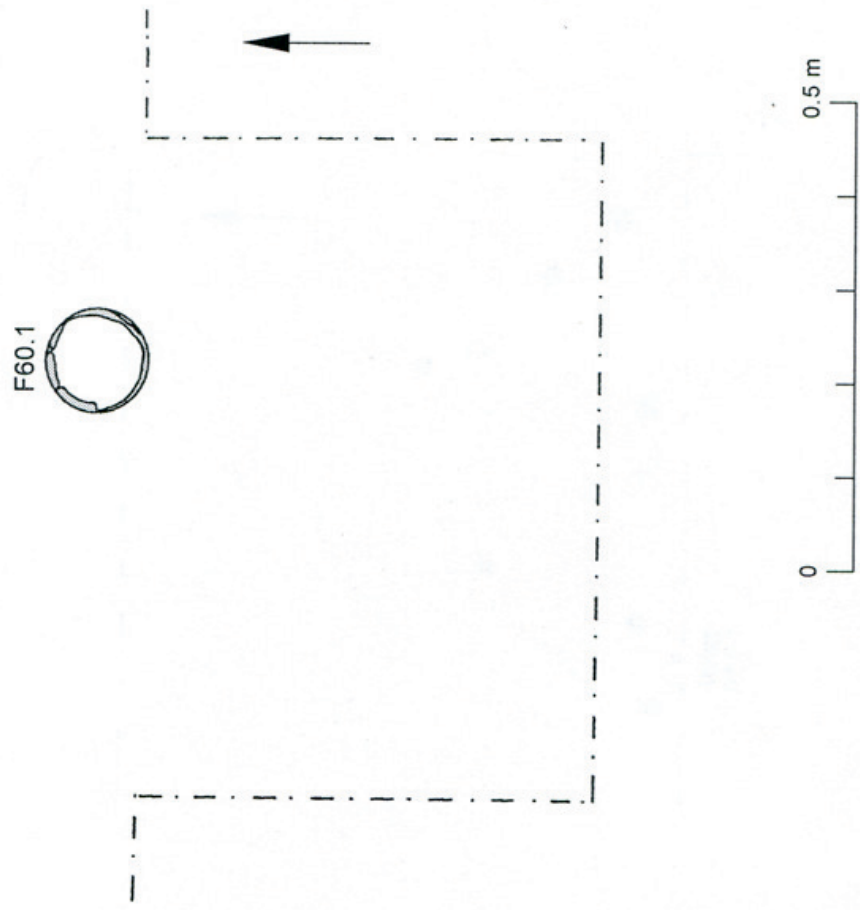


Fig 23 F60: plan.

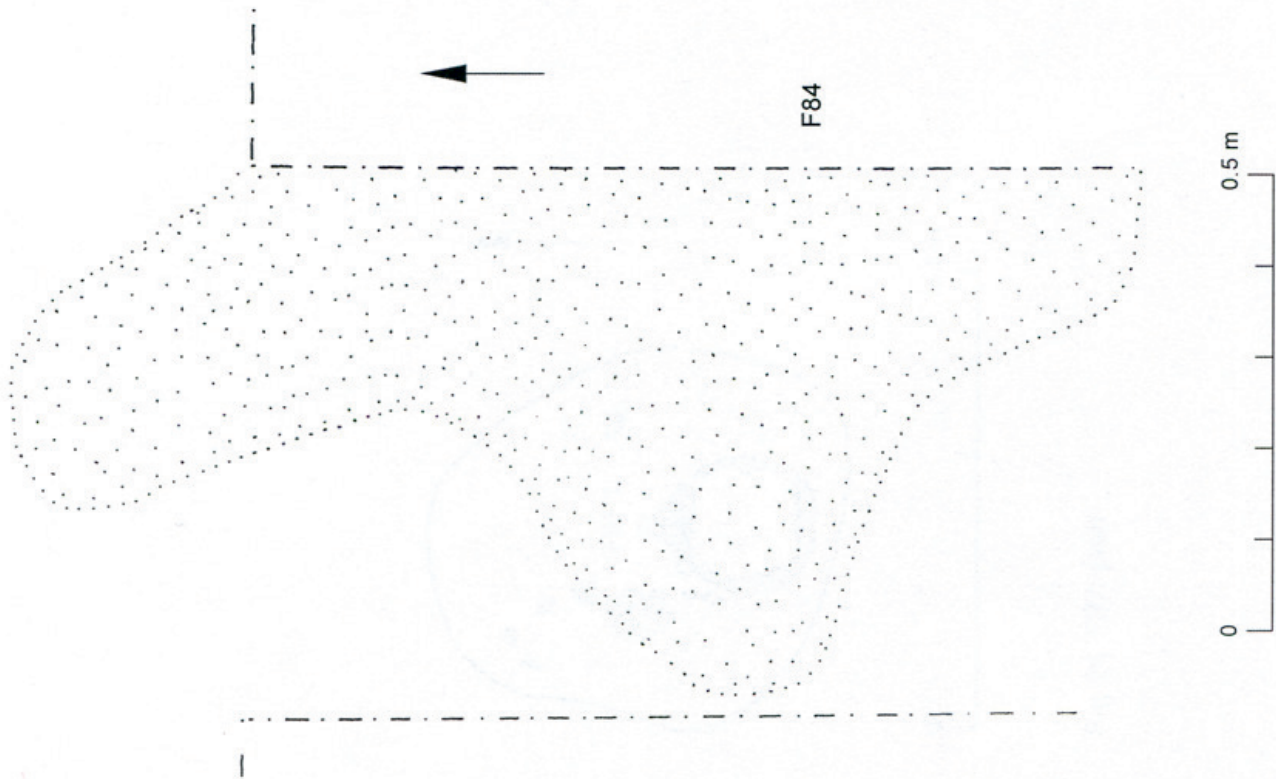


Fig 24 F84: plan.

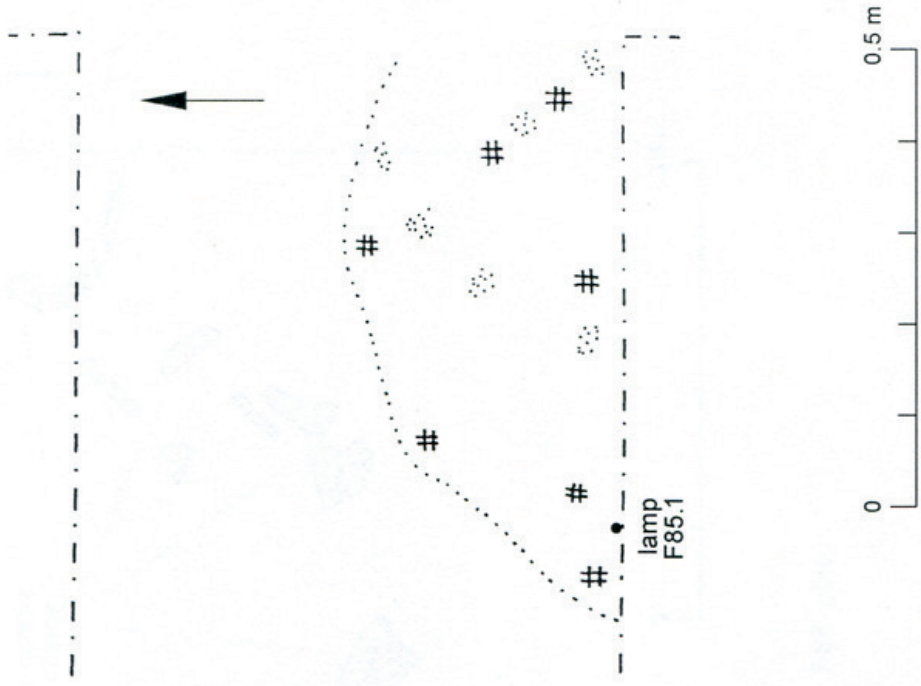


Fig 25 F85: plan.

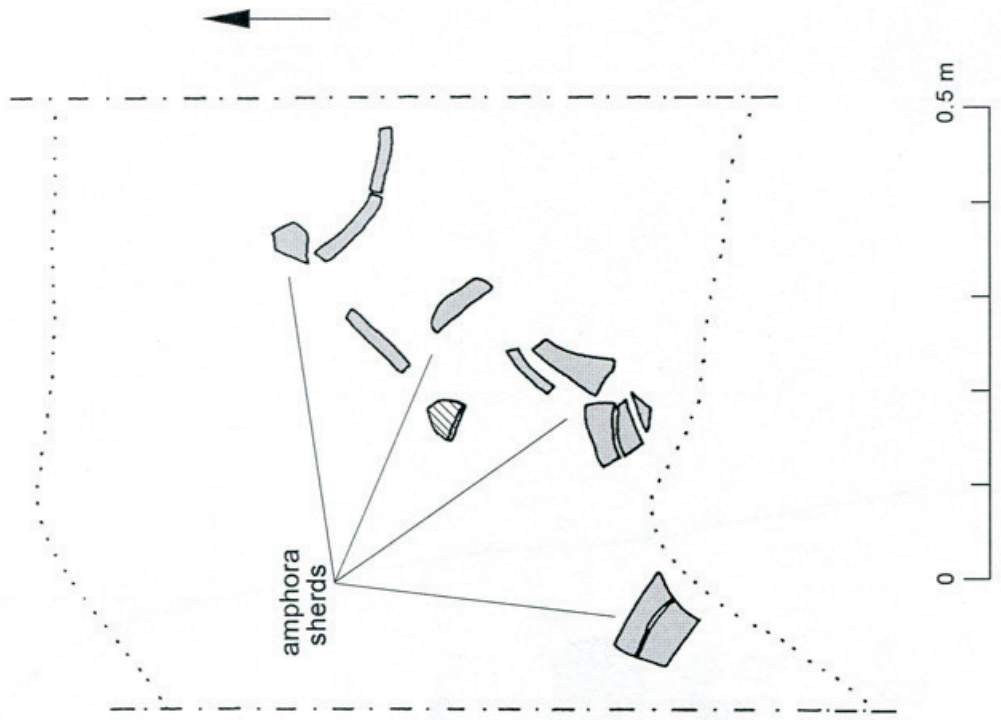


Fig 27 F88: plan.

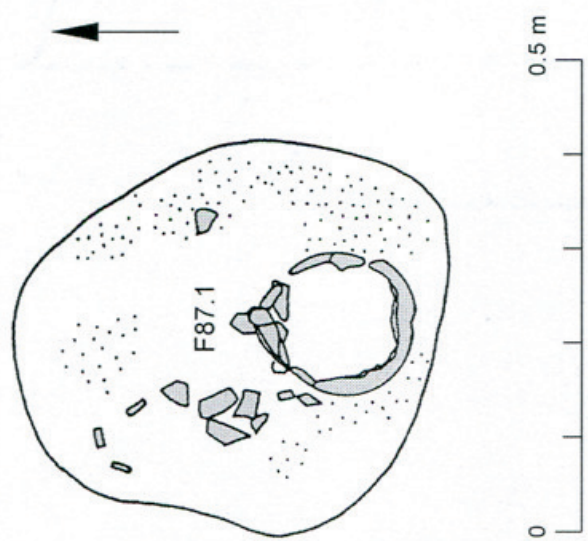


Fig 26 F87: plan.

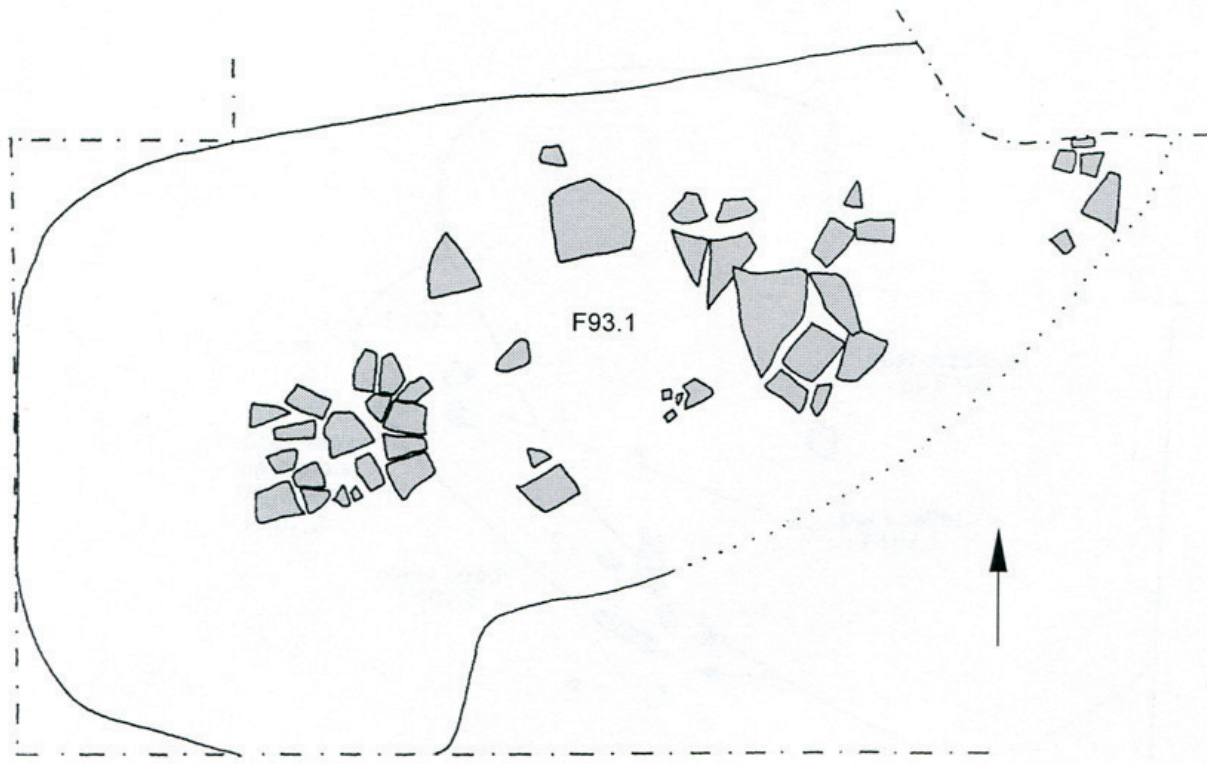
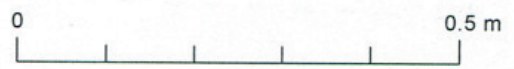


Fig 28 F93: plan.



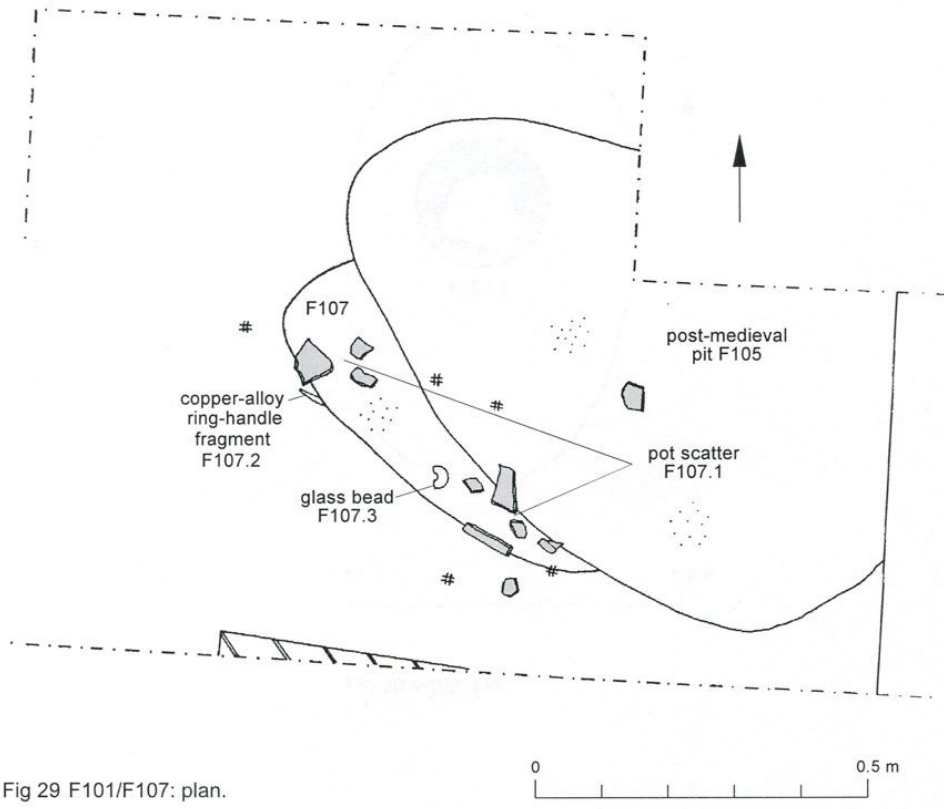


Fig 29 F101/F107: plan.

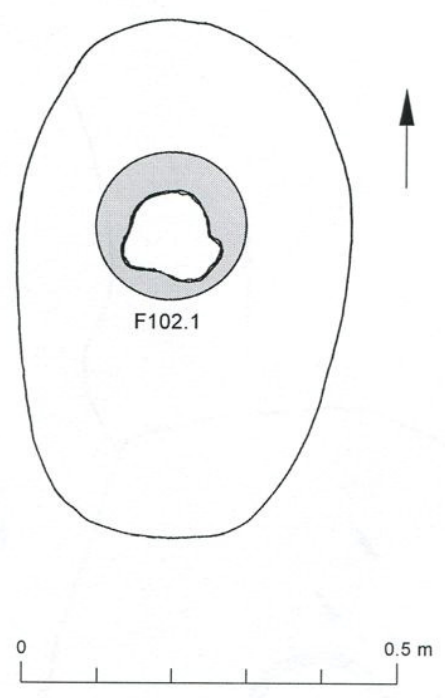


Fig 30 F102: plan.

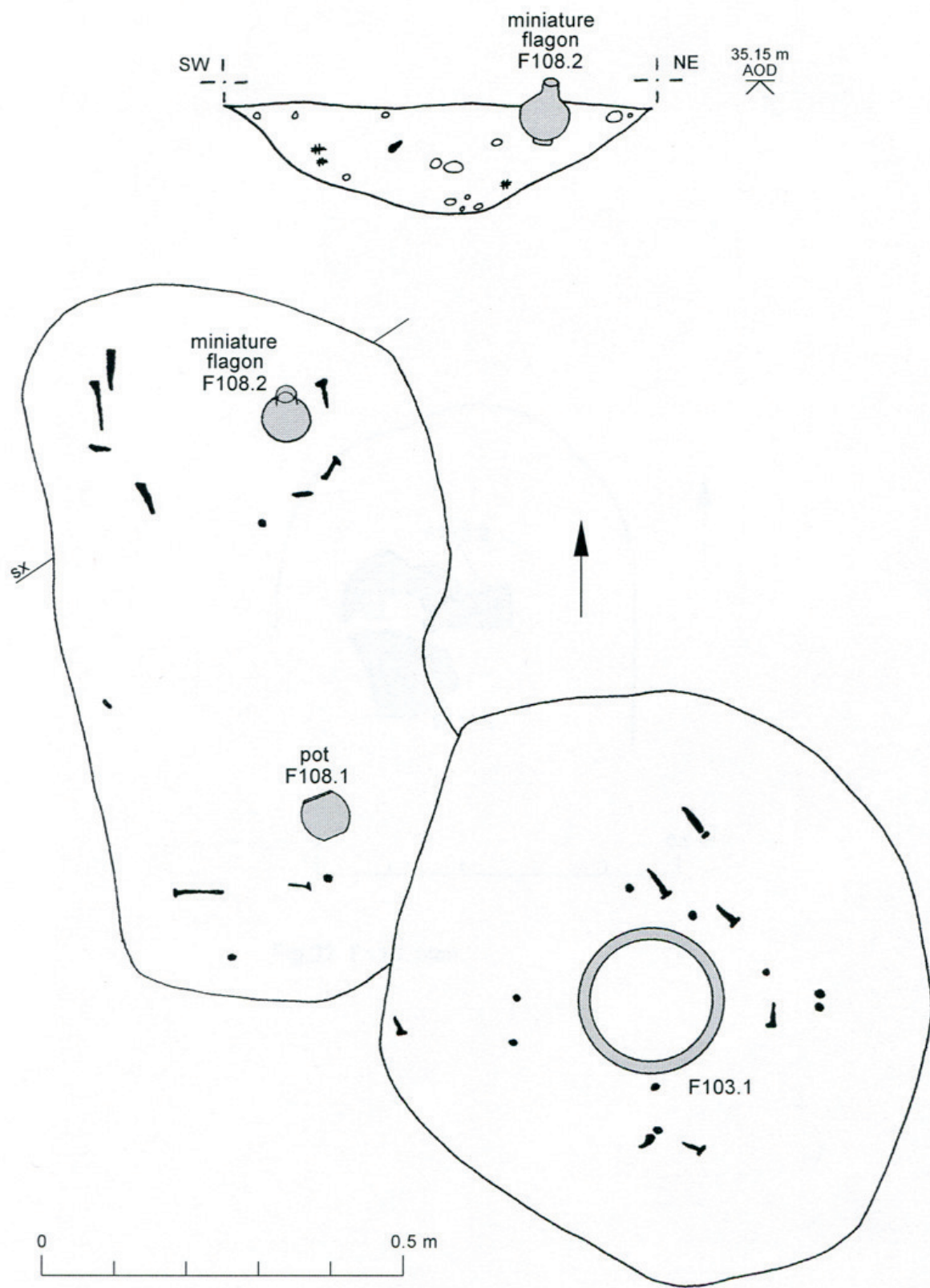


Fig 31 F108: section and plan, F103: plan.

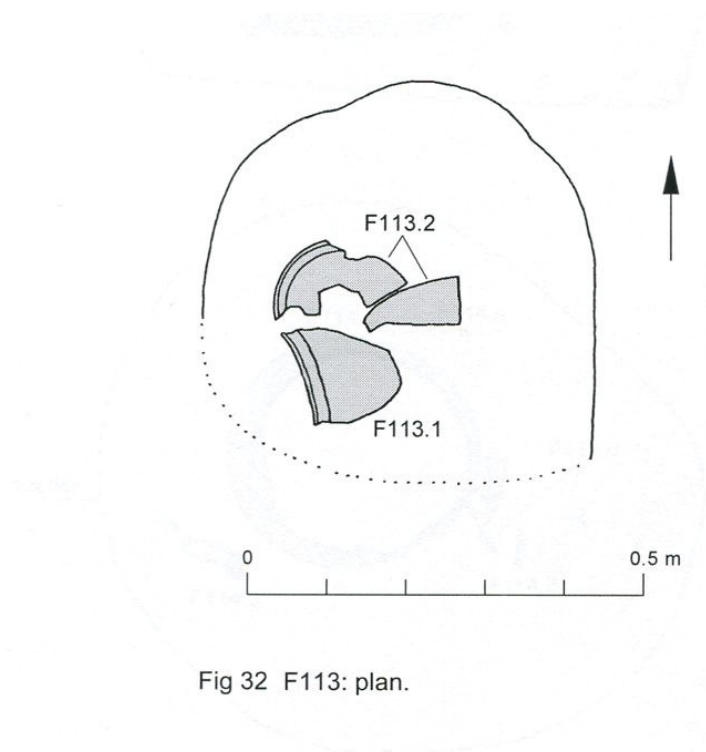


Fig 32 F113: plan.

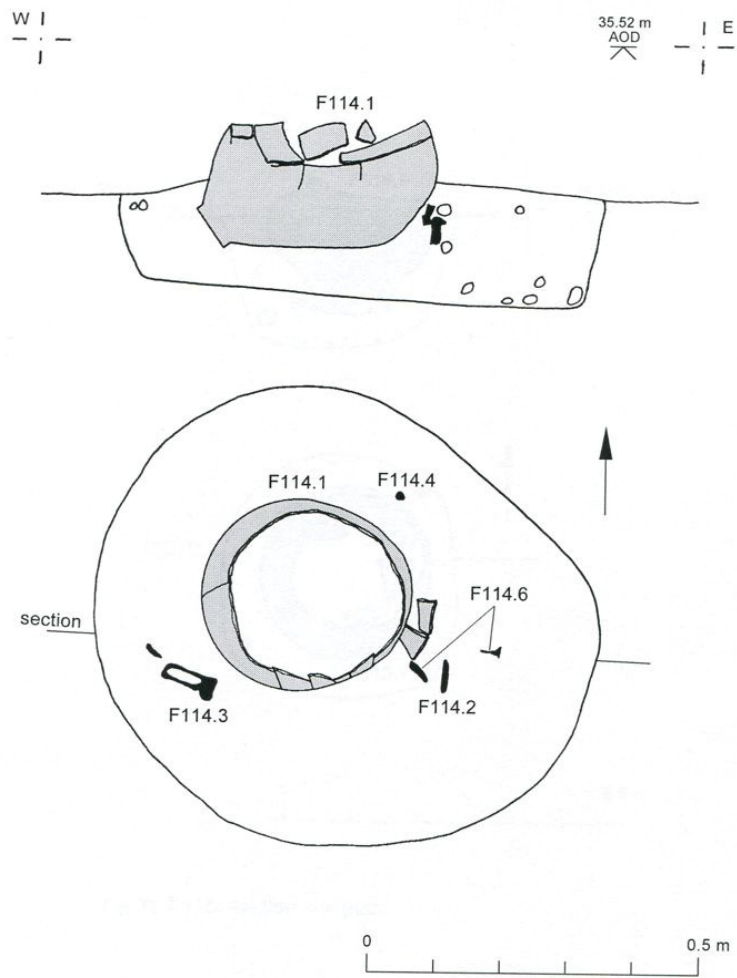


Fig 33 F114: section and plan.

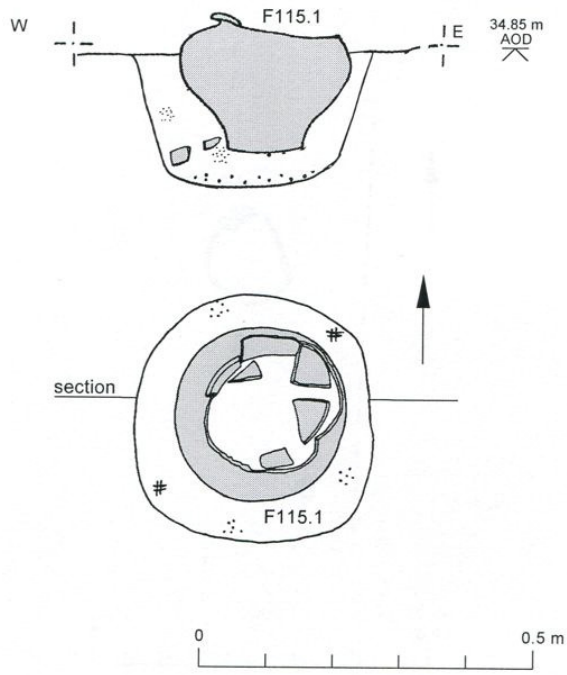


Fig 34 F115: section and plan.

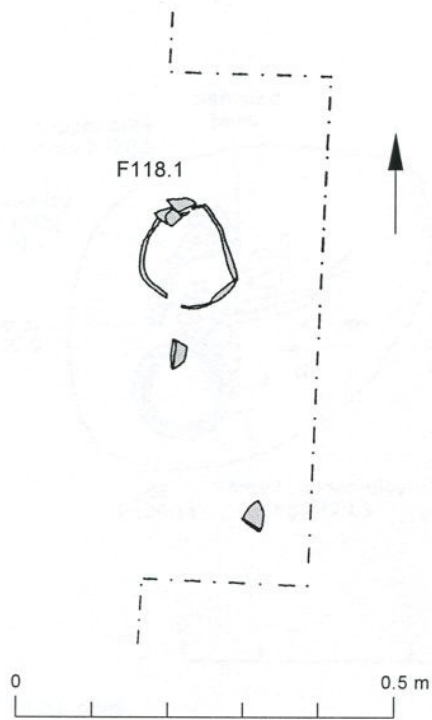


Fig 35 F118: plan.

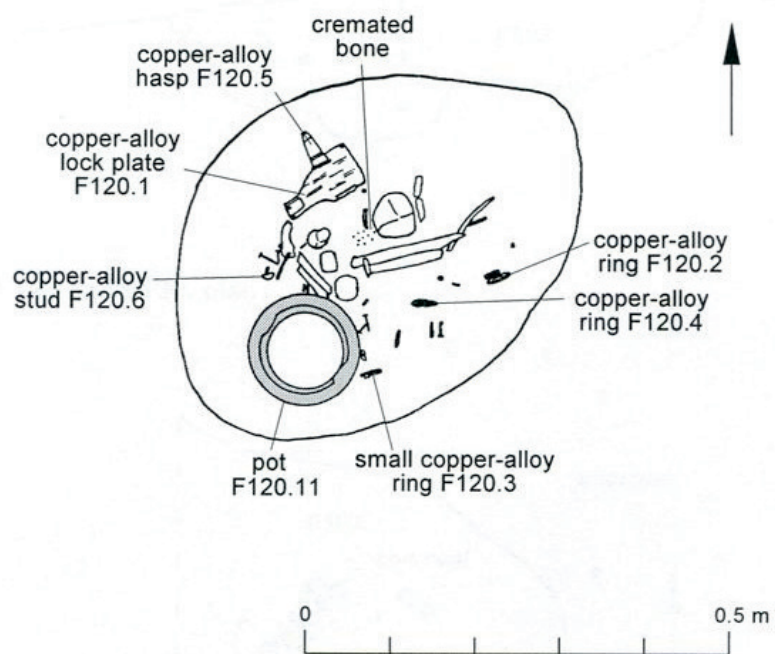
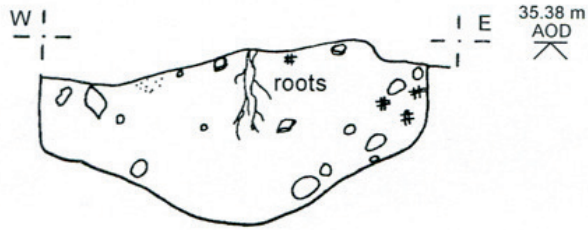
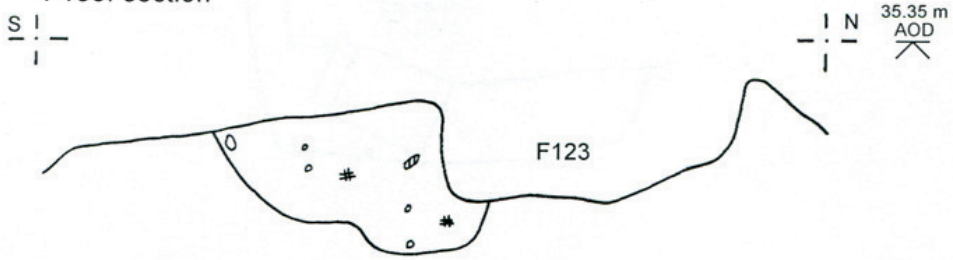


Fig 36 F120: plan.

F123: section



F130: section



F123 and F130: plan

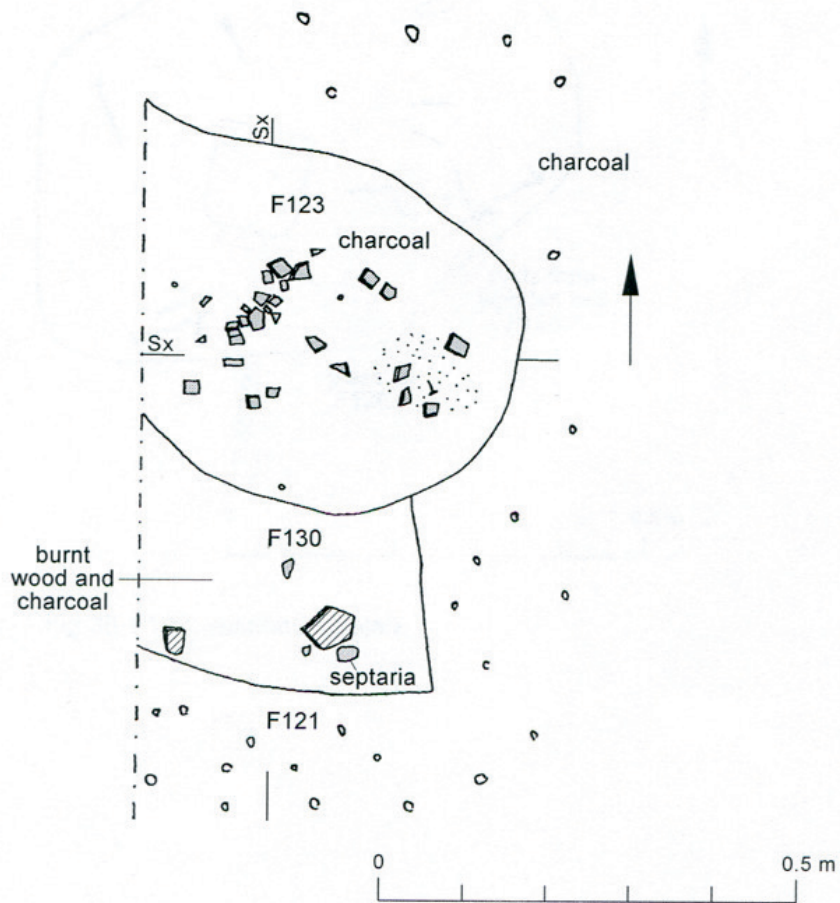


Fig 37 F123 and F130: sections and plan.

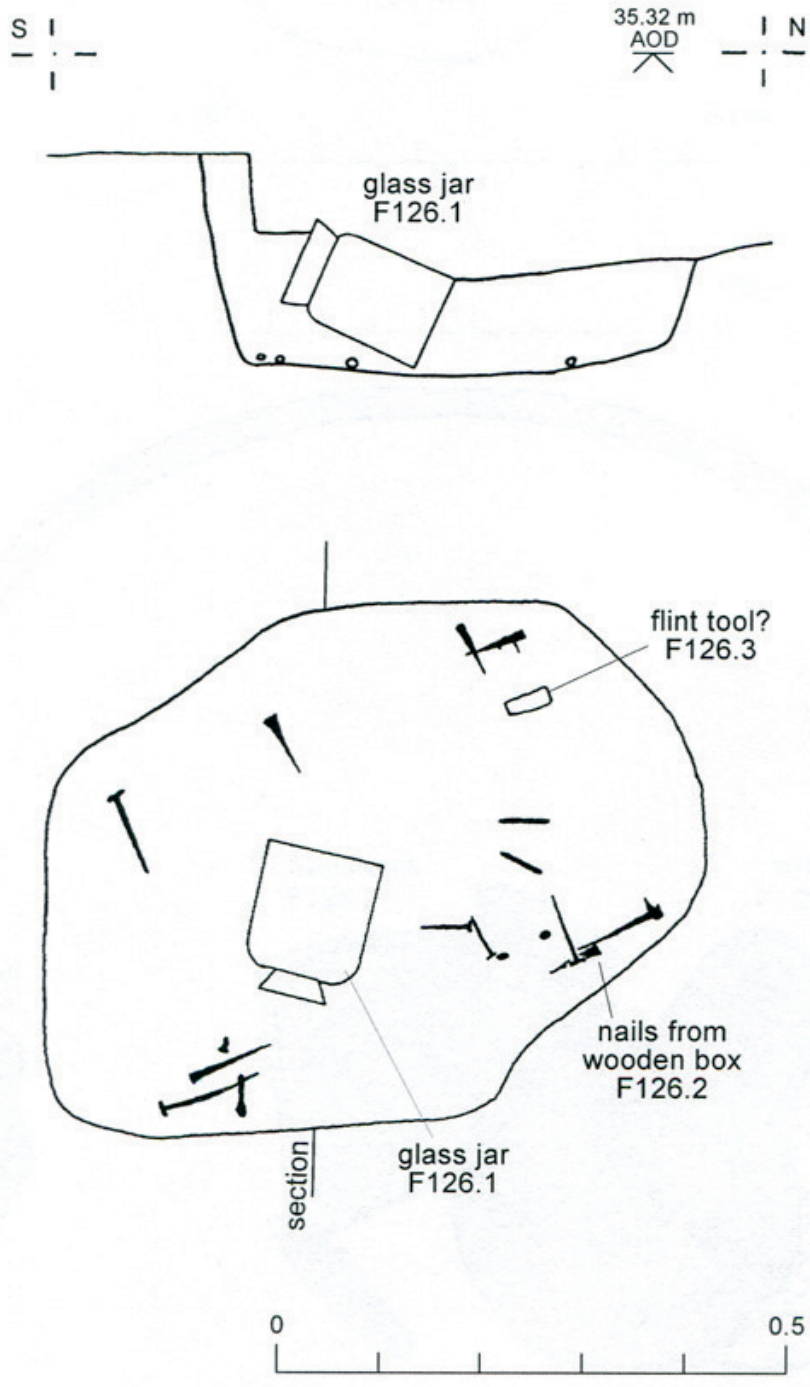


Fig 38 F126: section and plan.

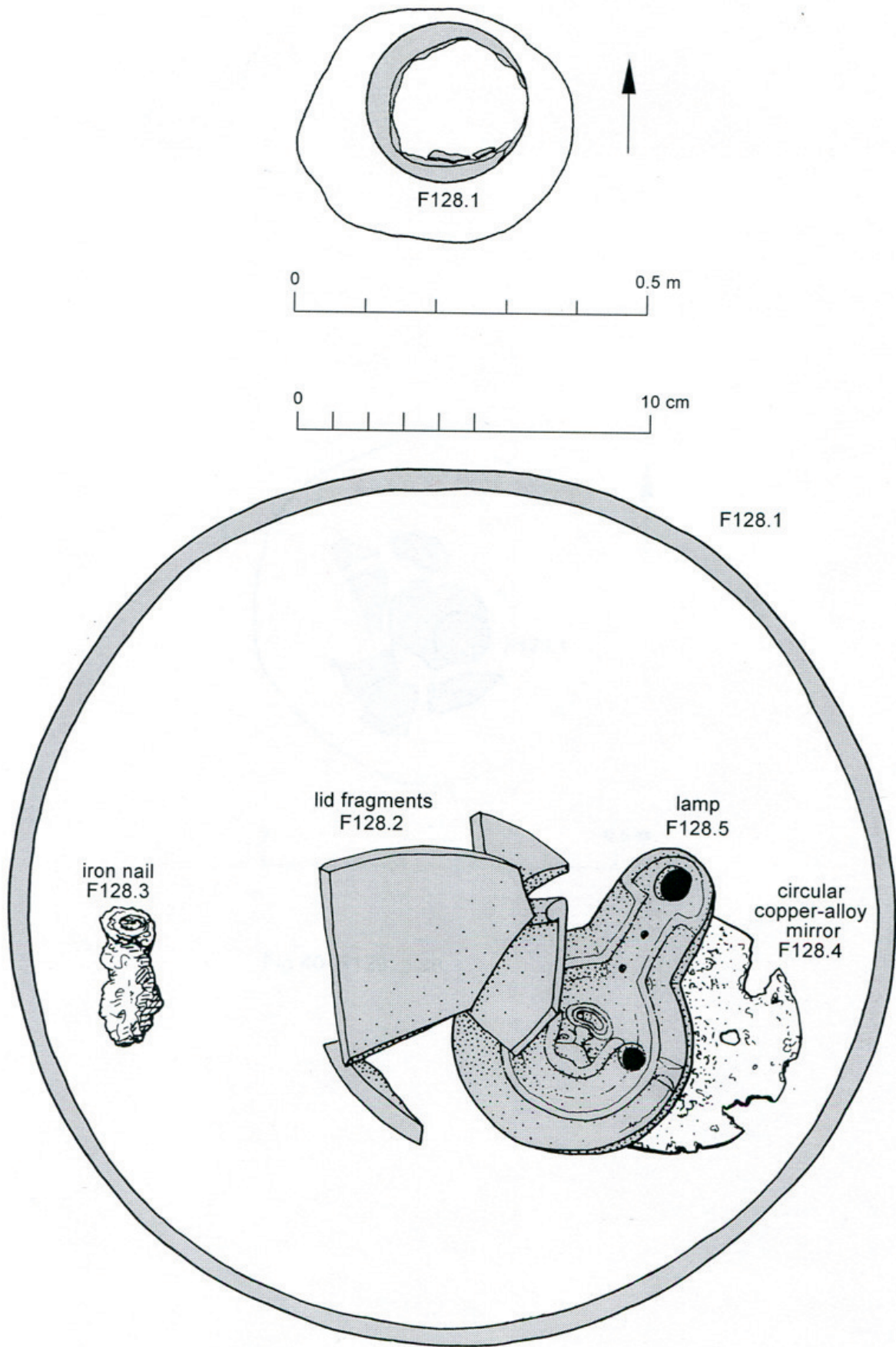


Fig 39 F128: plan and contents of spits 2, 5 and 8 of urn.

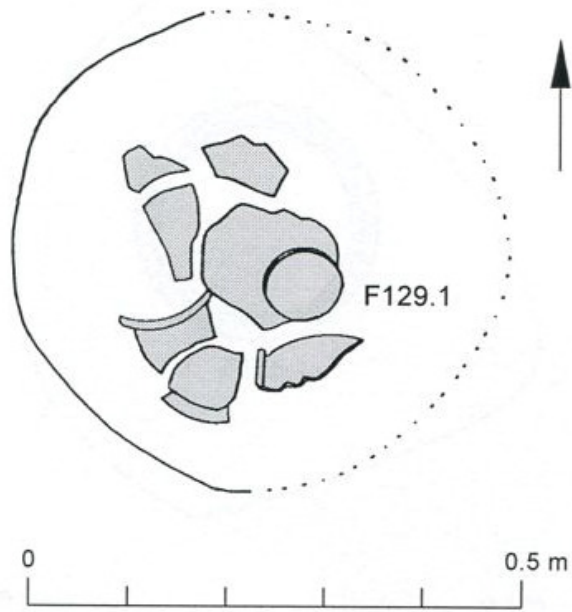


Fig 40 F129: plan.

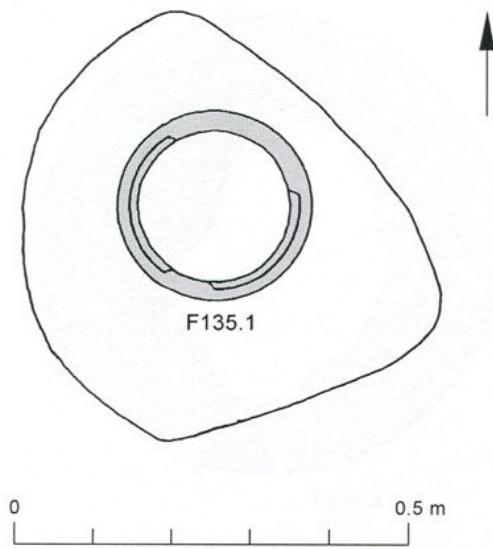


Fig 41 F135: plan.

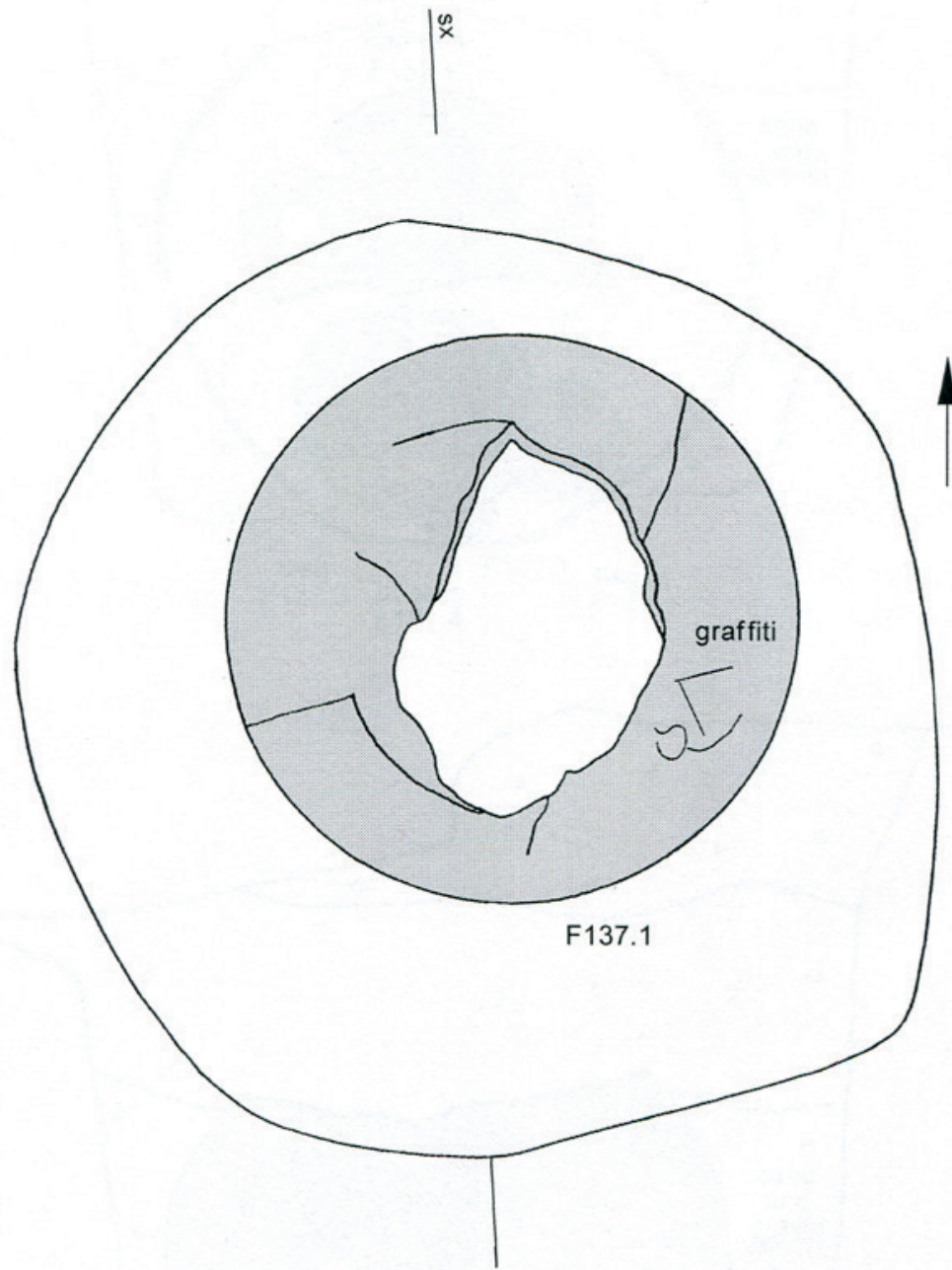


Fig 42 F137: plan.



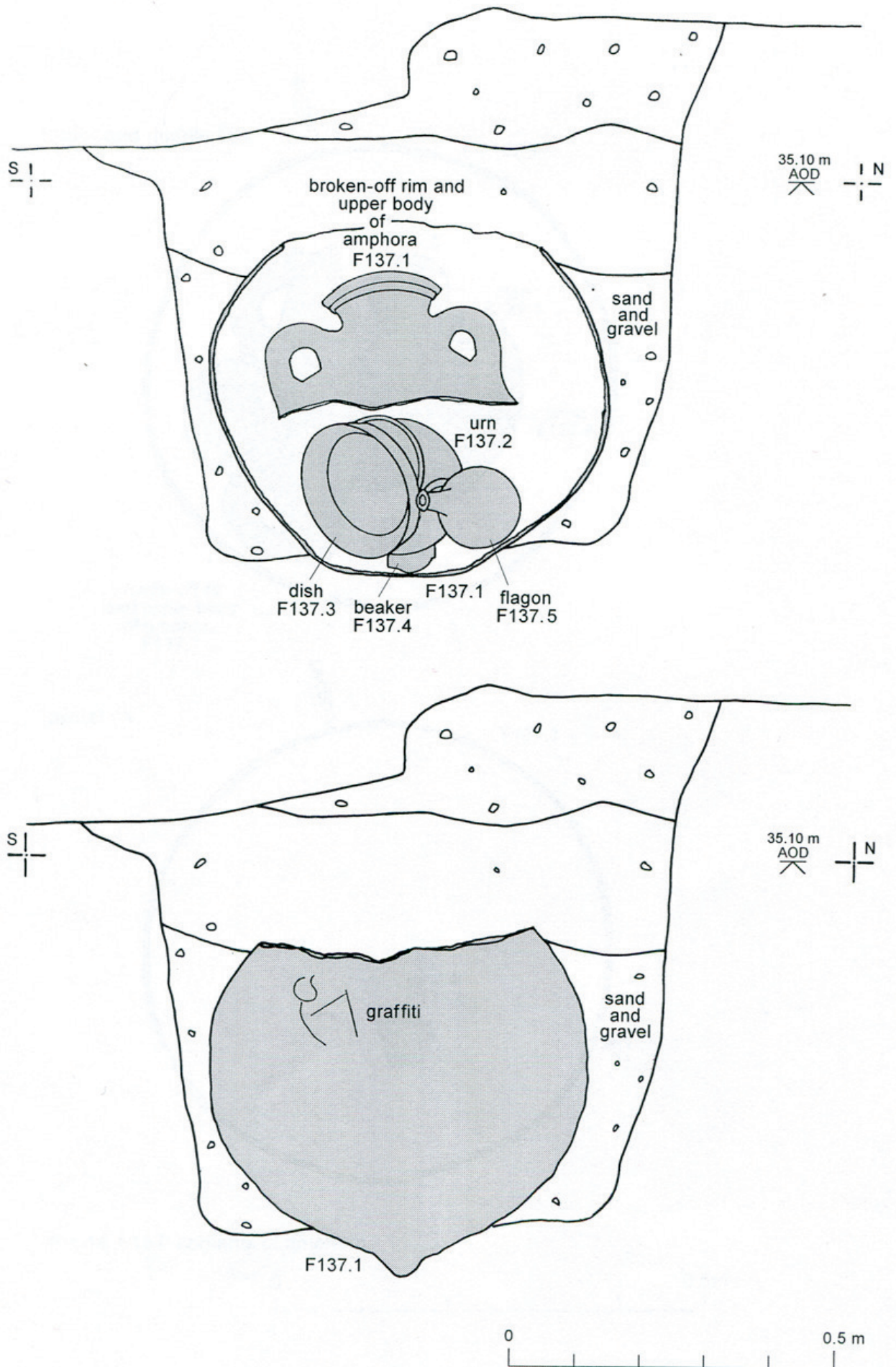


Fig 43 F137: sections.

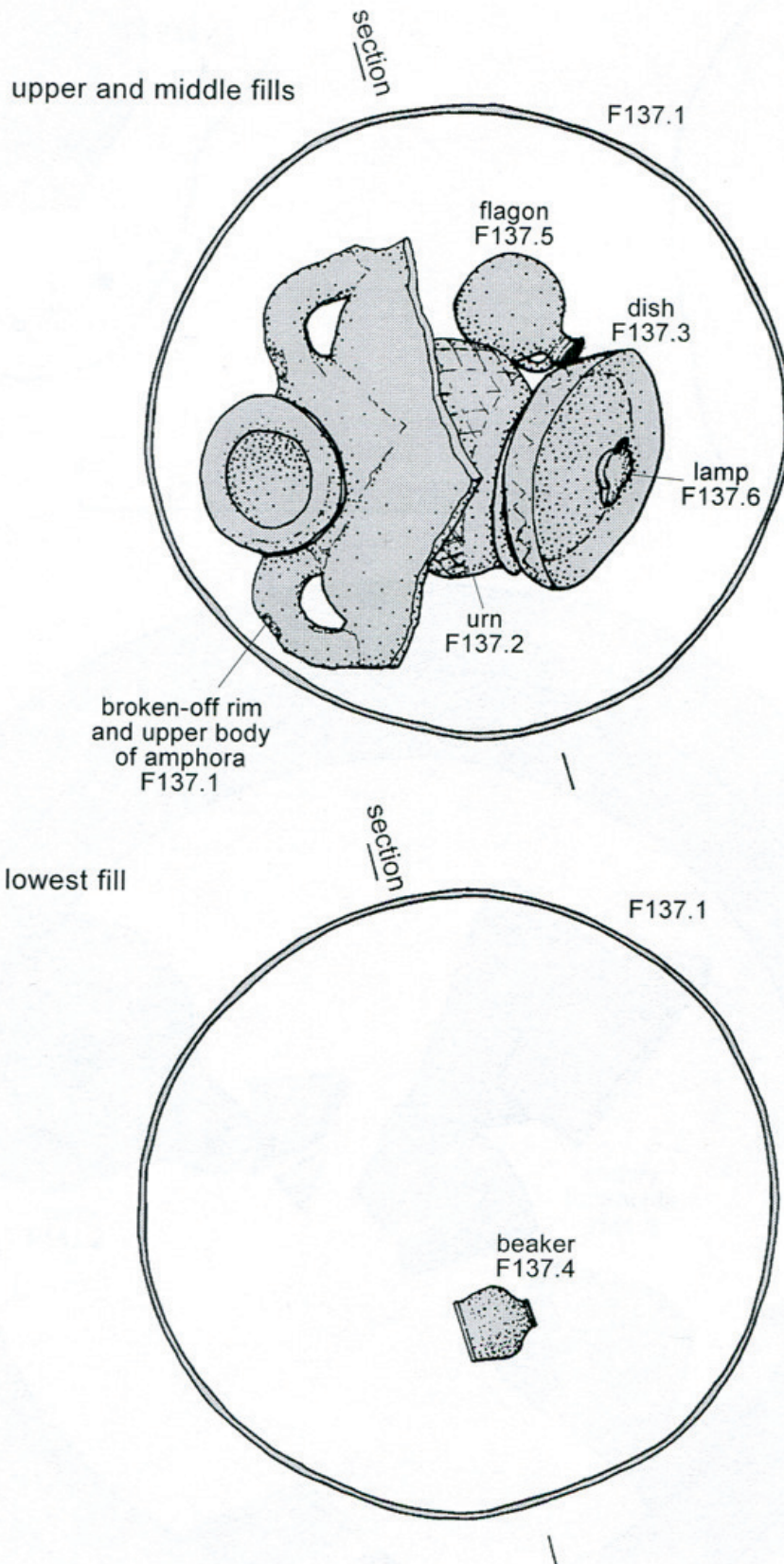


Fig 44 F137: contents of amphora.



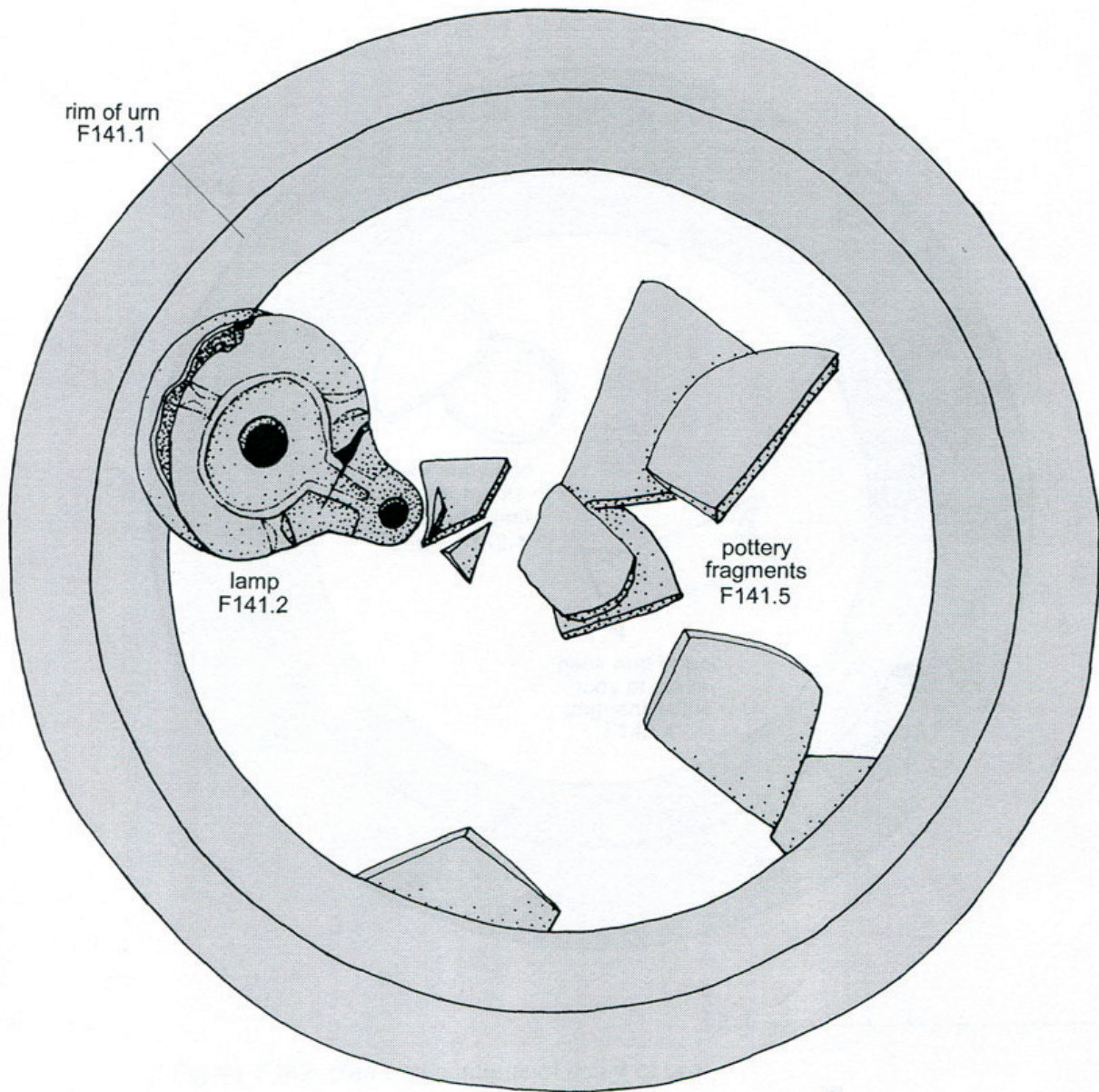
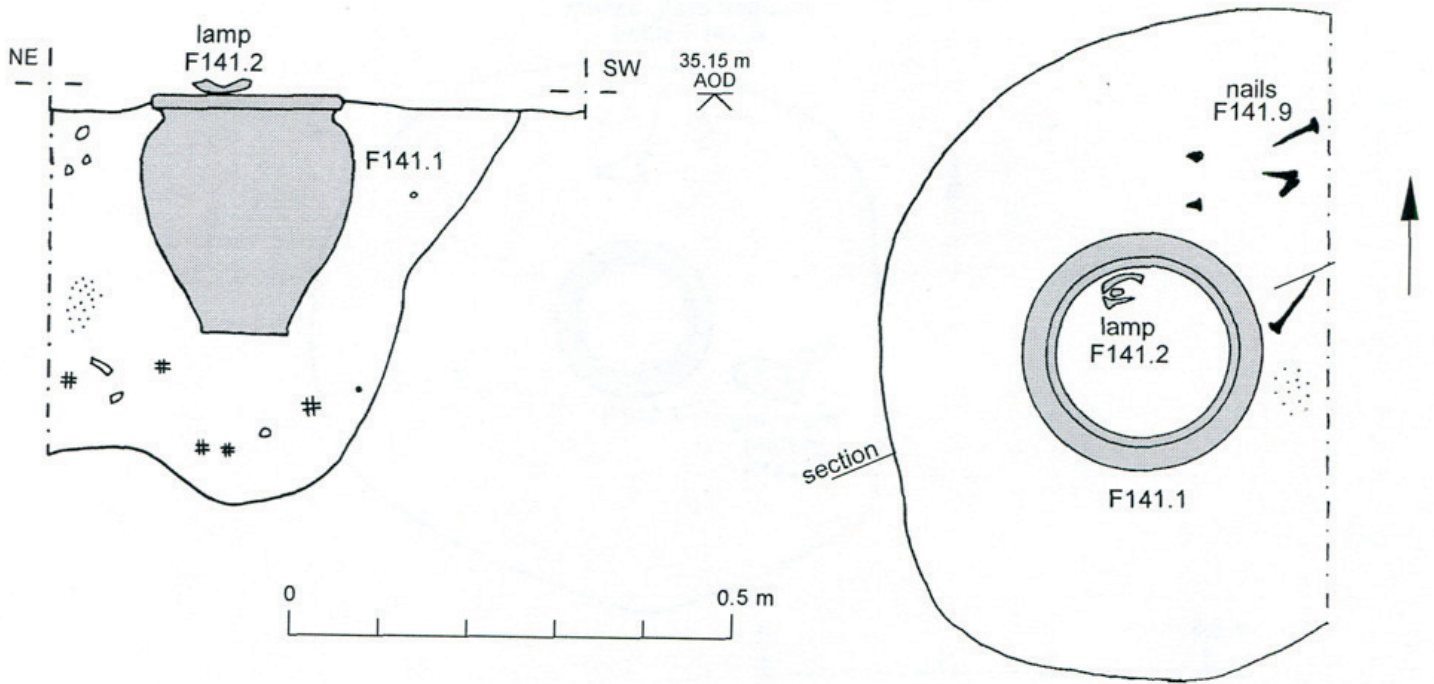


Fig 45 F141: section, plan and contents of urn.



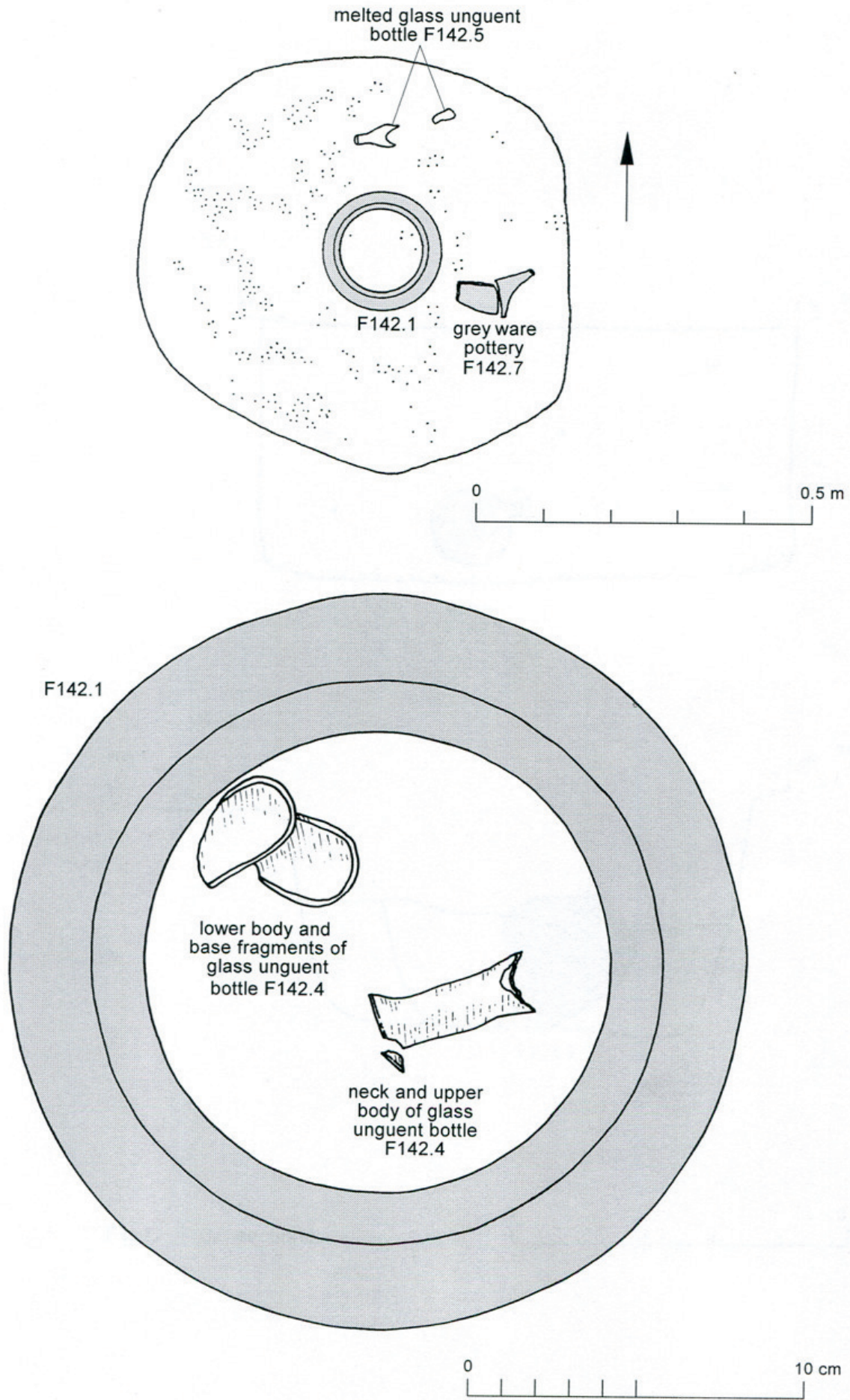
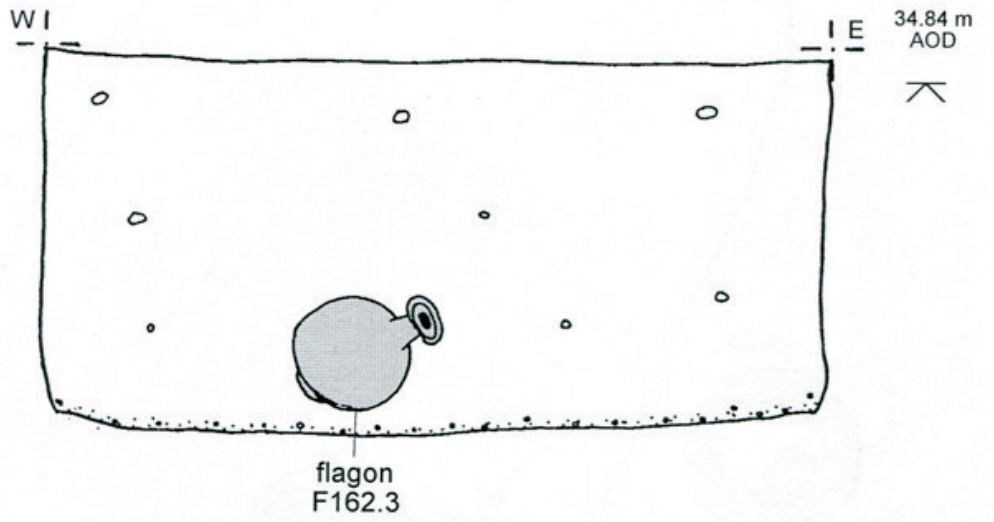


Fig 46 F142: plan and contents of spit 6 of urn.

Sx 1



Sx 2

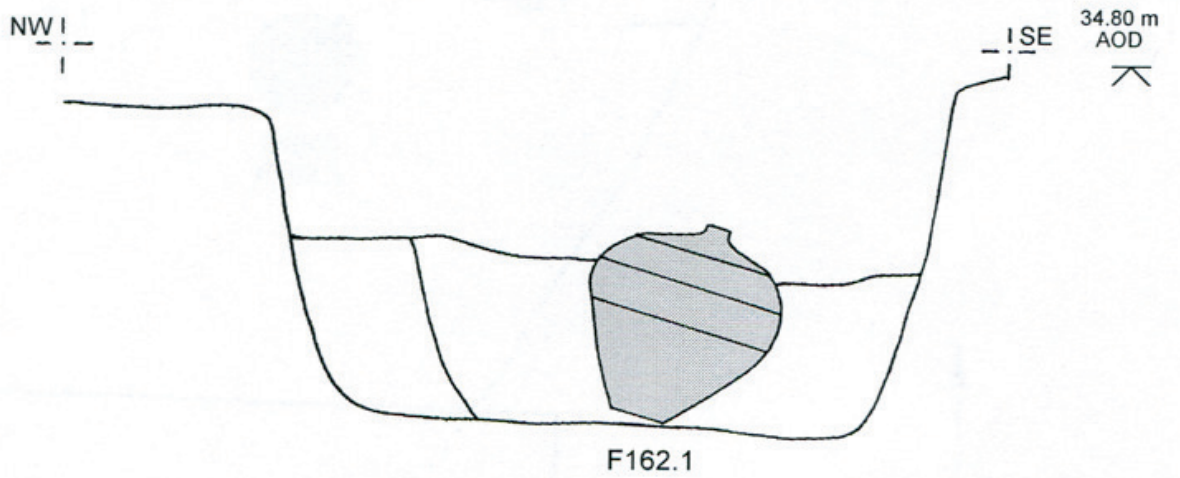
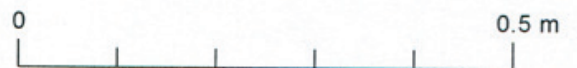


Fig 47 F162: sections.



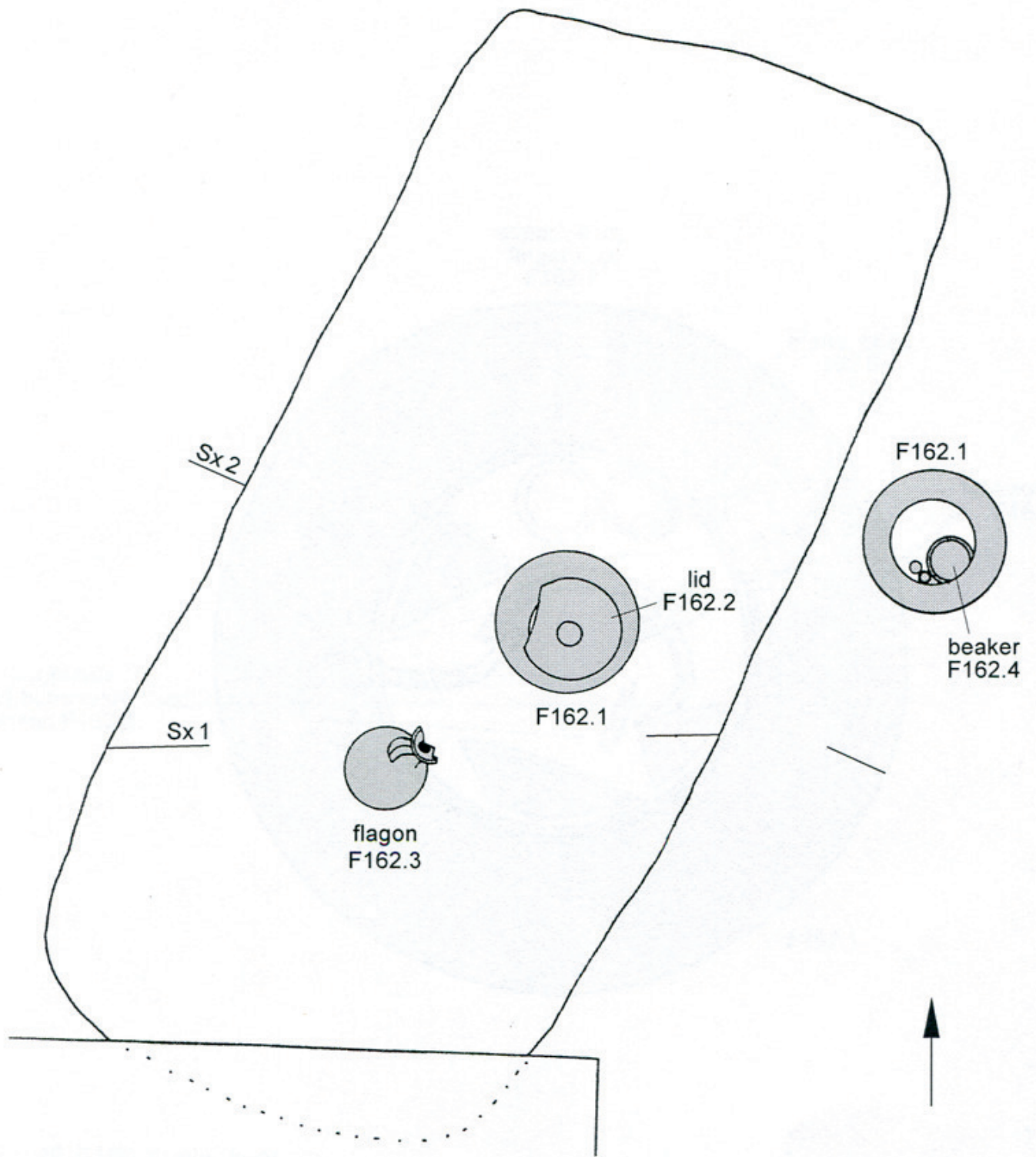
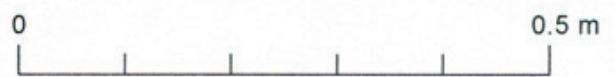


Fig 48 F162: plan.



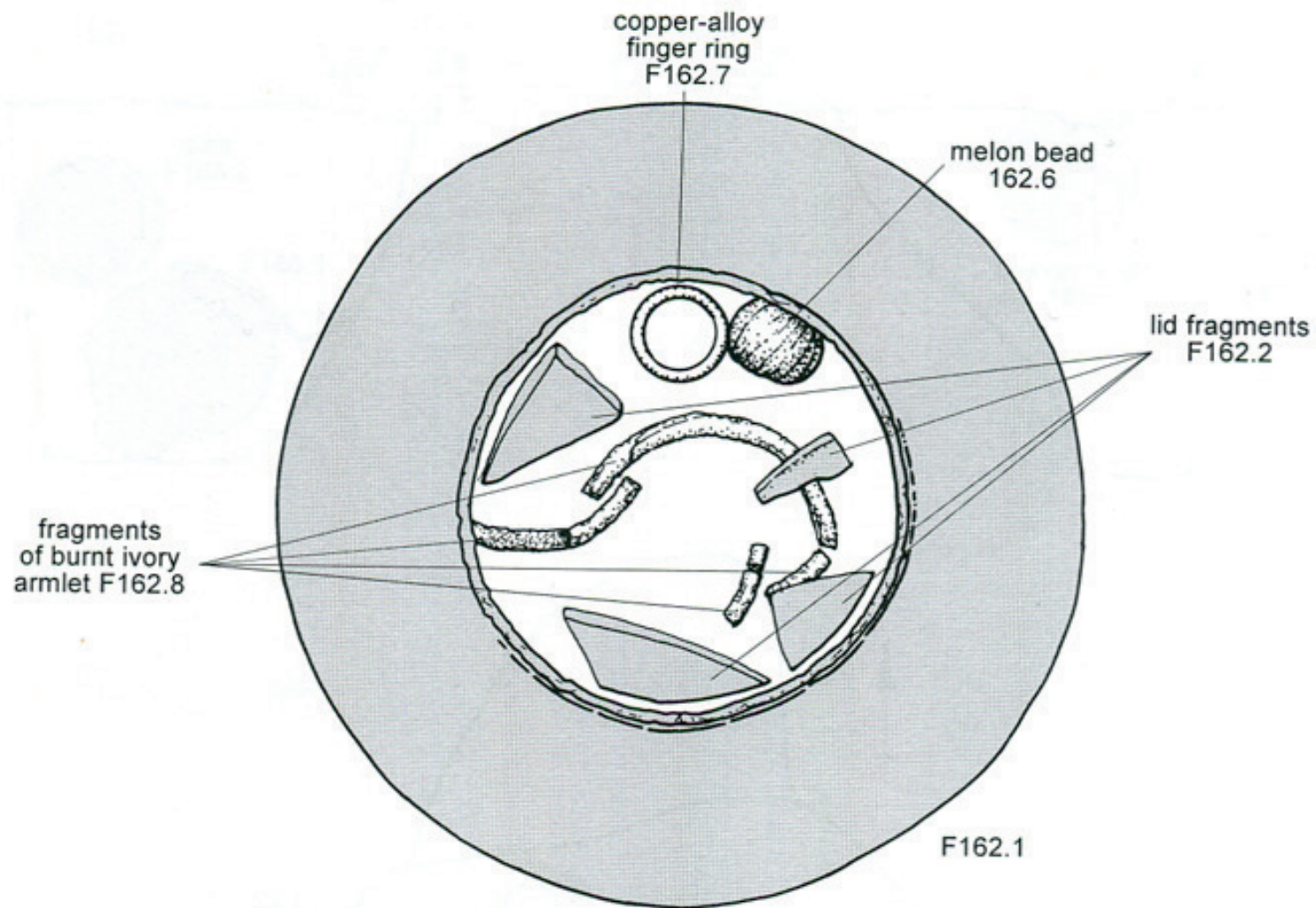


Fig 49 F162: contents of urn.

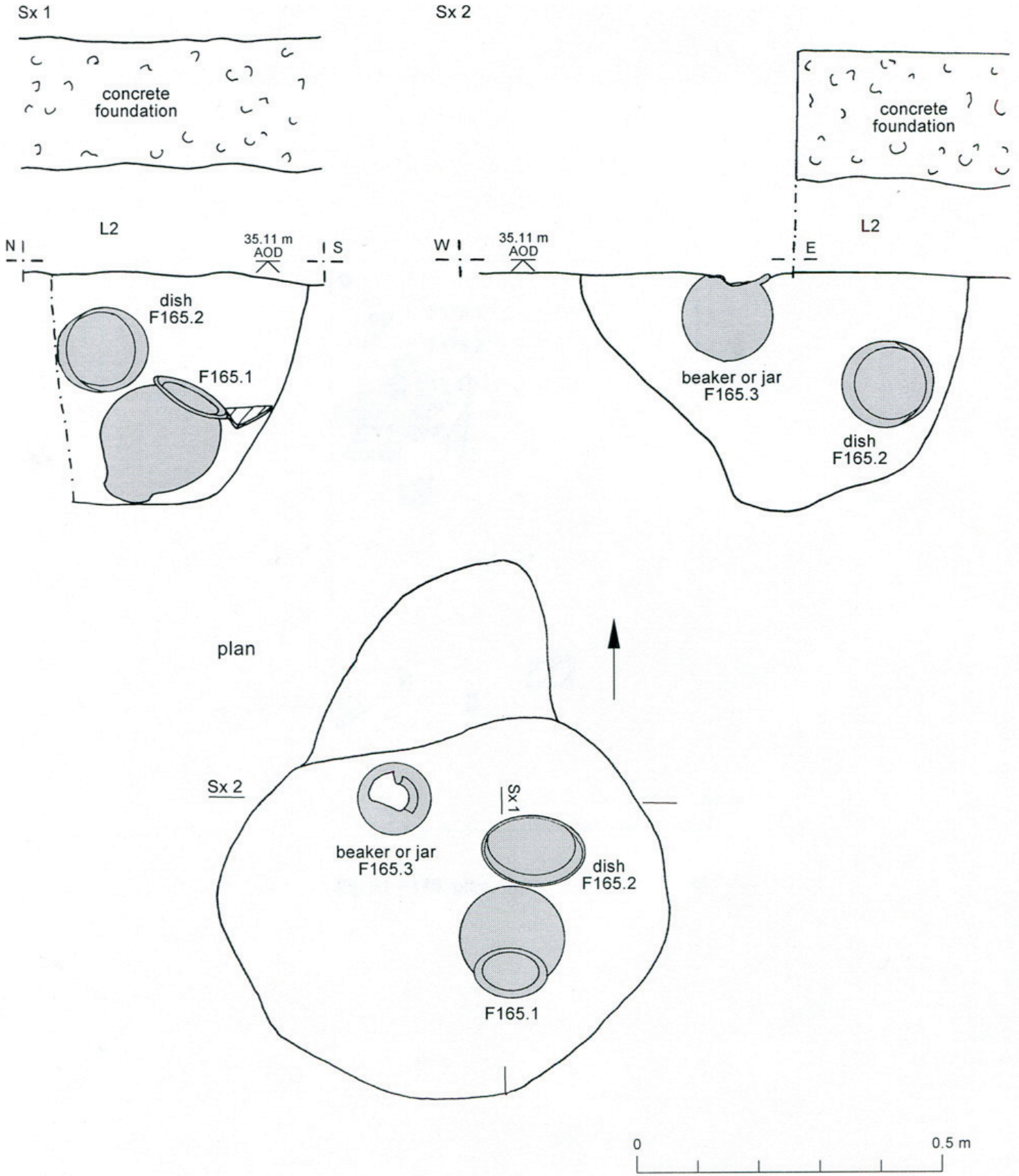


Fig 50 F165: sections and plan.

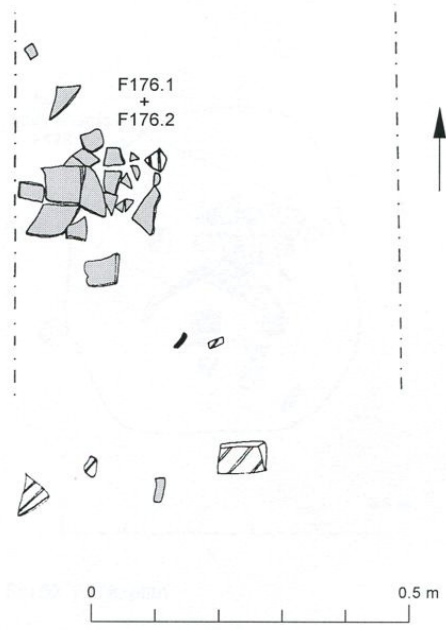


Fig 51 F176: plan.

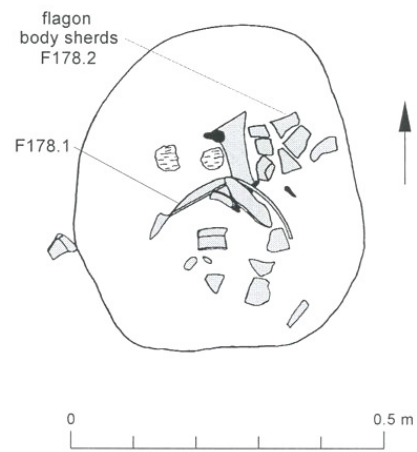


Fig 52 F178: plan.

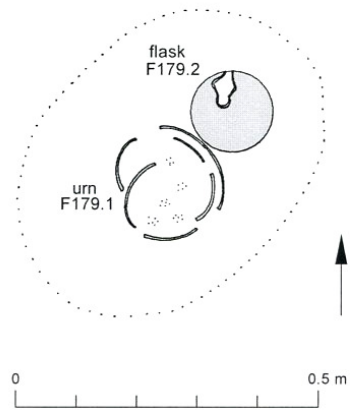


Fig 53 F179: plan.

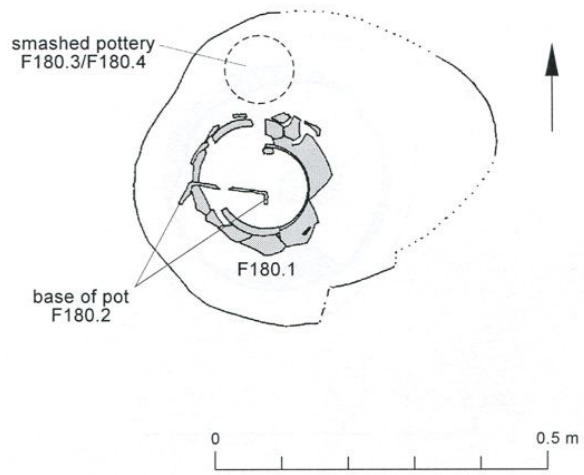


Fig 54 F180: plan.

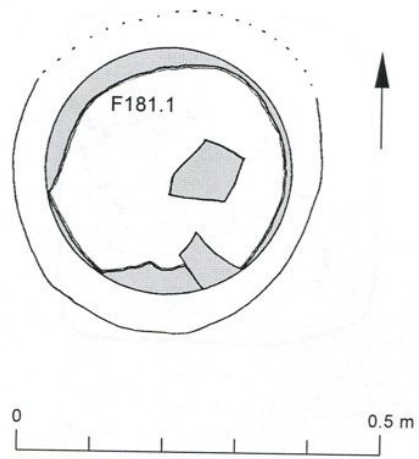


Fig 55 F181: plan.

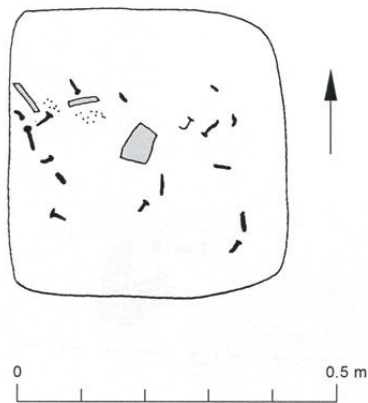


Fig 56 F182: plan.

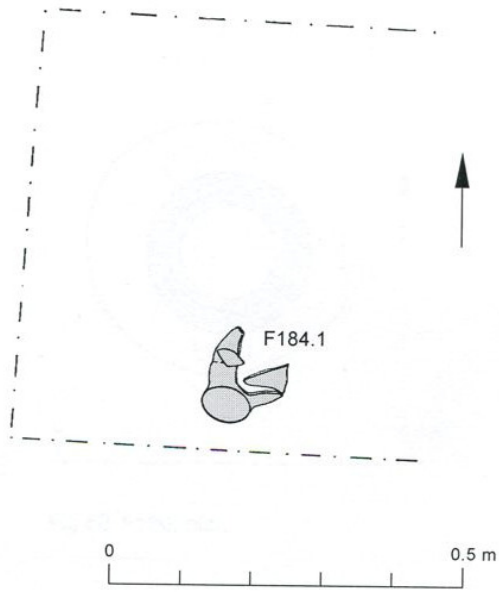


Fig 57 F184: plan.

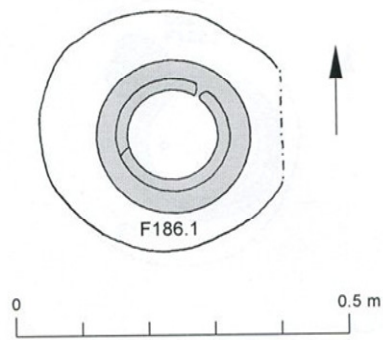


Fig 58 F186: plan.

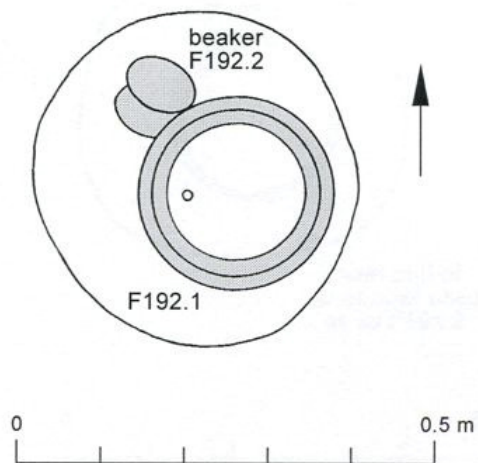


Fig 59 F192: plan.

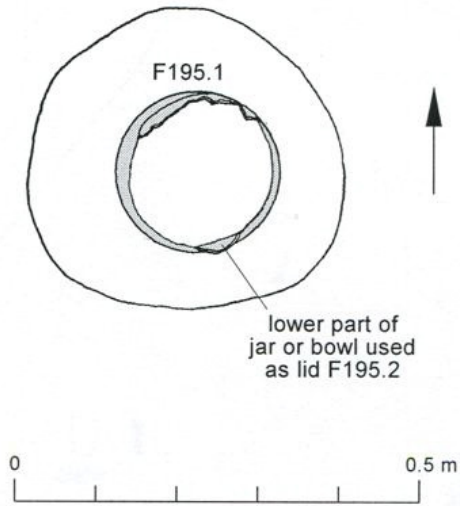


Fig 60 F195: plan.

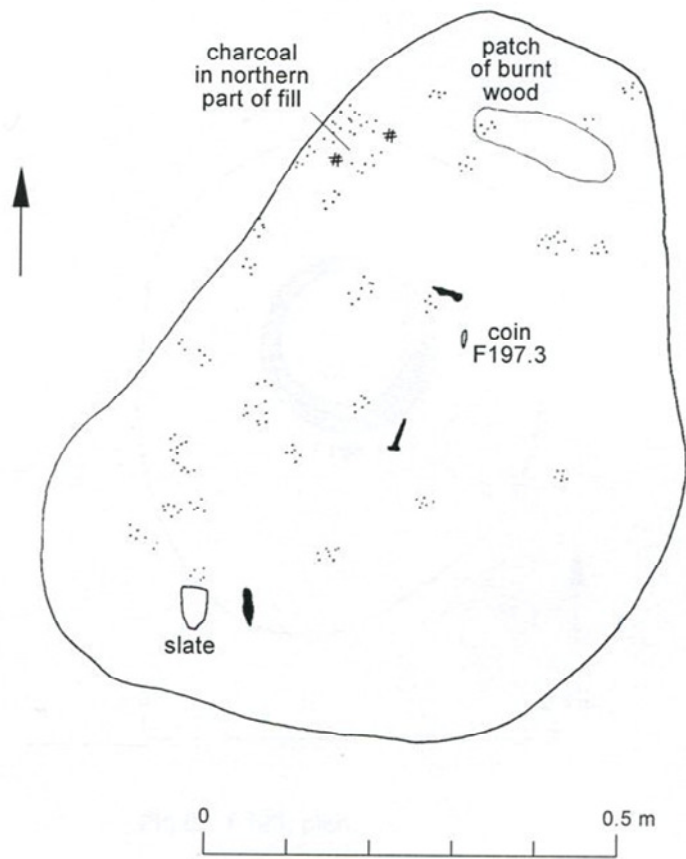


Fig 61 F197: plan.

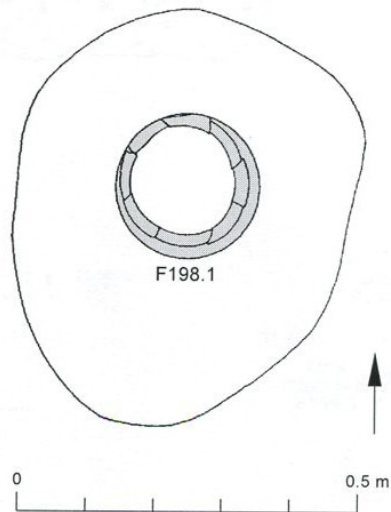


Fig 62 F198: plan.

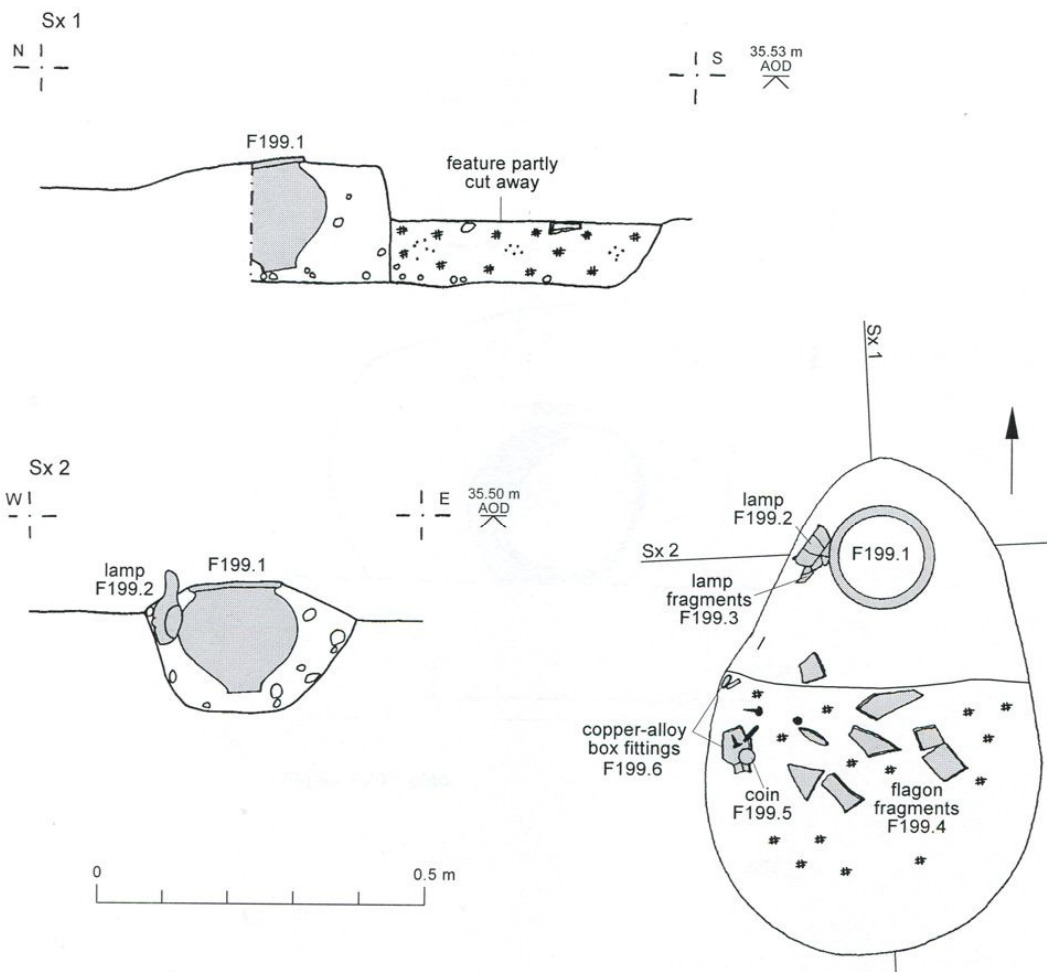


Fig 63 F199: sections and plan.

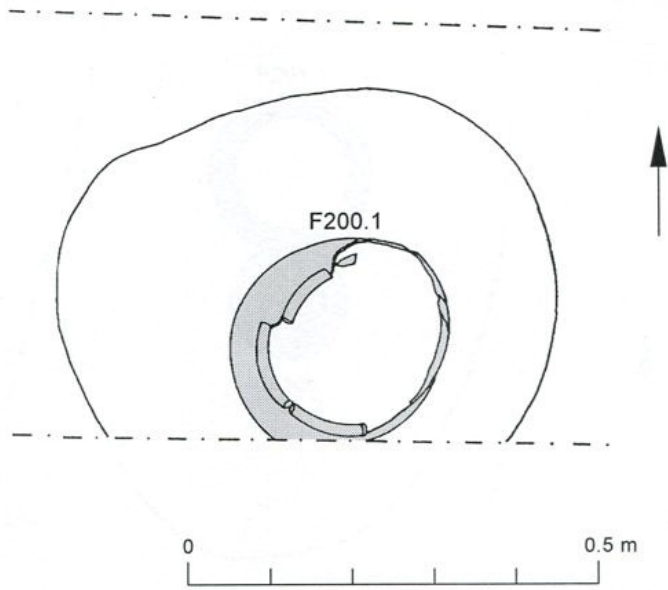


Fig 64 F200: plan.

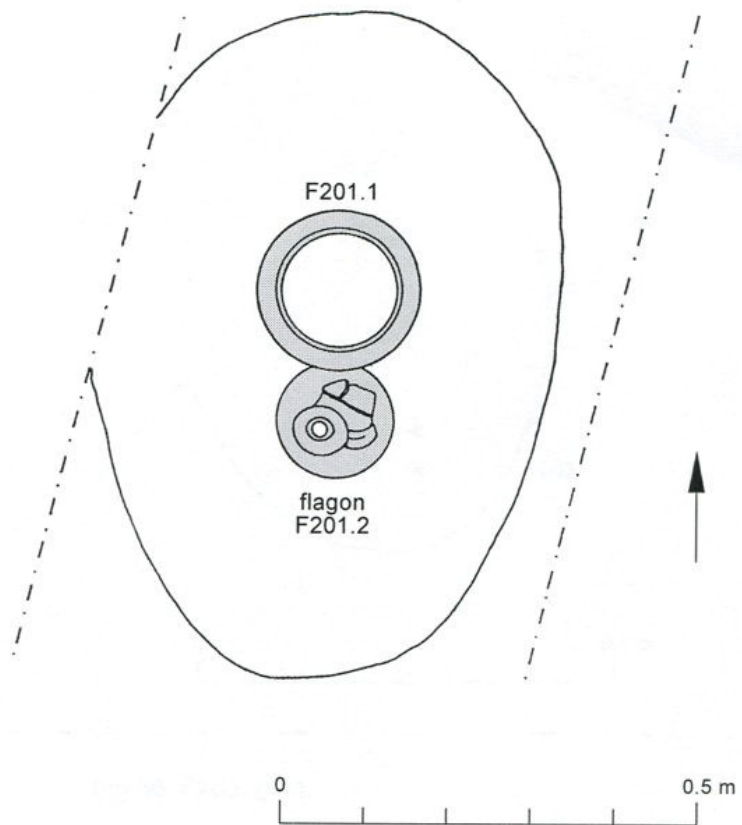


Fig 65 F201: plan.

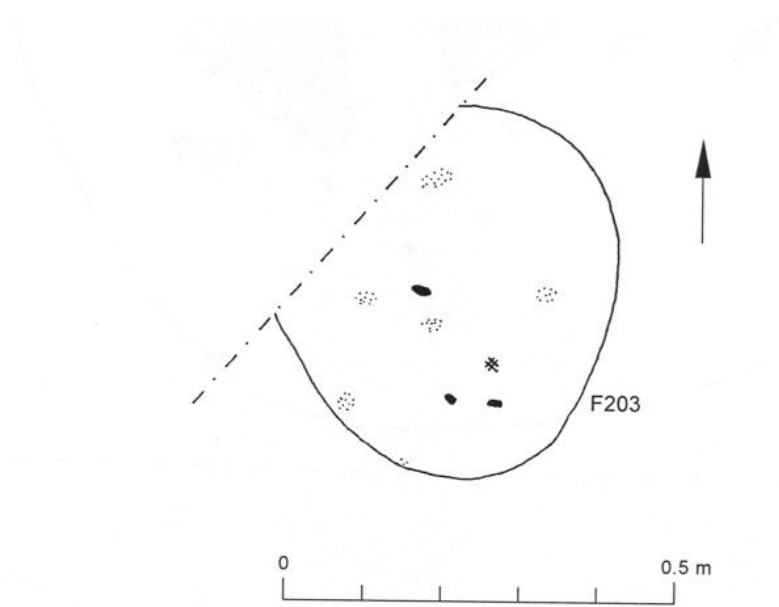


Fig 66 F203: plan.

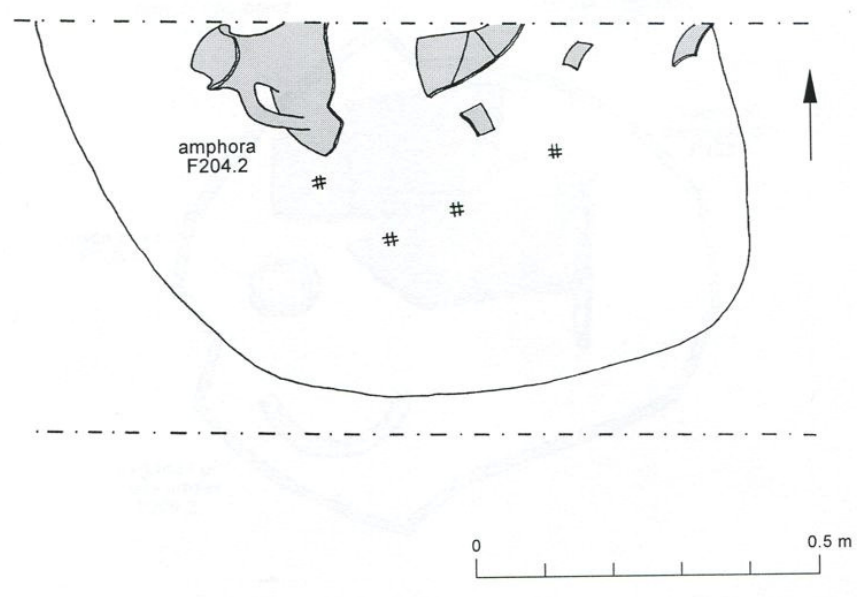


Fig 67 F204: plan.

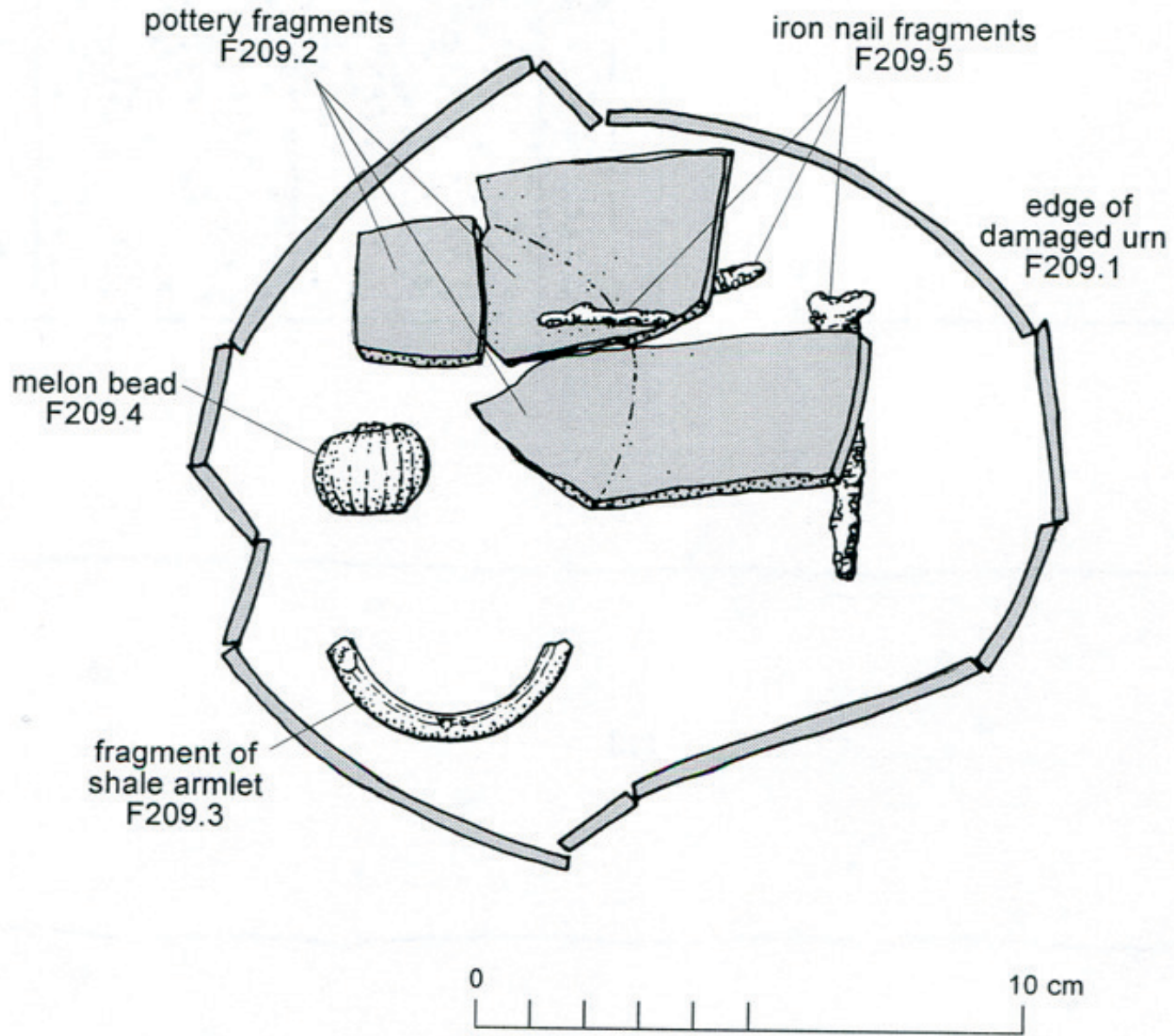


Fig 68 F209: contents of base of urn.

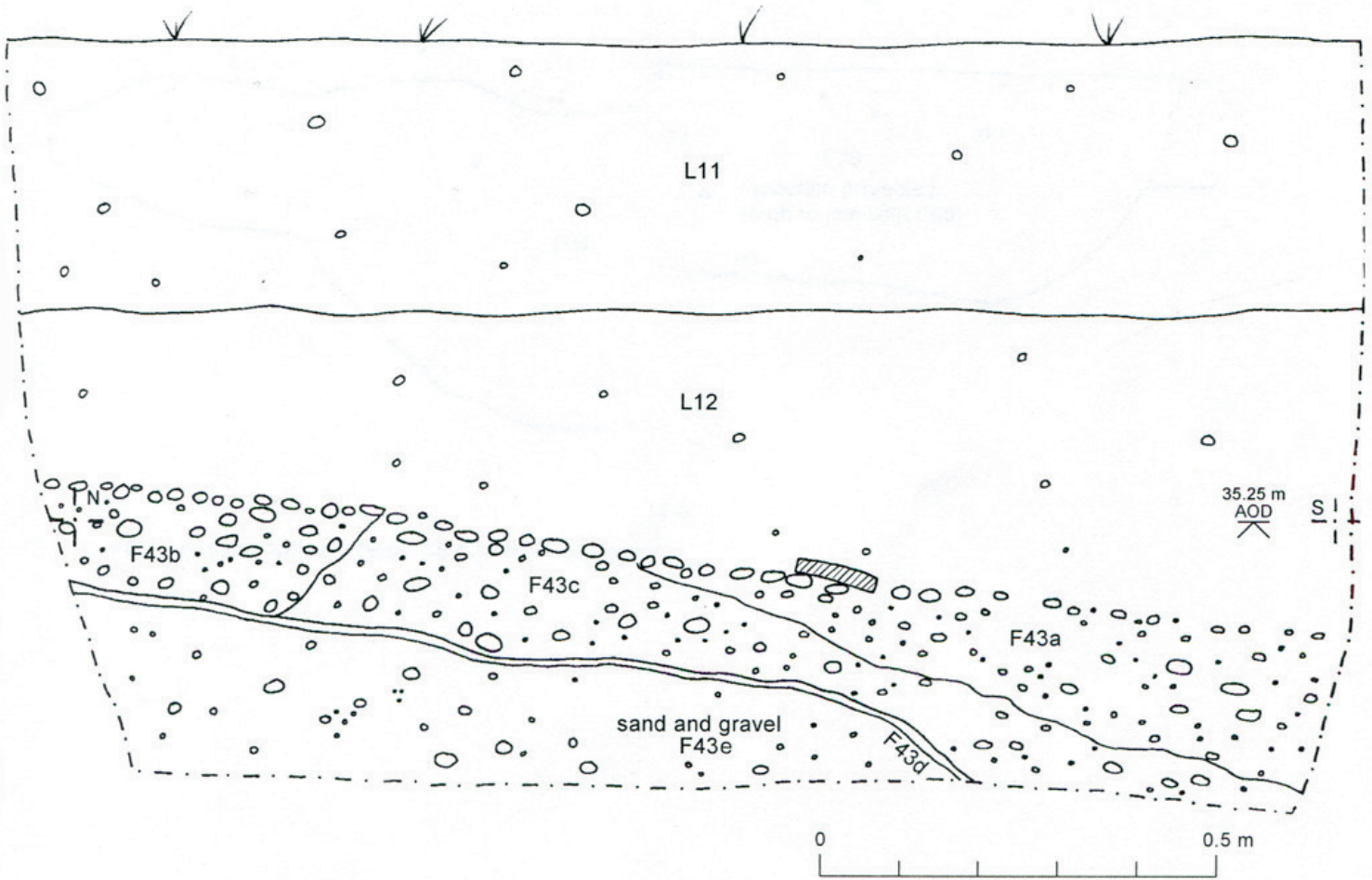
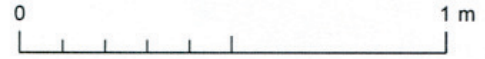
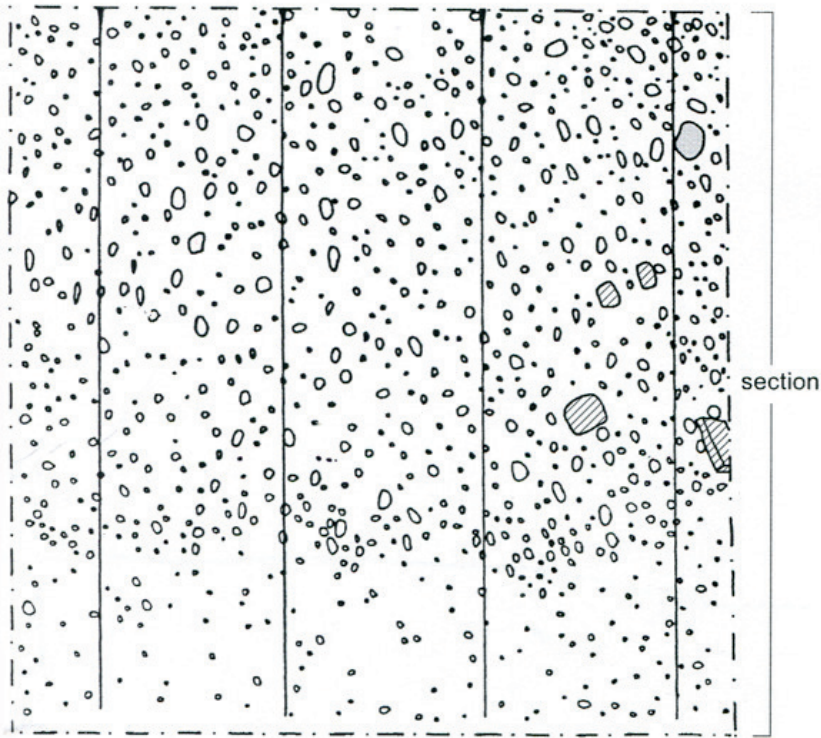


Fig 69 F43 metalling: plan and section.

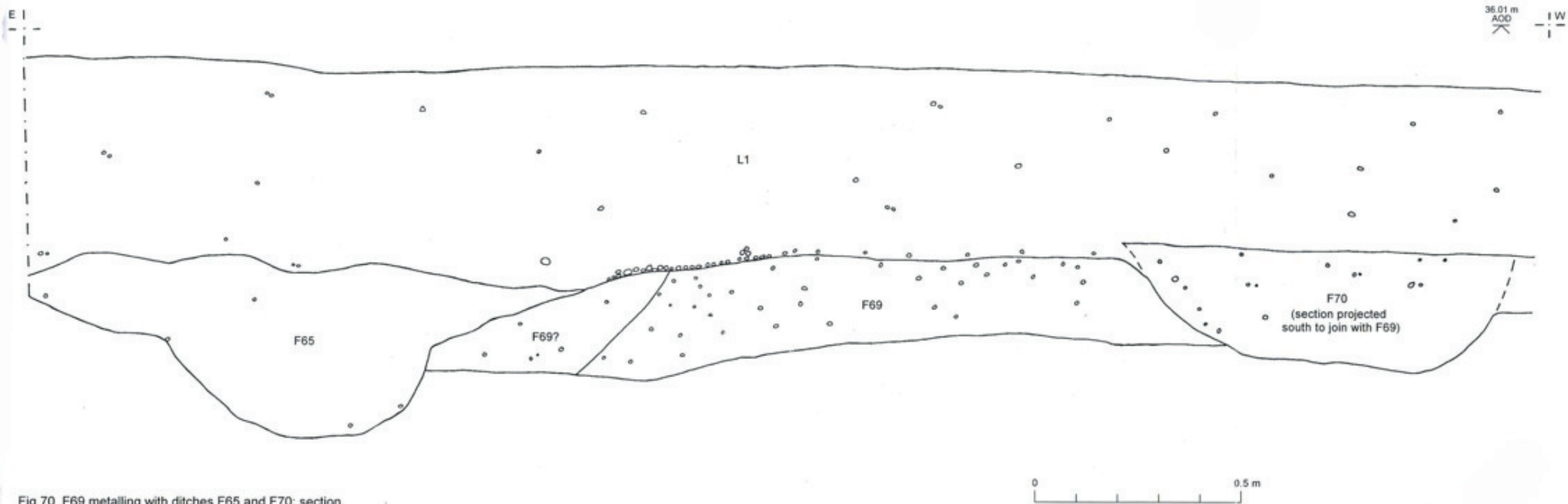


Fig 70 F69 metallurgy with ditches F65 and F70: section.

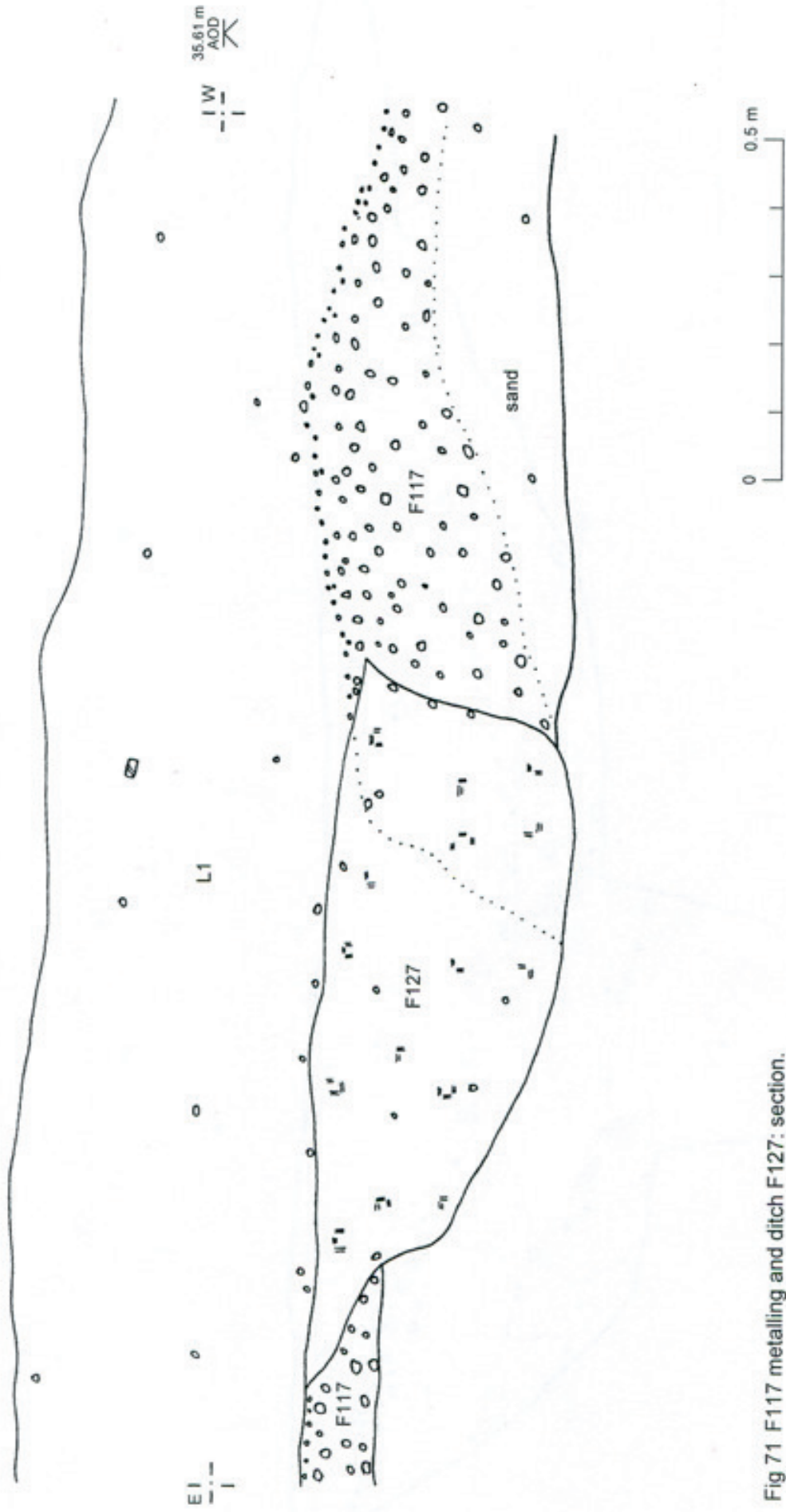


Fig 71 F117 metallurgy and ditch F127: section.

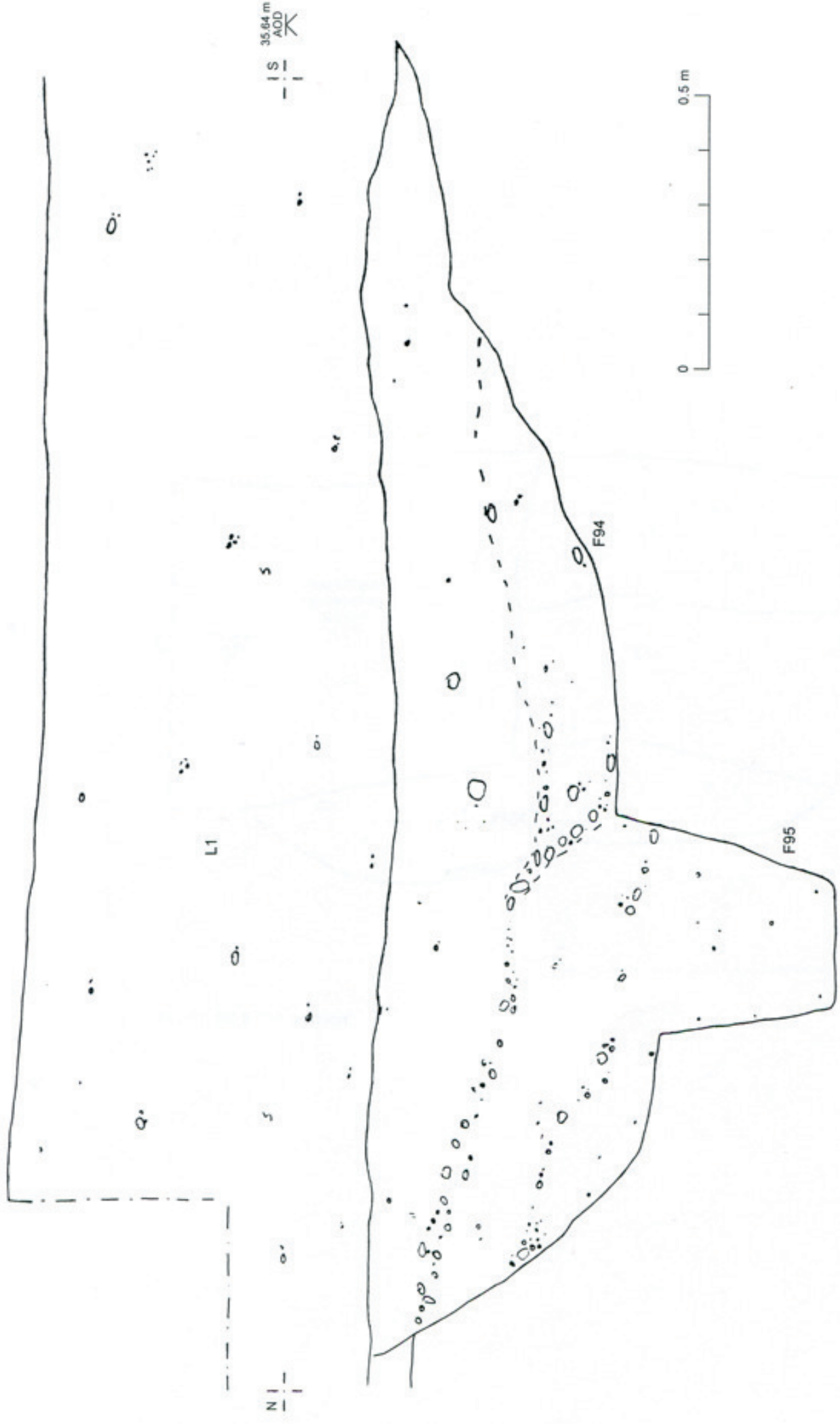


Fig 72 Ditch F94 with gully F95: section.

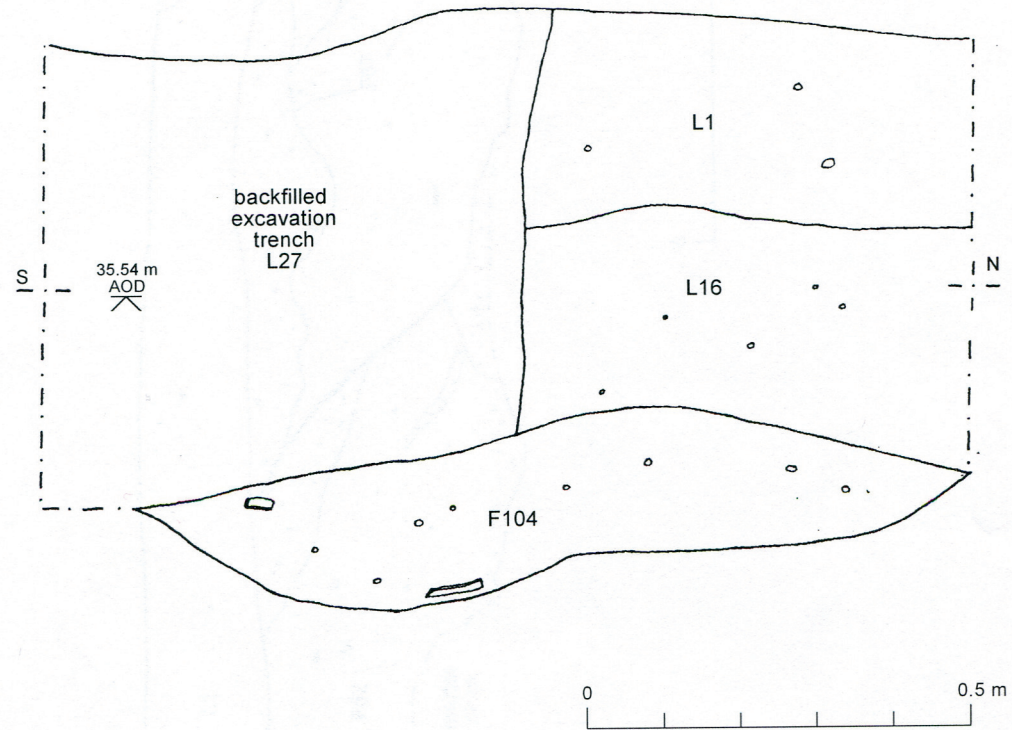


Fig 73 Pit F104: section.

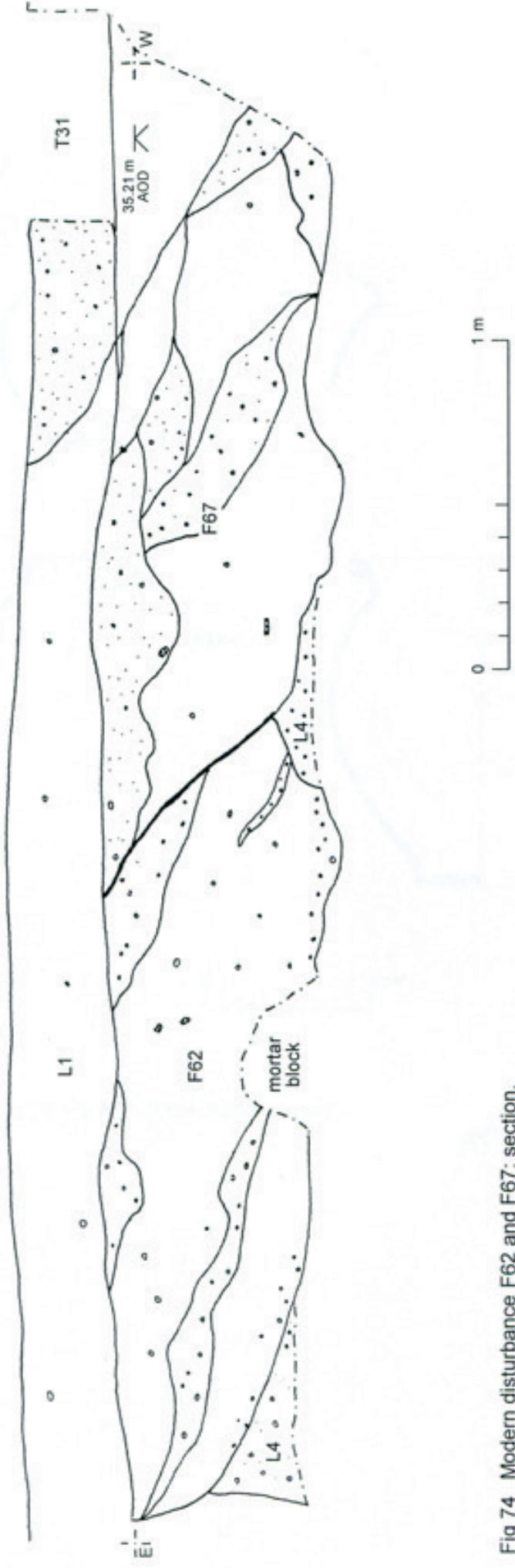


Fig 74 Modern disturbance F62 and F67: section.

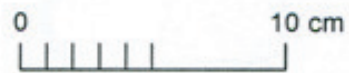
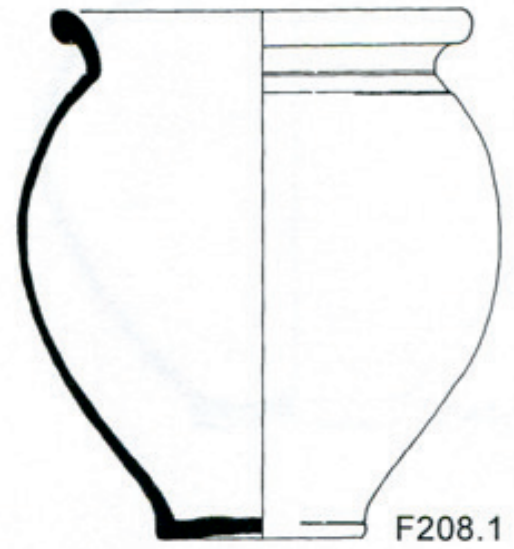
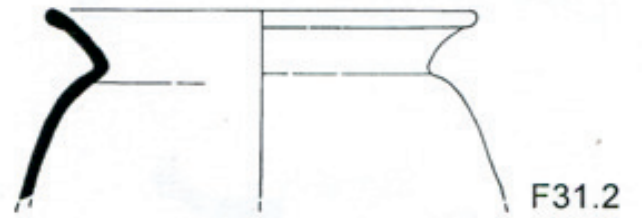
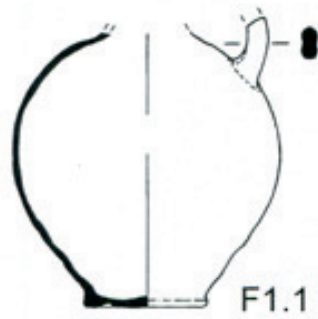


Fig 75 F1, F31, F154, F208: pottery.

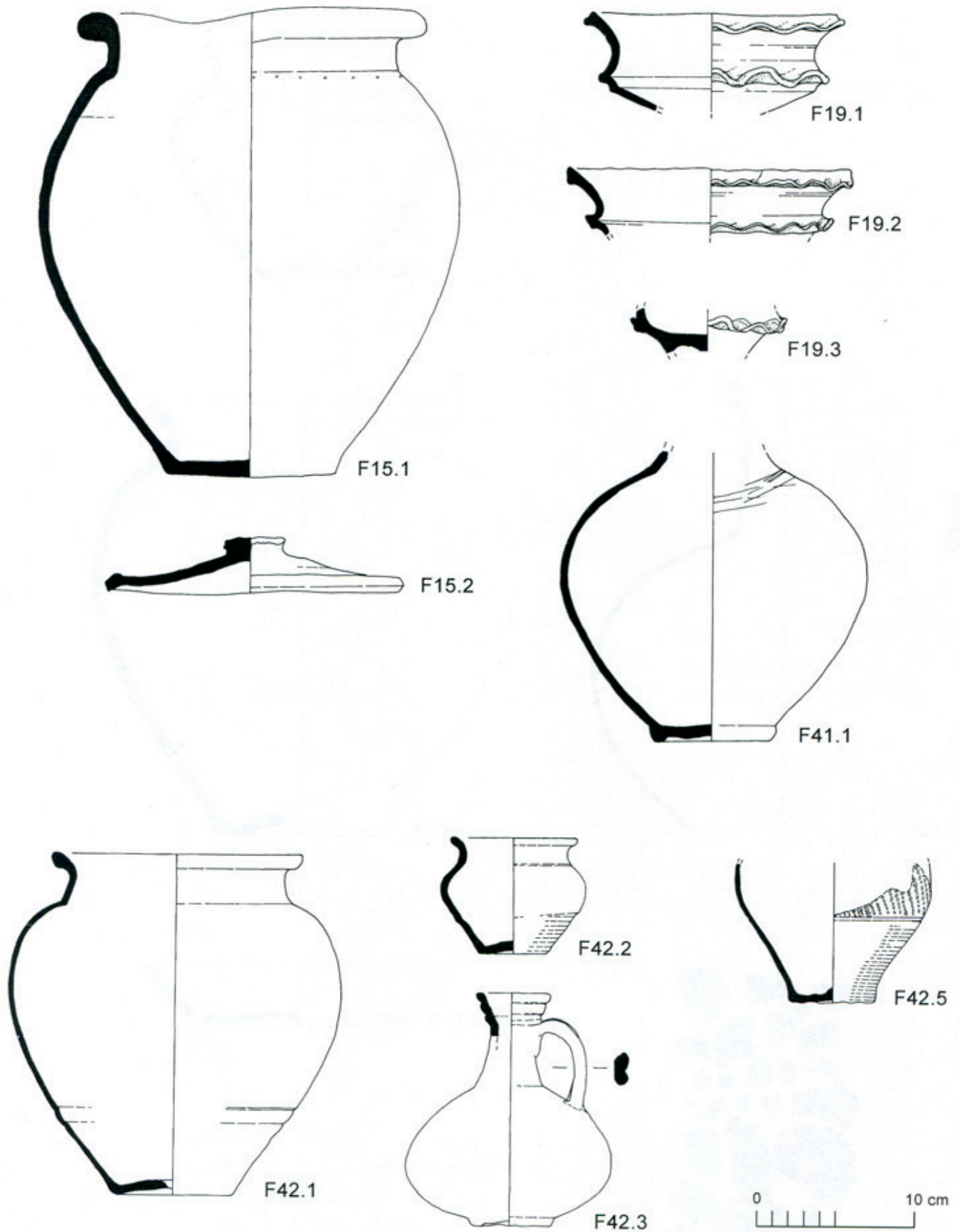
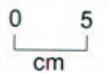
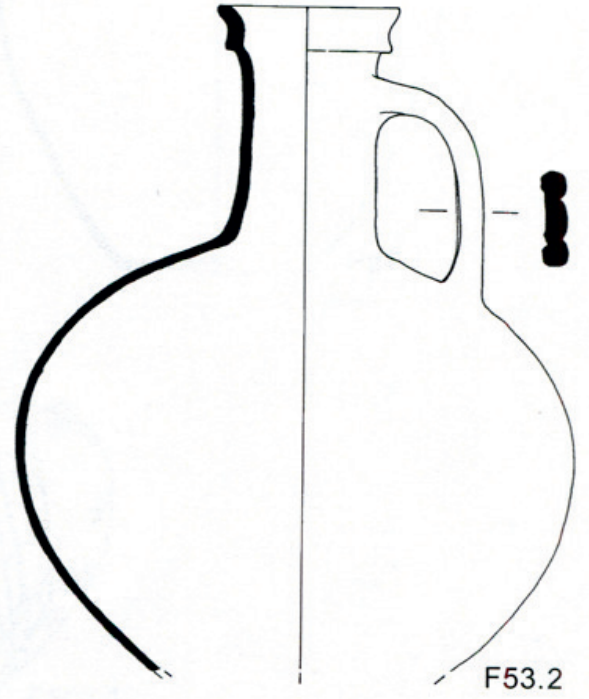
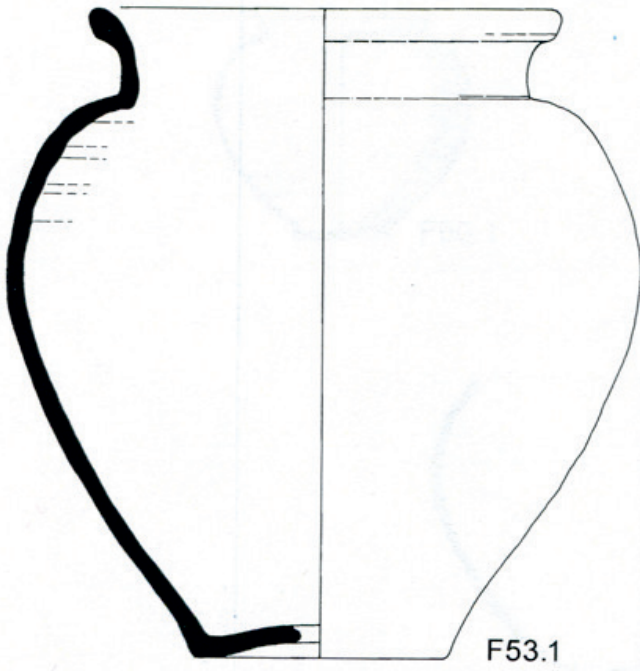
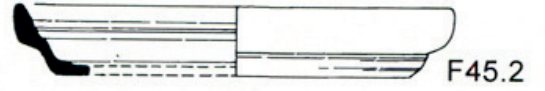
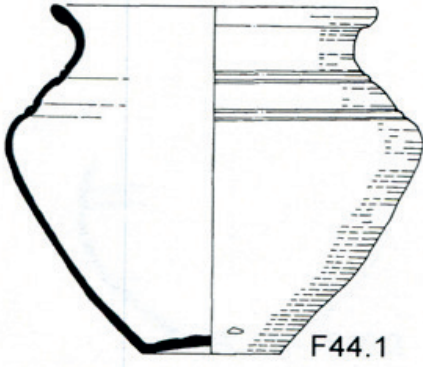
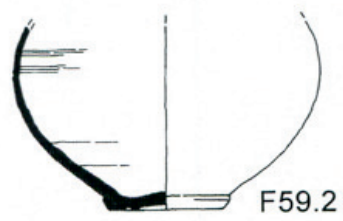


Fig 76 F15, F19, F41, F42: pottery.

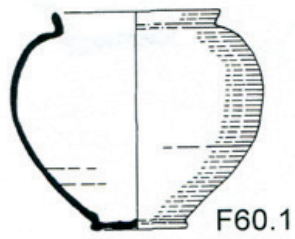


F53.4

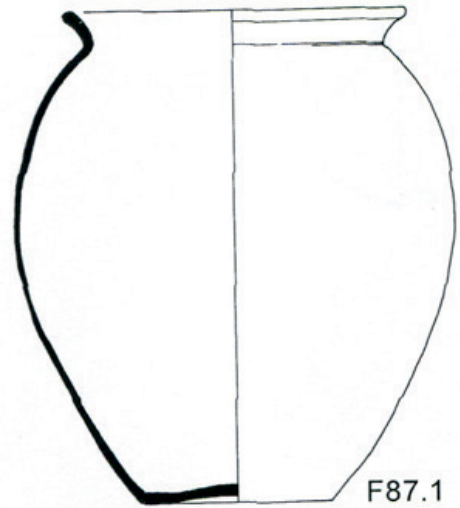
Fig 77 F44, F45, F53: pottery.



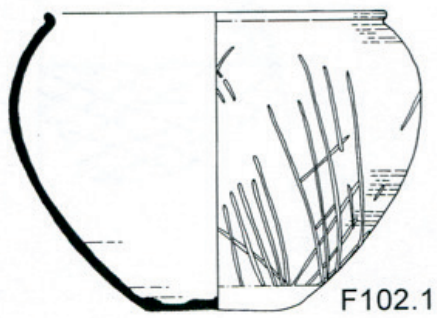
F59.2



F60.1



F87.1



F102.1

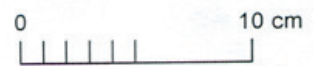


Fig 78 F59, F60, F87, F102: pottery.

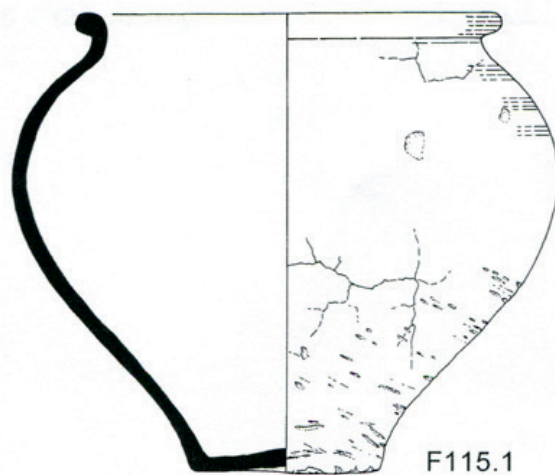
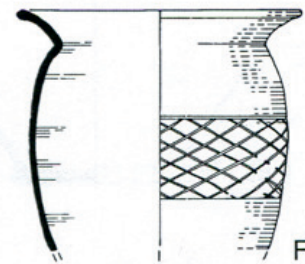
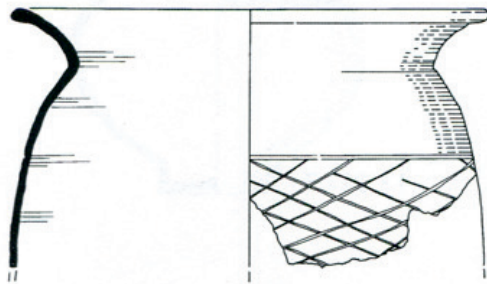
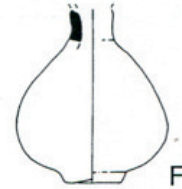
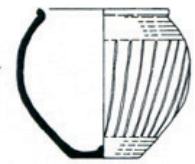
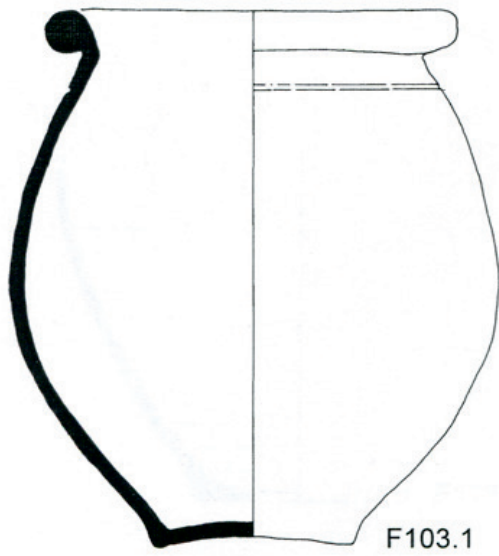


Fig 79 F103, F108, F113, F115: pottery.

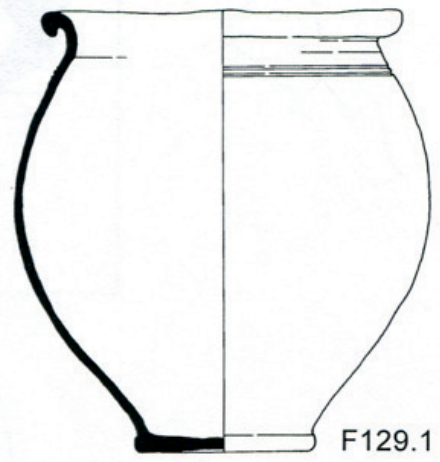
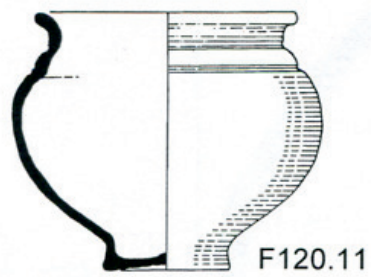
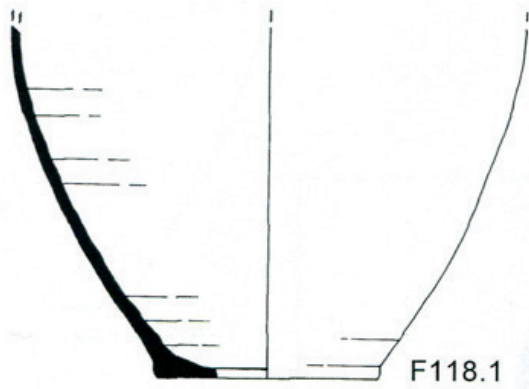
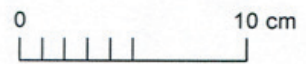


Fig 80 F118, F120, F128, F129: pottery.



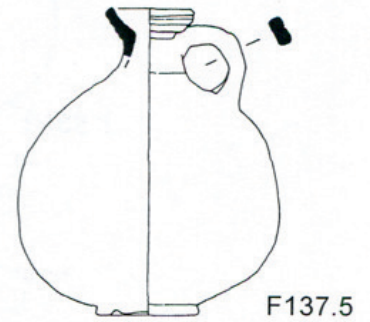
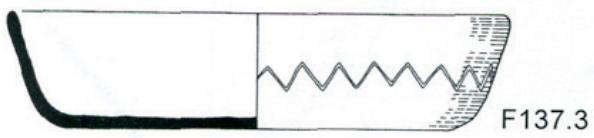
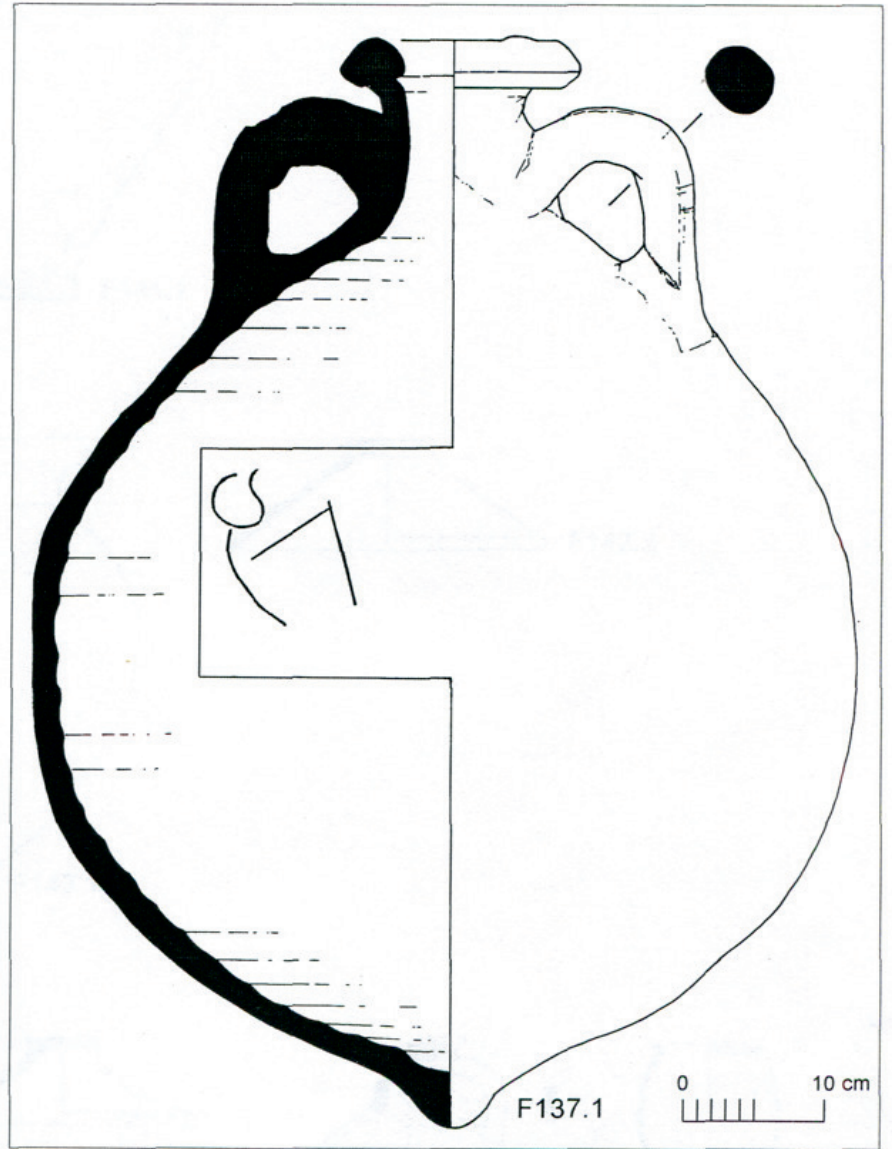
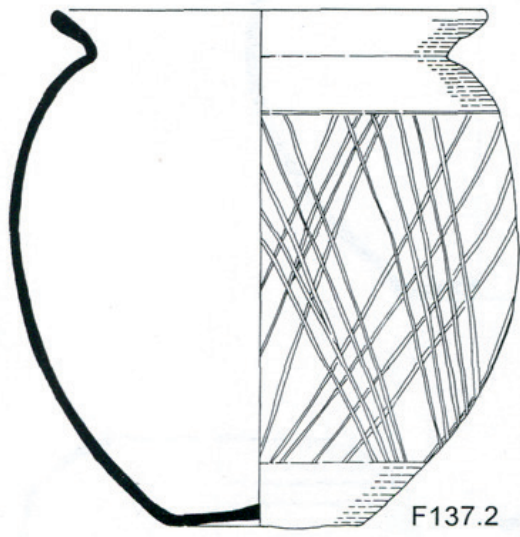
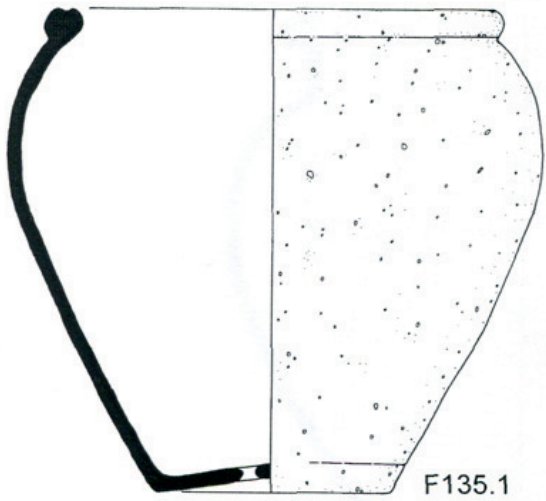


Fig 81 F135, F137: pottery.

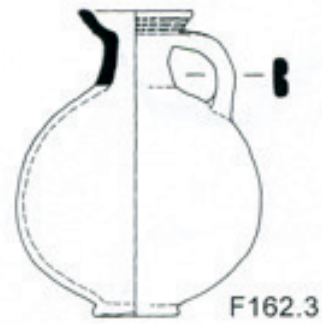
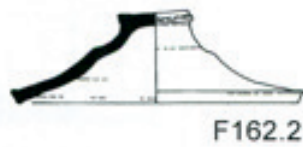
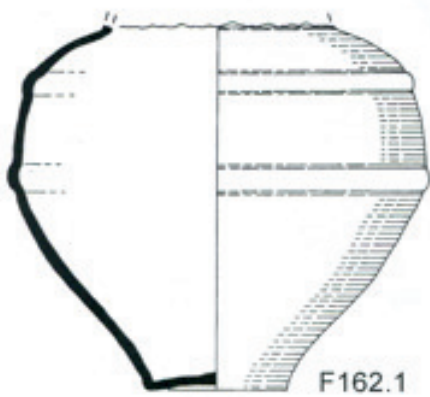
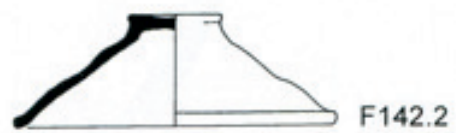
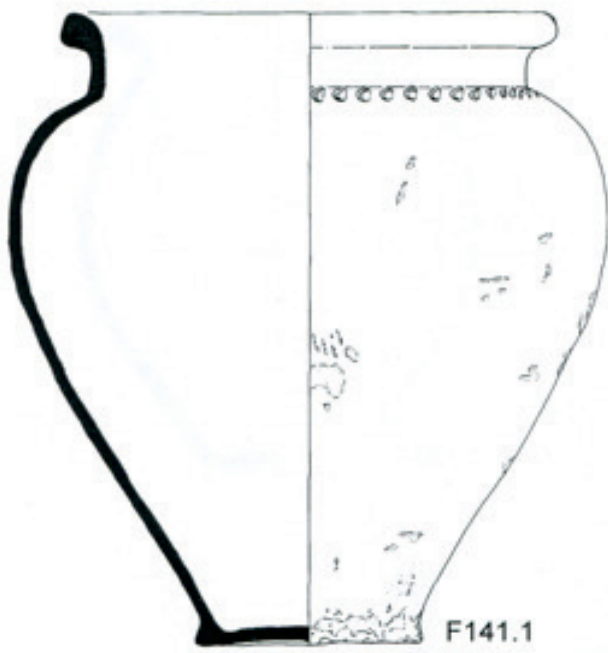
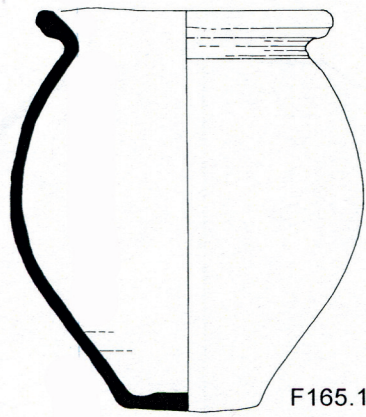
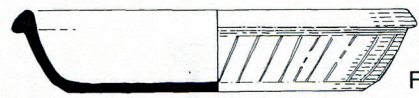


Fig 82 F141, F142, F162: pottery.

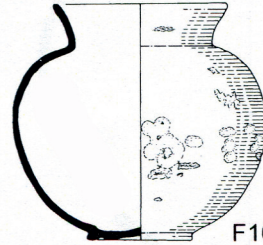




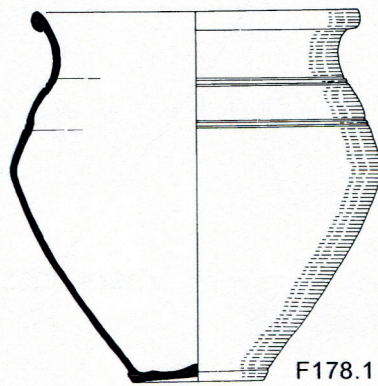
F165.1



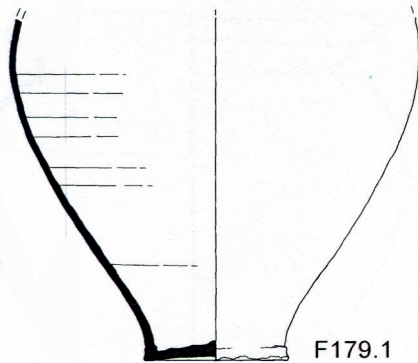
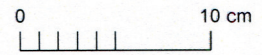
F165.2



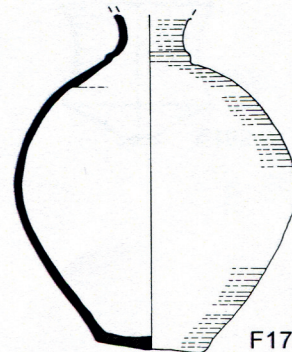
F165.3



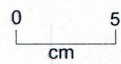
F178.1



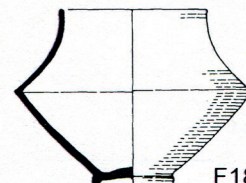
F179.1



F179.2



F180.2



F180.3

Fig 83 F165, F178, F179, F180: pottery.

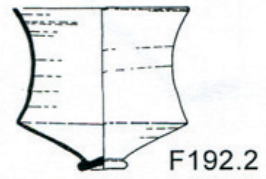
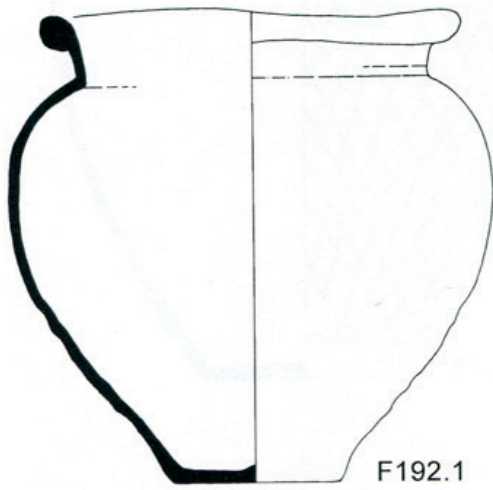
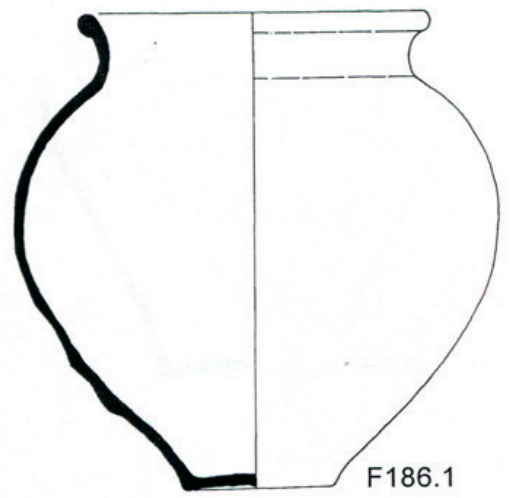
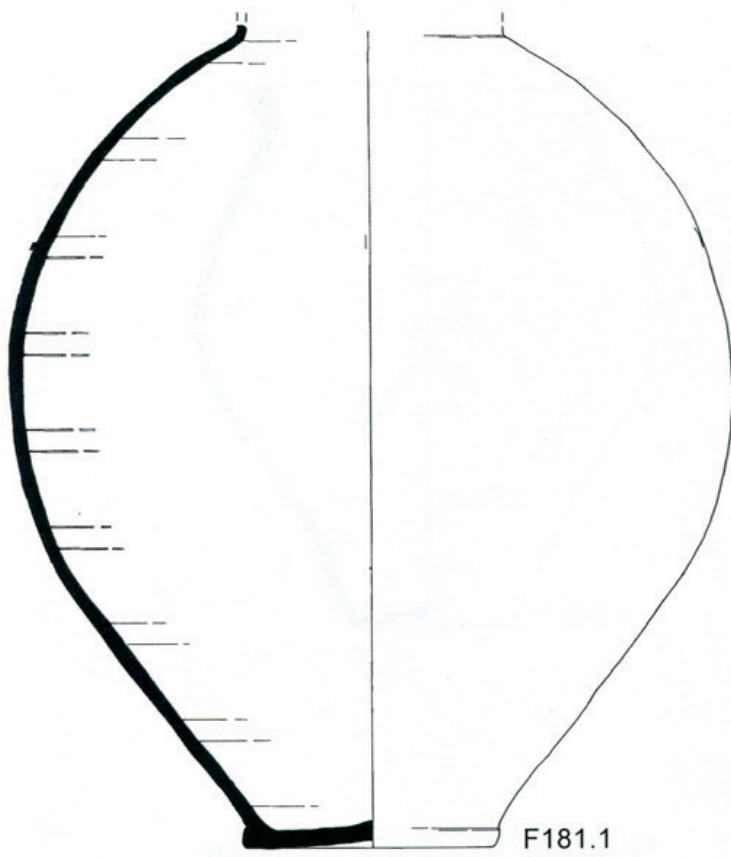


Fig 84 F181, F186, F192: pottery.

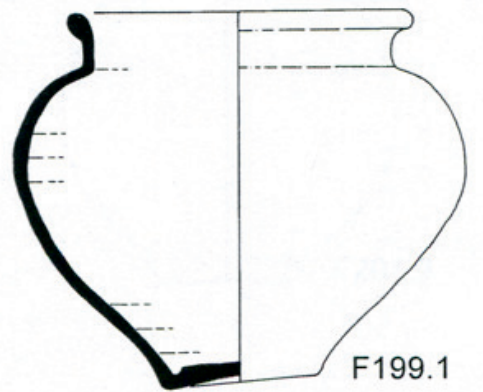
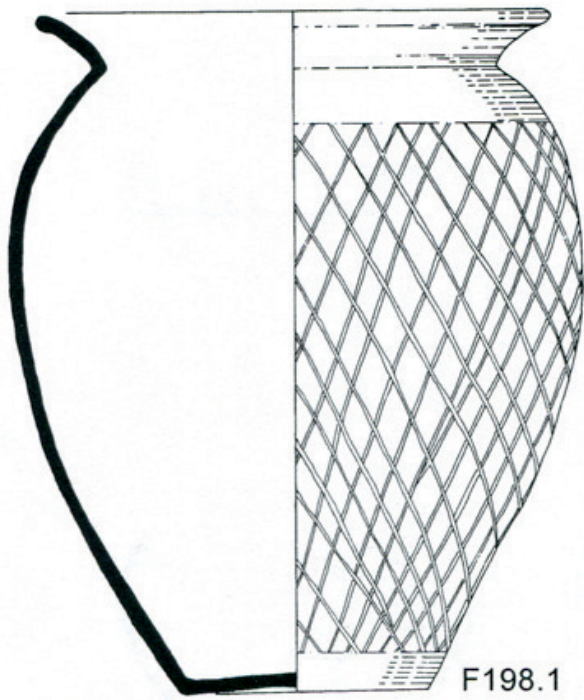
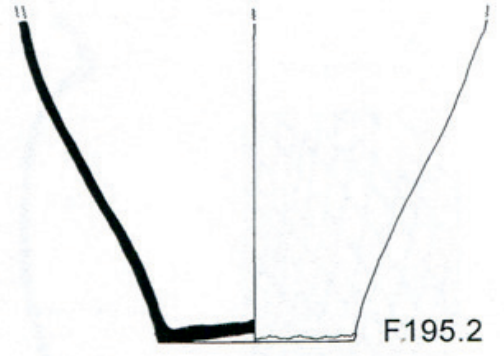
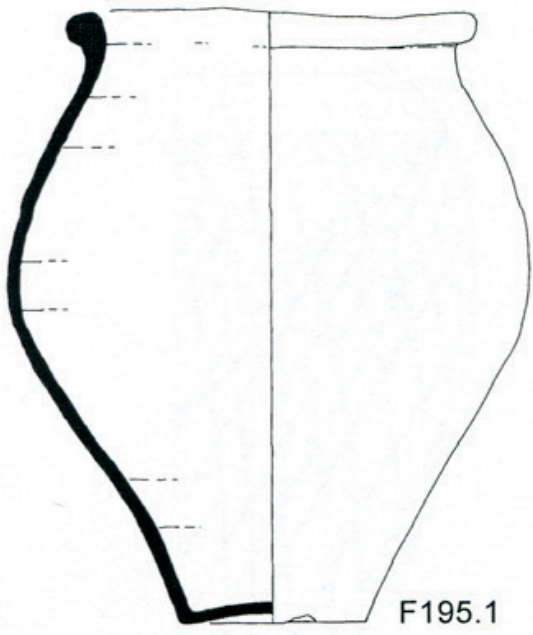


Fig 85 F195, F198, F199: pottery.

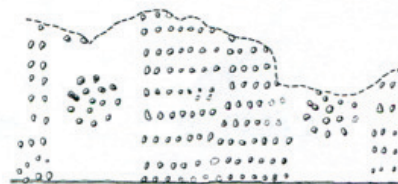
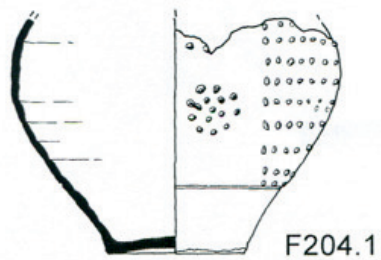
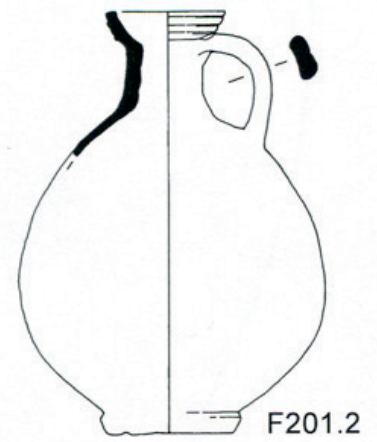
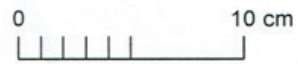
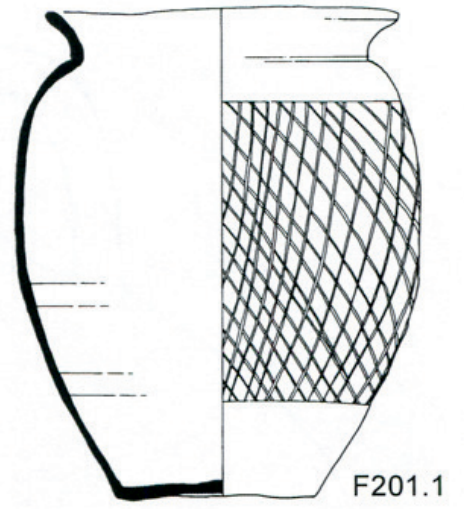
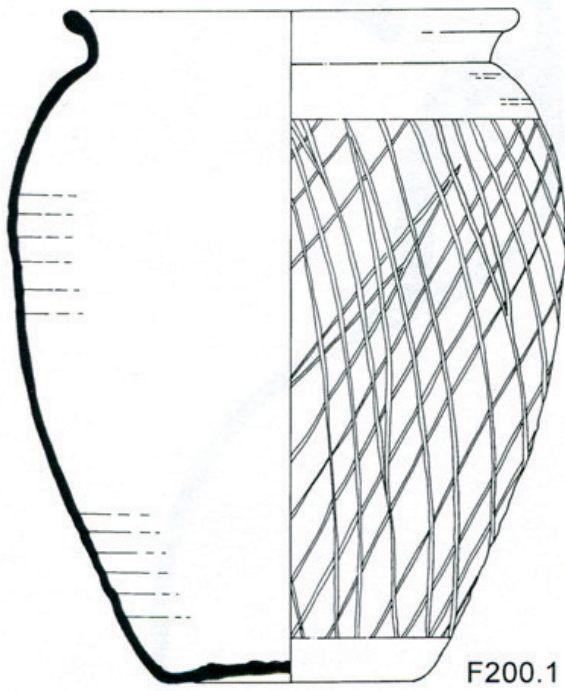
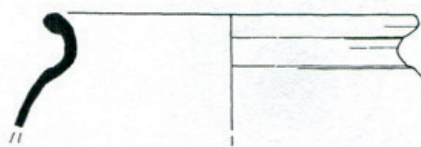
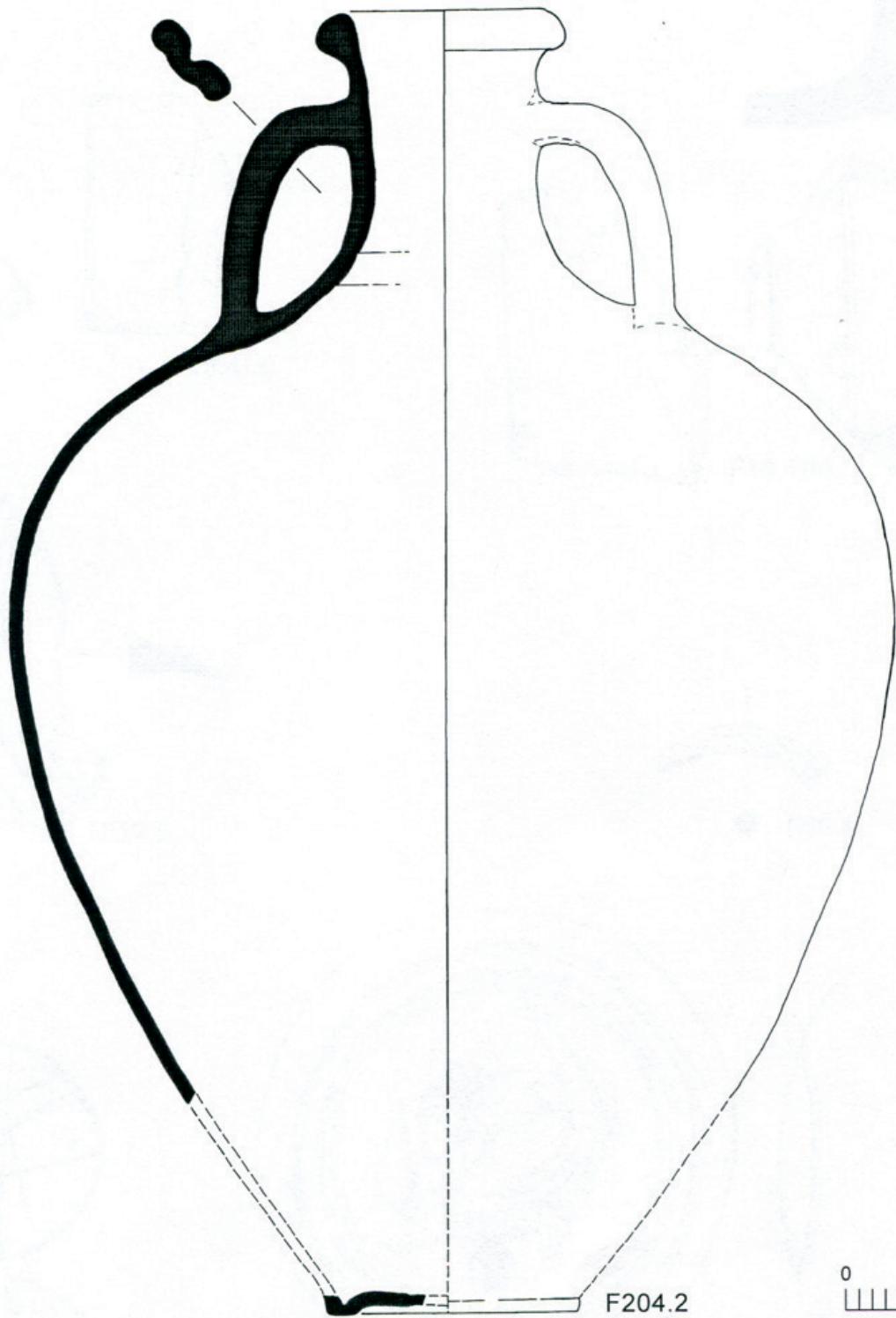
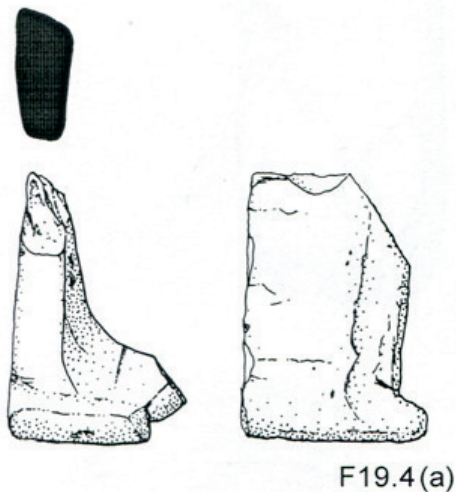


Fig 86 F200, F201, F204: pottery.

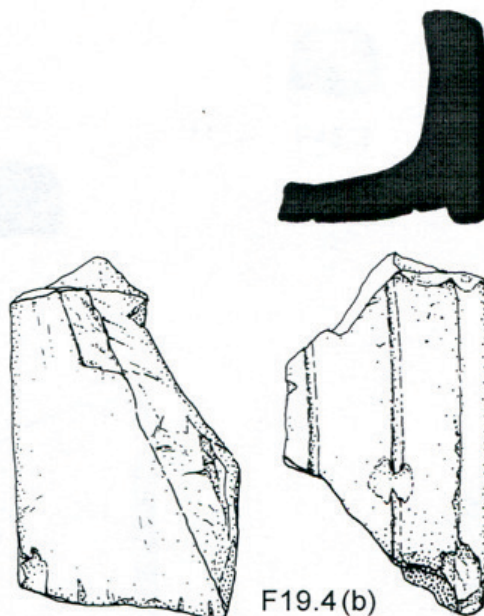


L3, T113
(finds no
1172)

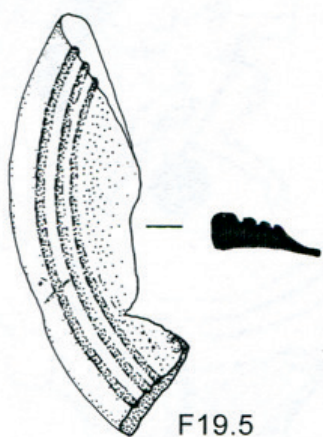
Fig 87 F204, L3: pottery.



F19.4(a)



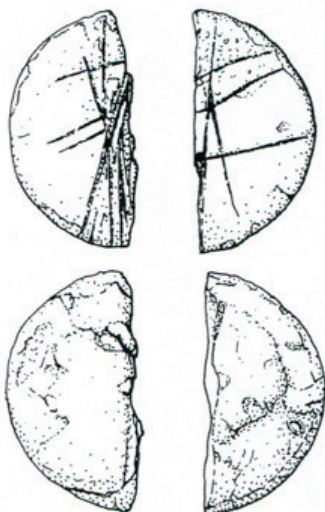
F19.4(b)



F19.5



F36.4



F53.9

F42.7



F42.6

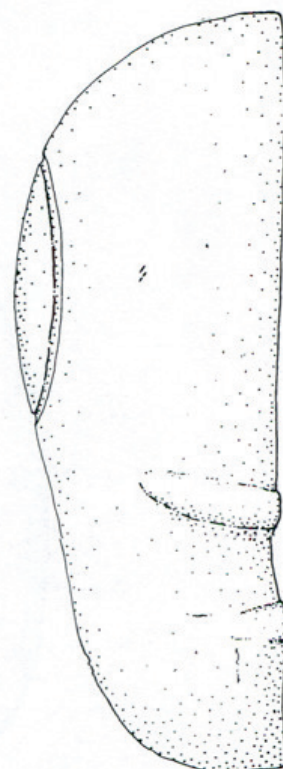
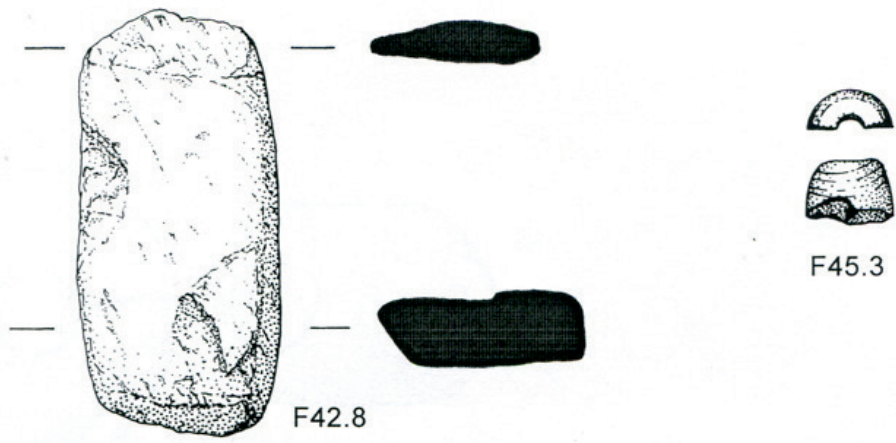


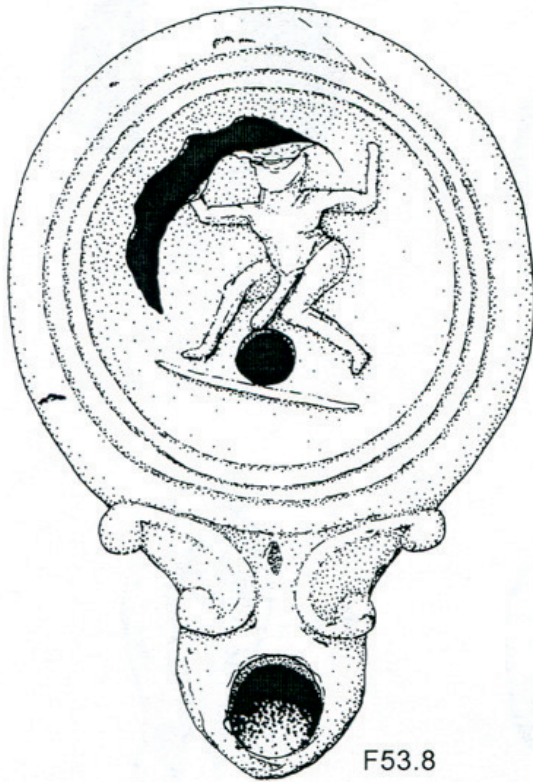
Fig 88 F19.4 *aedicula*; F19.5 lamp fragment; F36.4 ring;
F42.7 and F53.9 coin; F42.6 lamp.



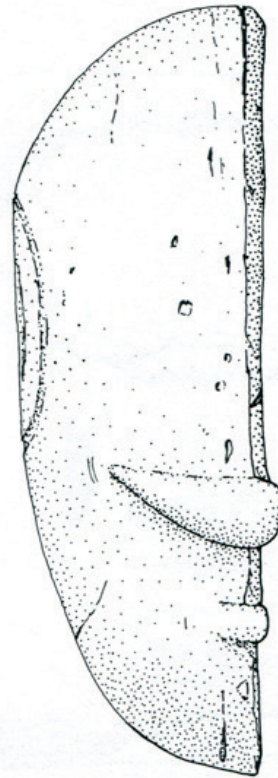


F42.8

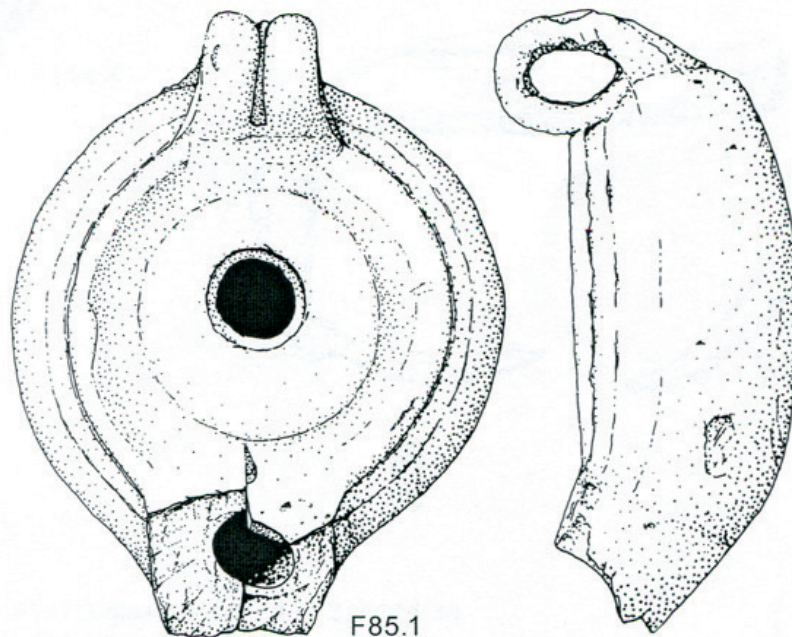
F45.3



F53.8



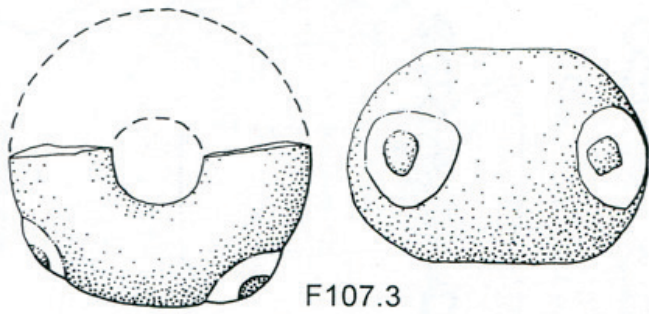
F53.15



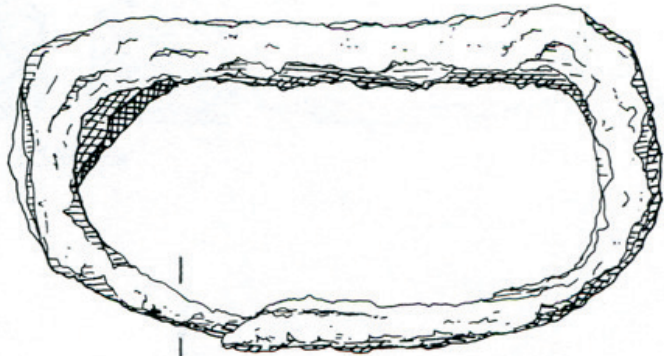
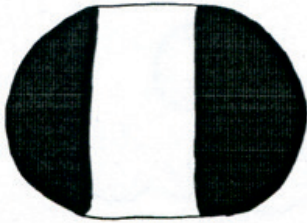
F85.1

Fig 89 F42.8 hone; F45.3 bone bead;
F53.8 lamp; F53.15 bone needle; F85.1 lamp.

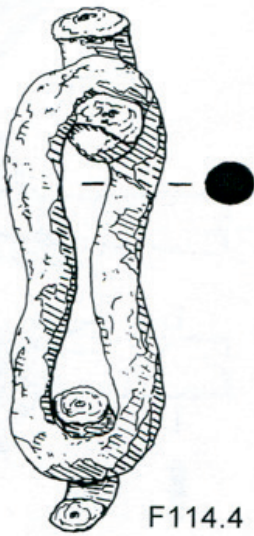




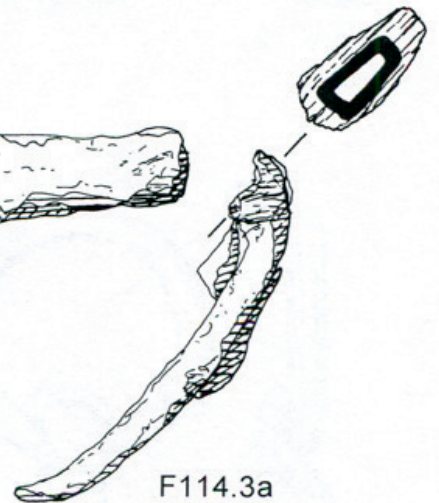
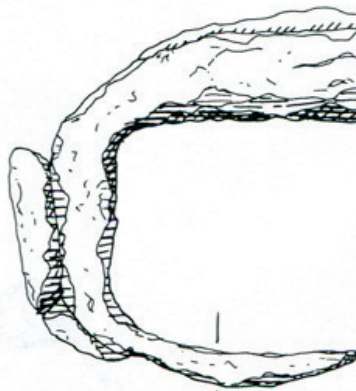
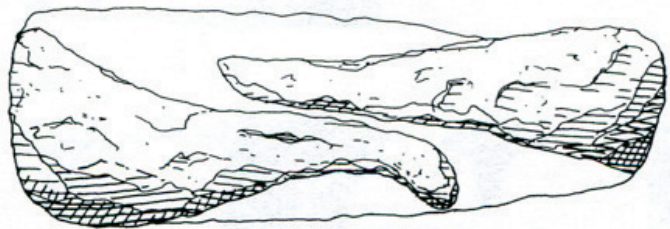
F107.3



F114.2



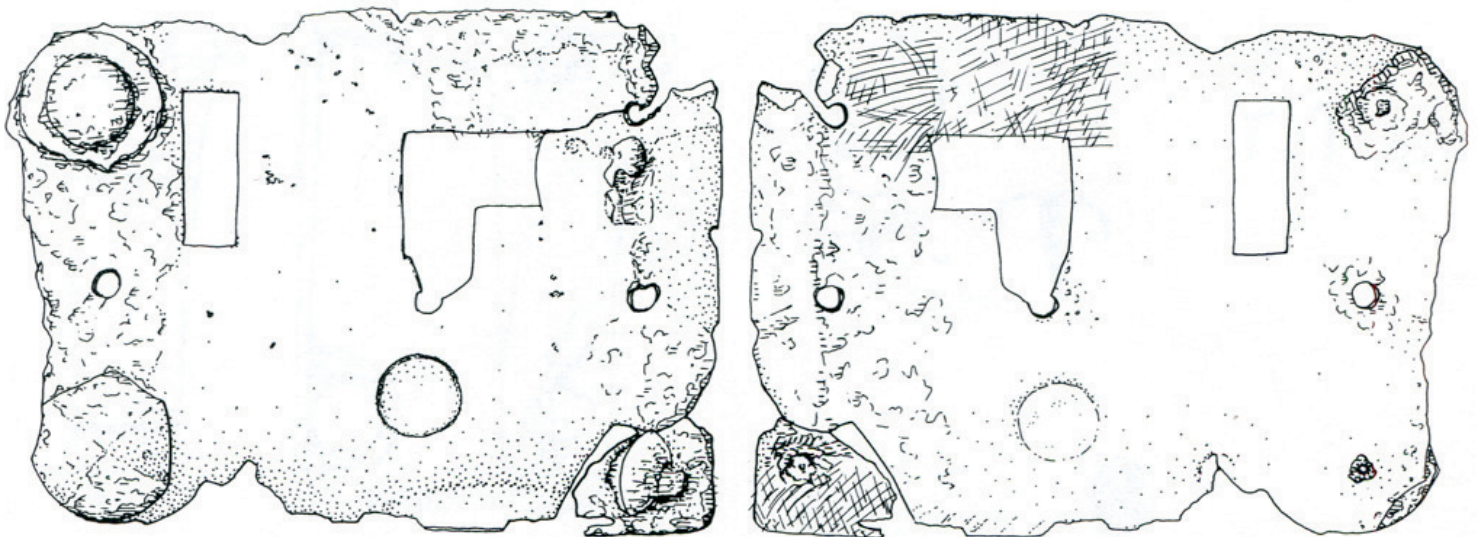
F114.4



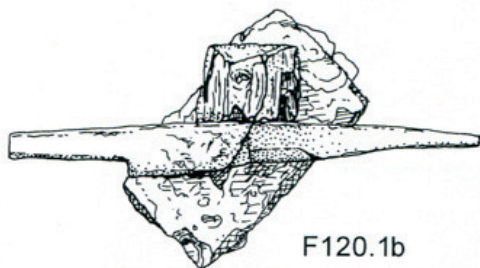
F114.3a

Fig 90 F107.3 glass bead; F114.2, F114.3a, F114.4 iron chain links.

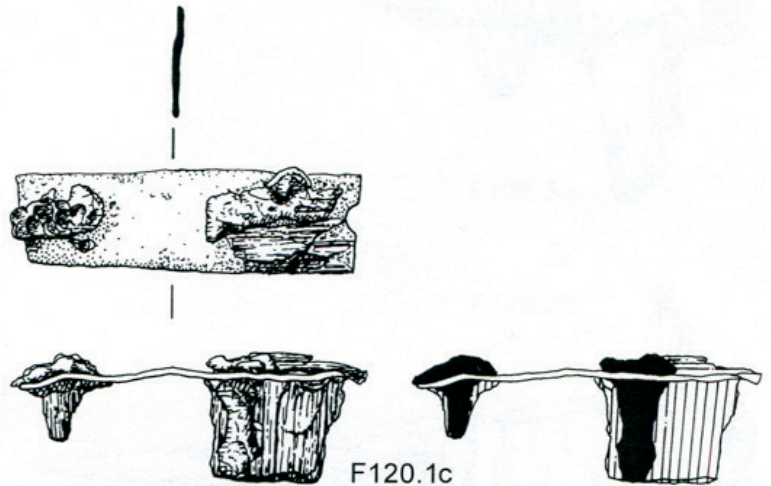




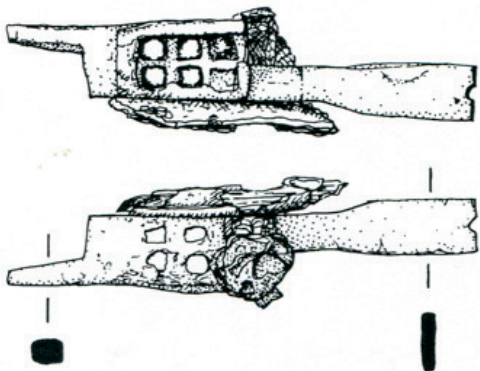
F120.1a



F120.1b

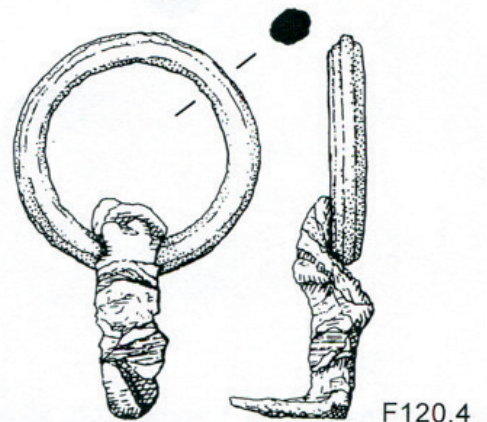


F120.1c



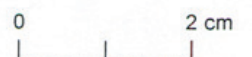
F120.2

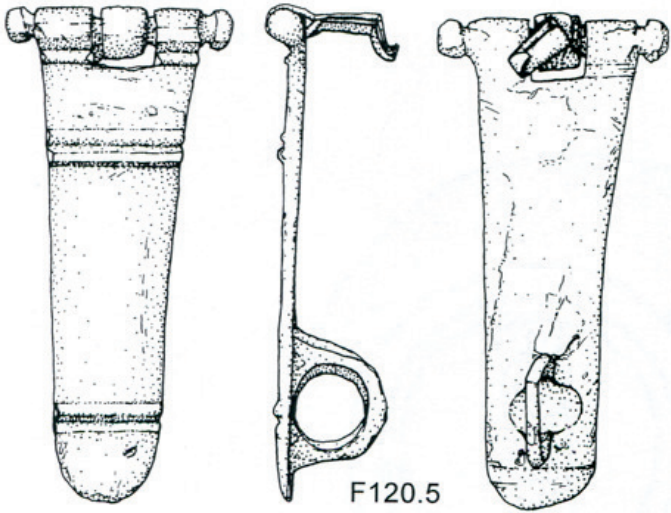
F120.3



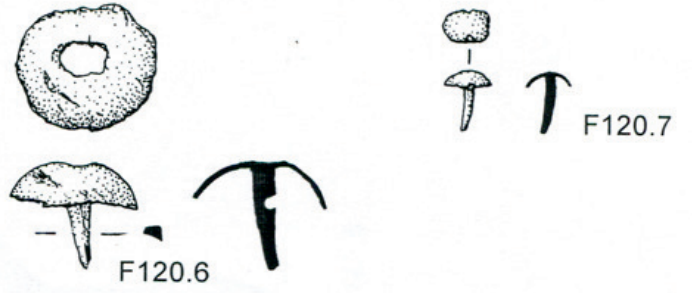
F120.4

Fig 91 Box fittings: F120.1 inner and outer face of lock plate, lock bolt, stud through wooden board; F120.2, F120.3, F120.4 ring hinges.



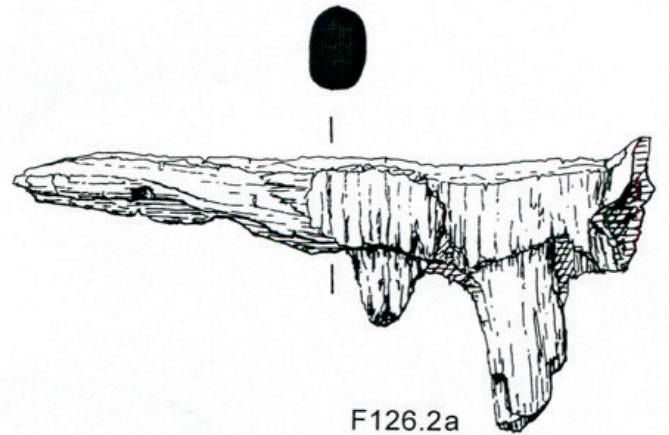


F120.5

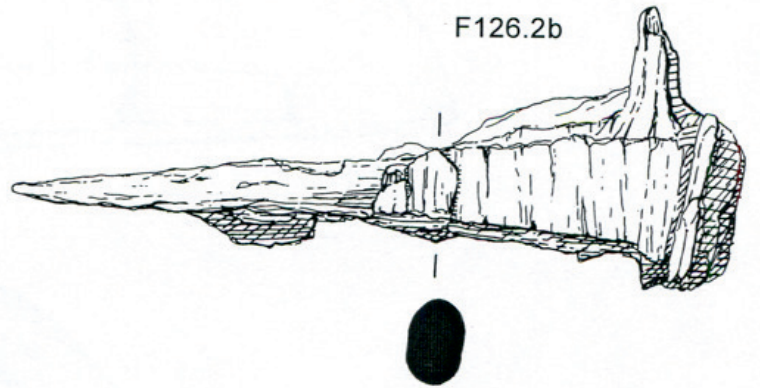


F120.6

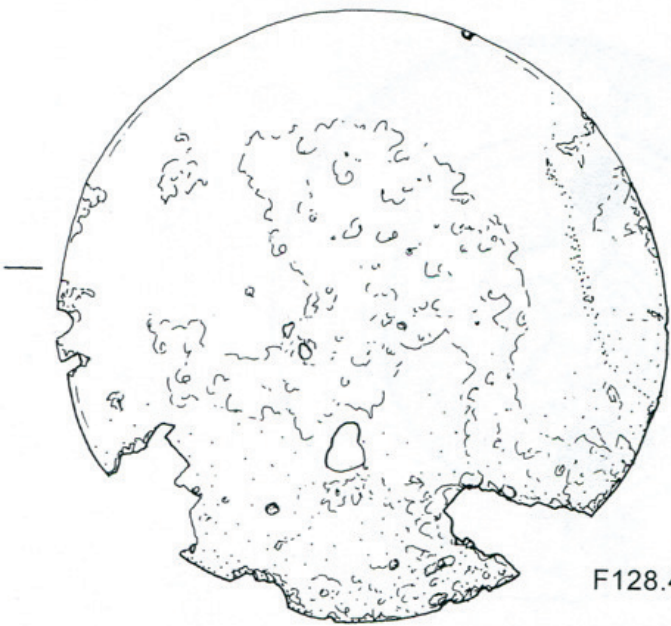
F120.7



F126.2a

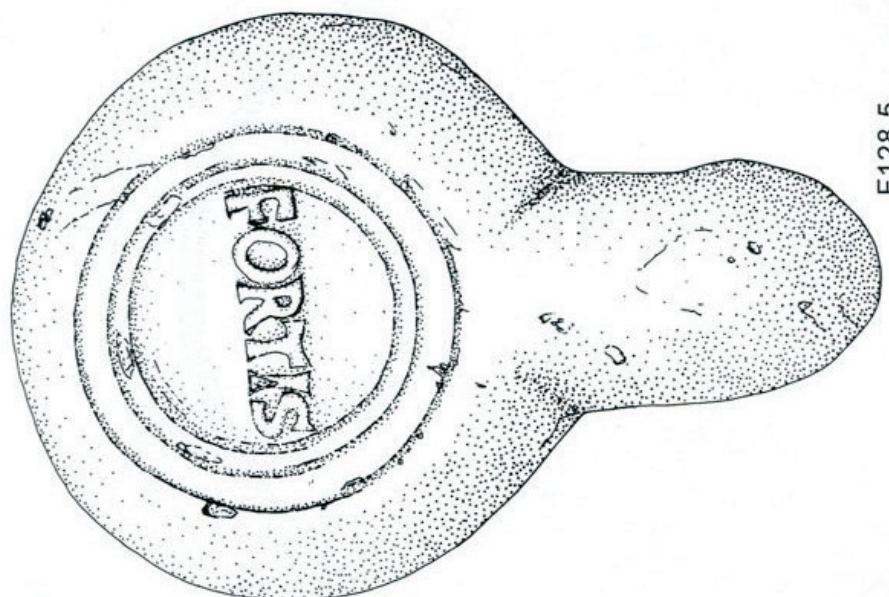


F126.2b



F128.4

Fig 92 Box fittings: F120.5 hasp, F120.6 and F120.7 studs; box fittings: F126.2 nails with mineralised wood; F128.4 mirror.



F128.5

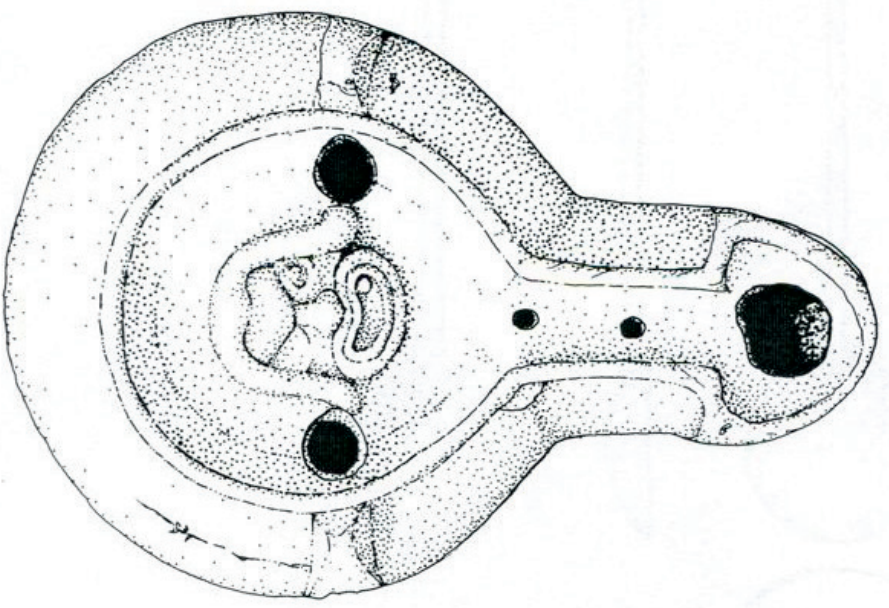
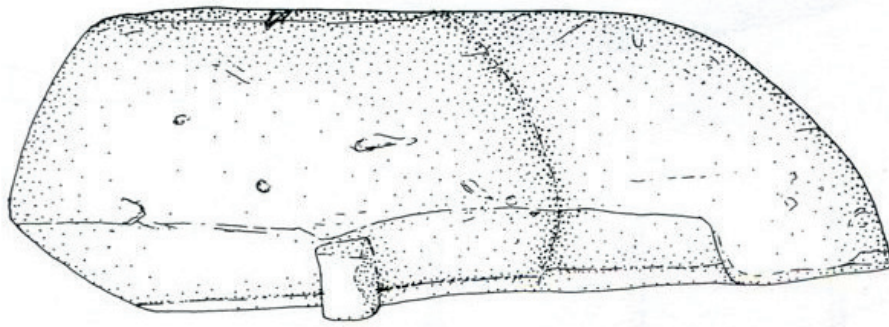


Fig 93 F128.5 lamp.

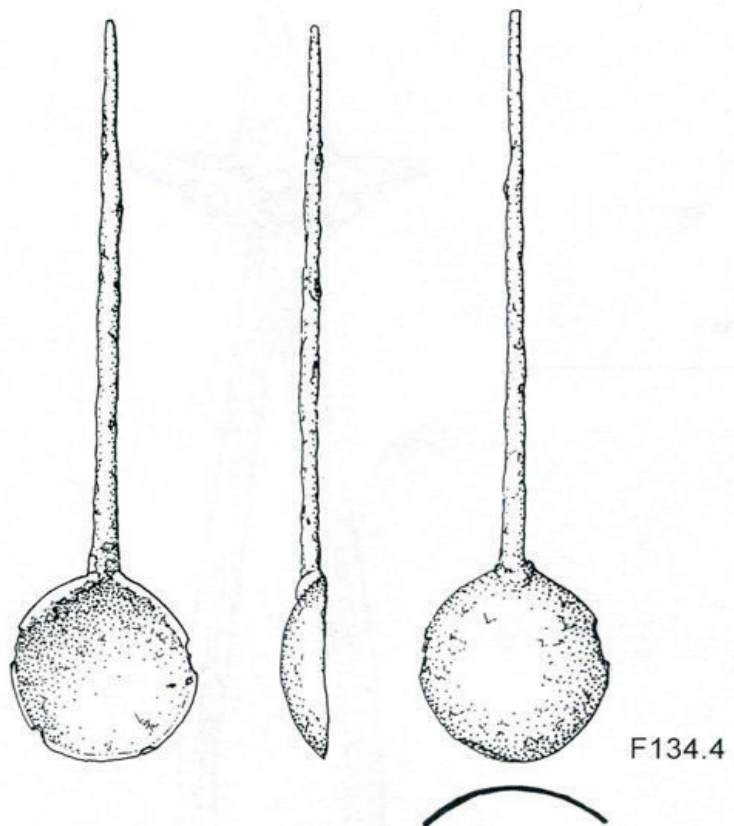
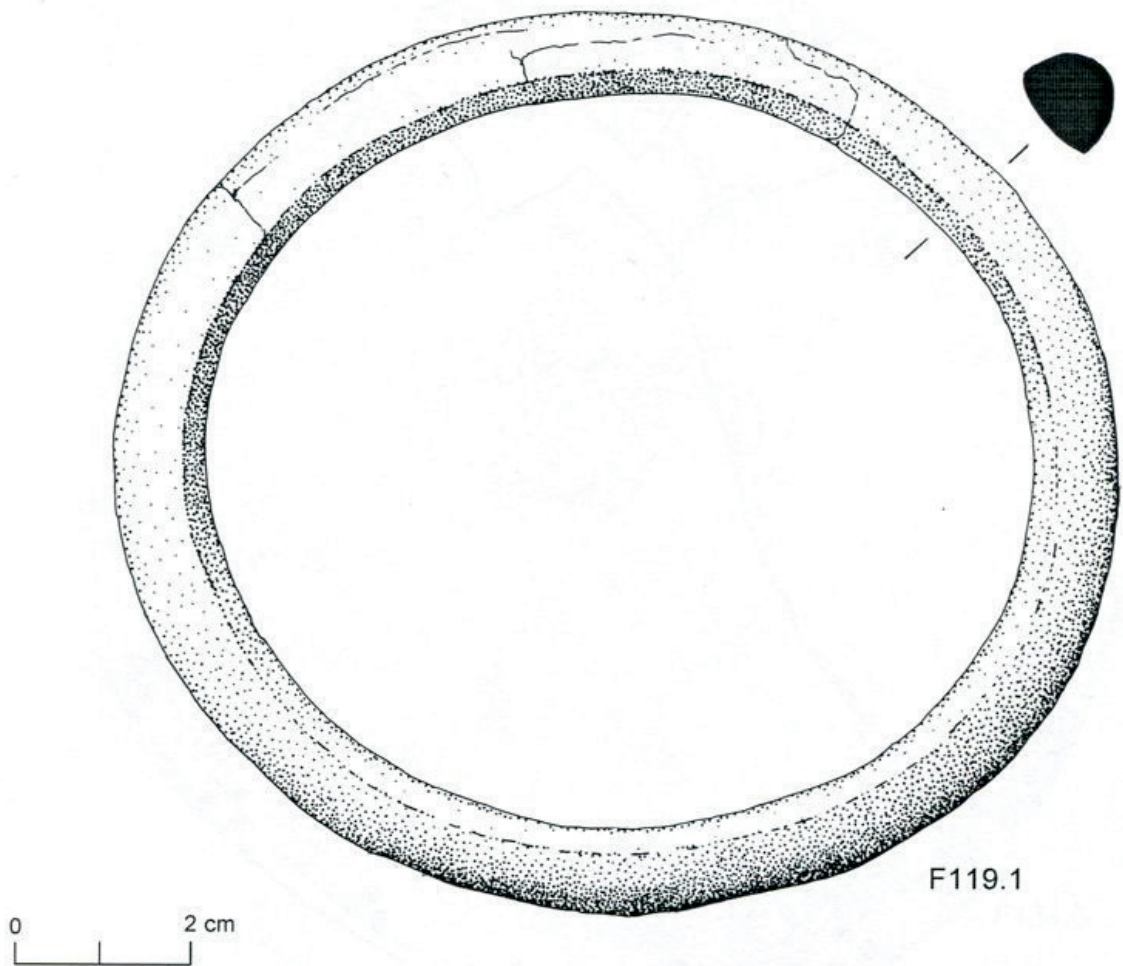
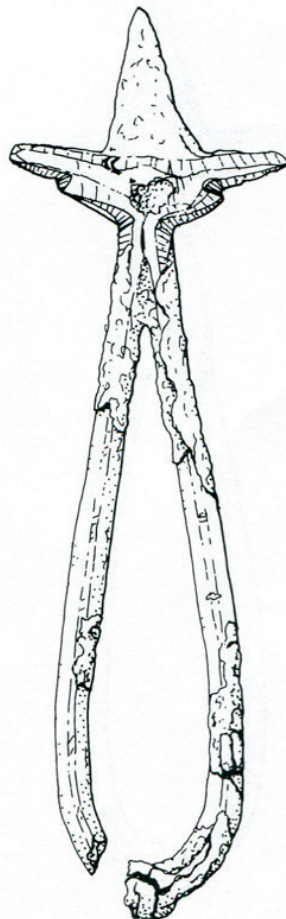


Fig 94 F119.1 shale armband; F134.4 copper-alloy spoon.



F134.5



0 2 cm

Fig 95 F134.5: reflecting side of mirror.

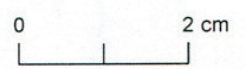
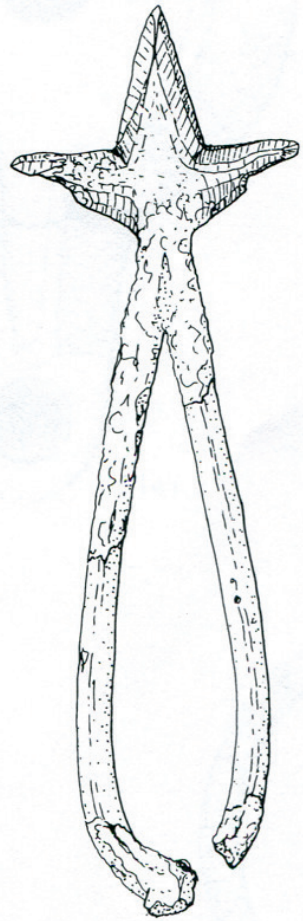
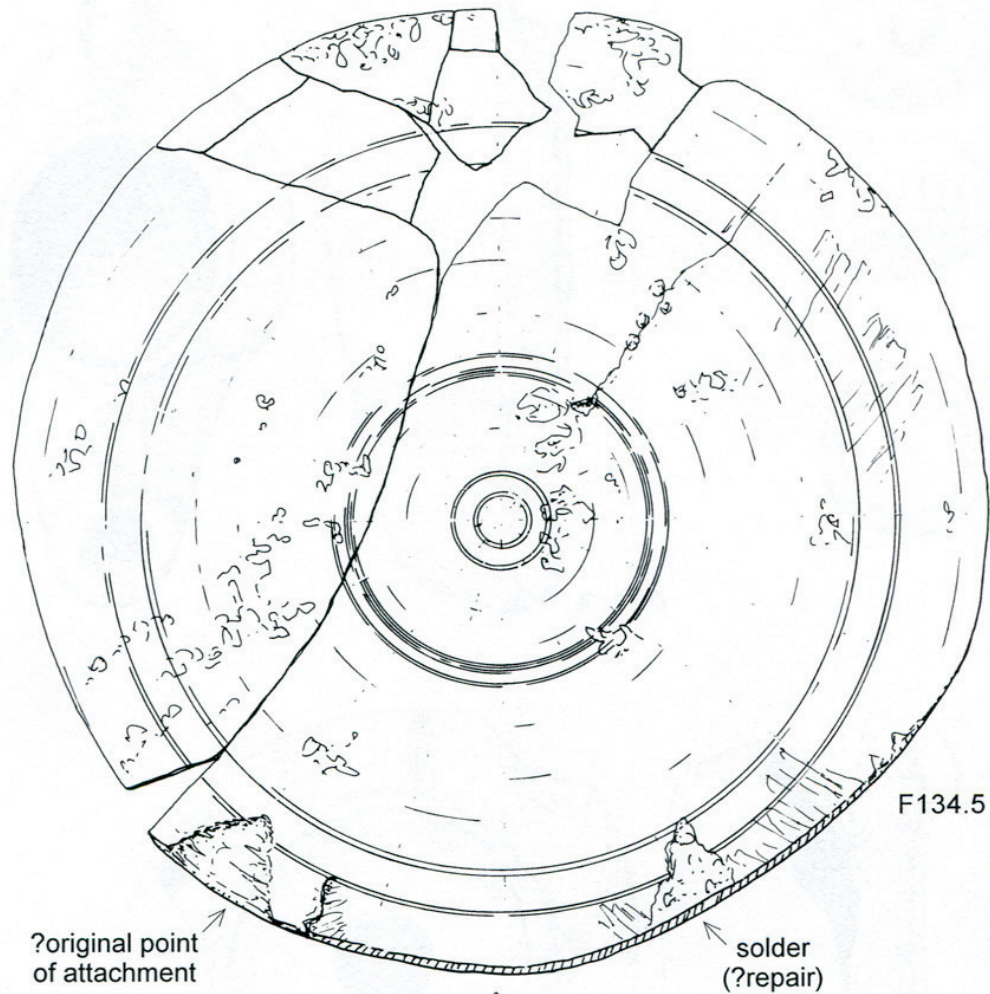
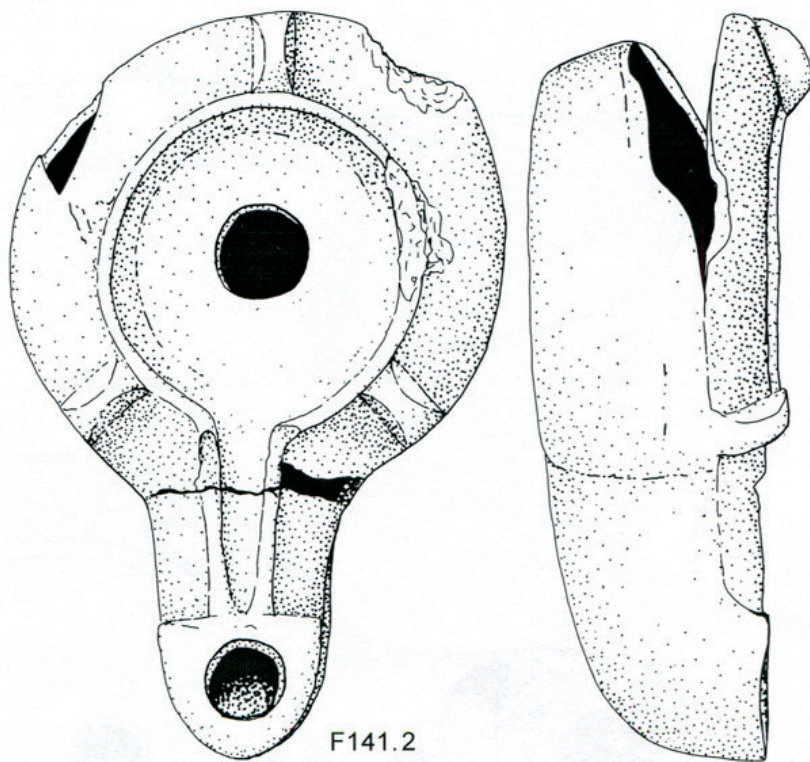
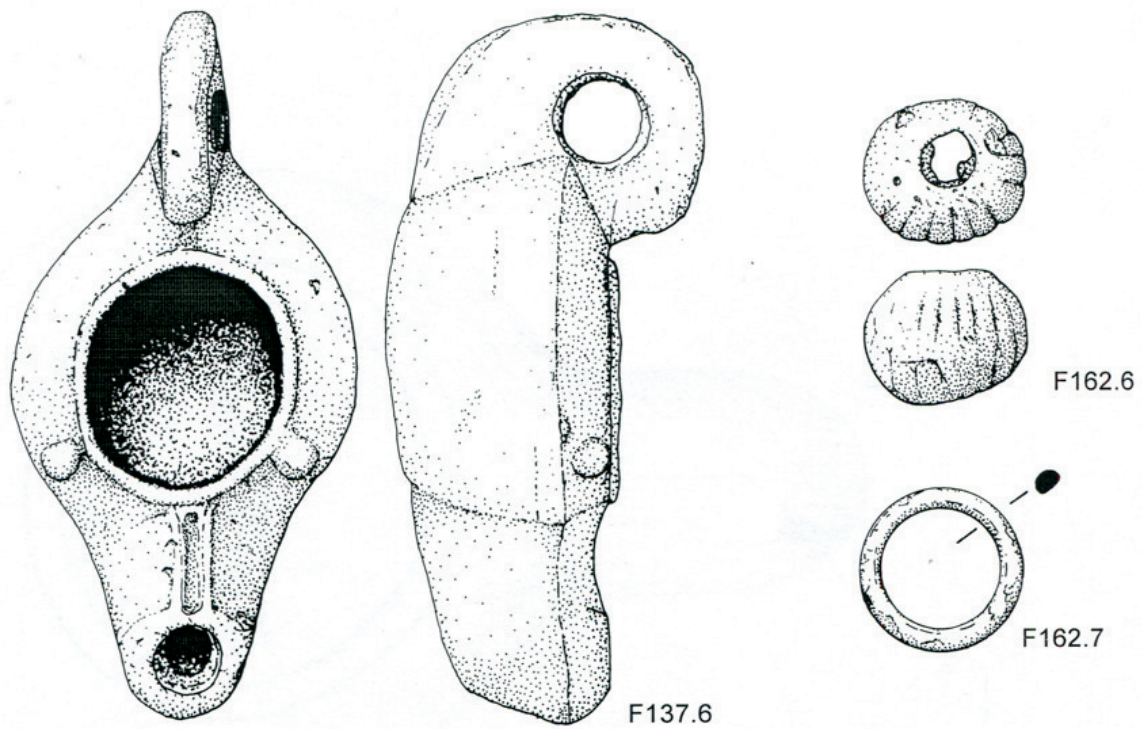


Fig 96 F134.5: rear side of mirror.



0 2 cm

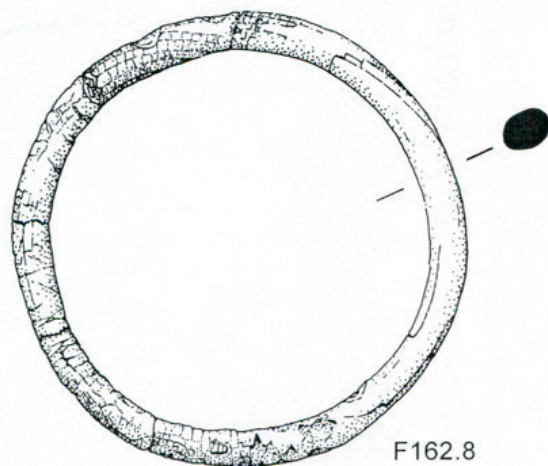
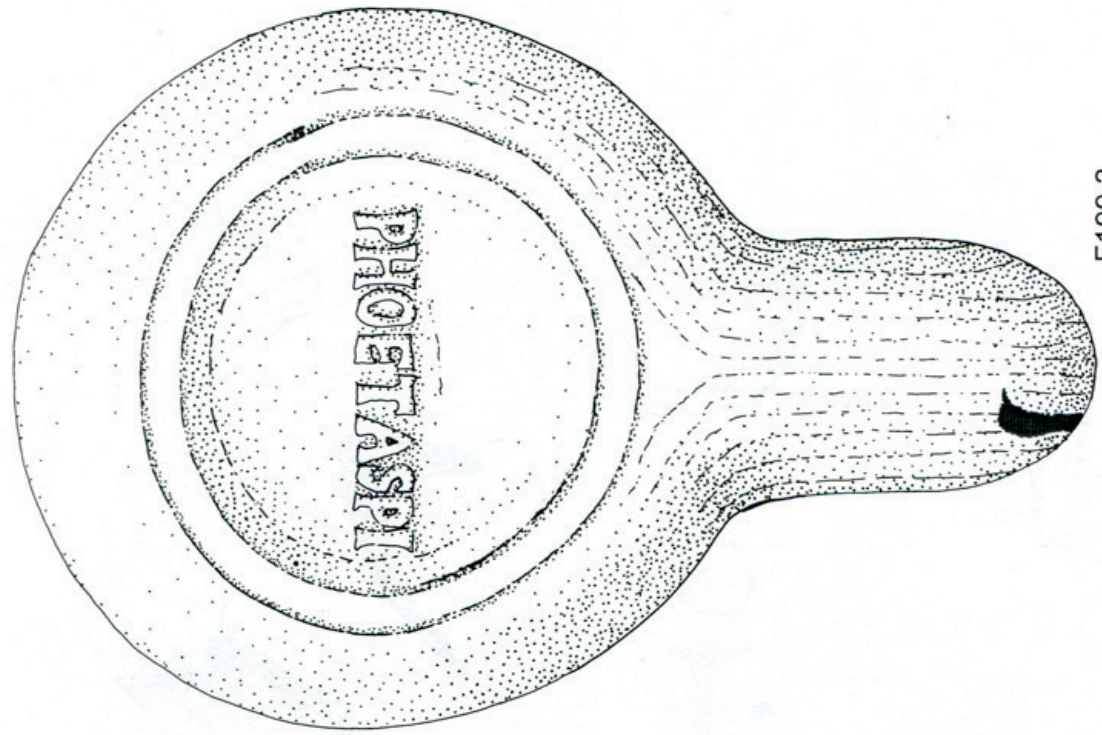


Fig 97 F137.6 lamp; F141.2 lamp;
F162.6 melon bead; F162.7
finger ring; F162.8 ivory armlet.



F199.2

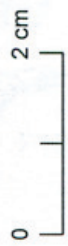
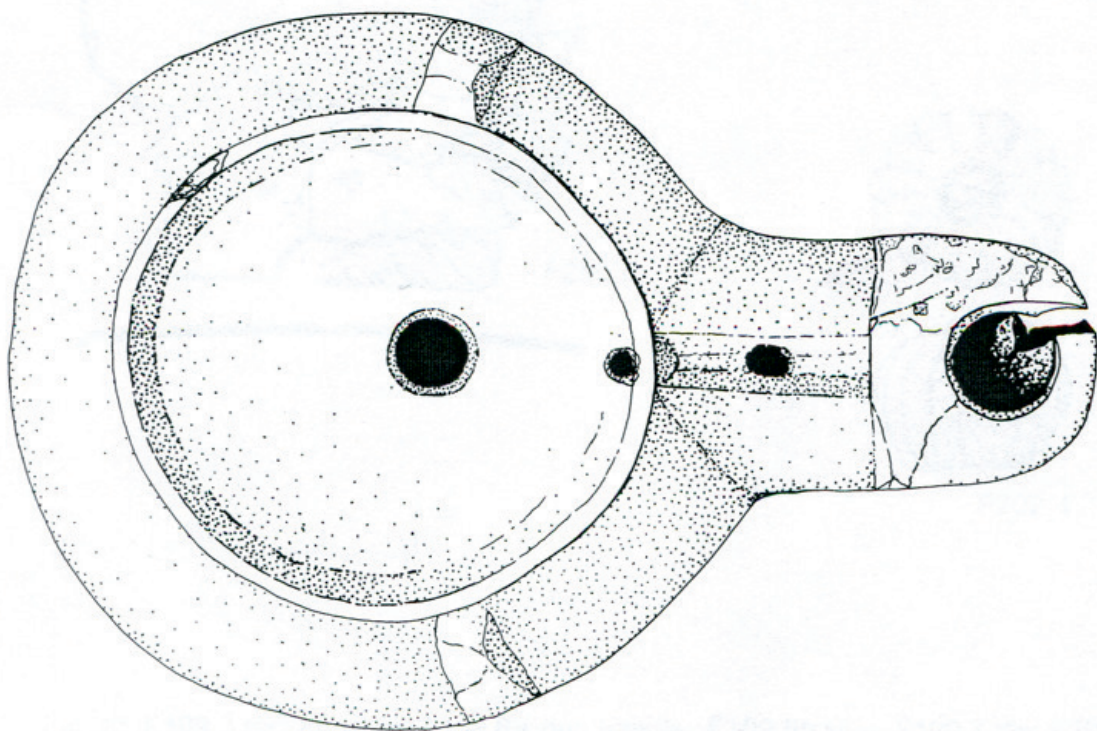
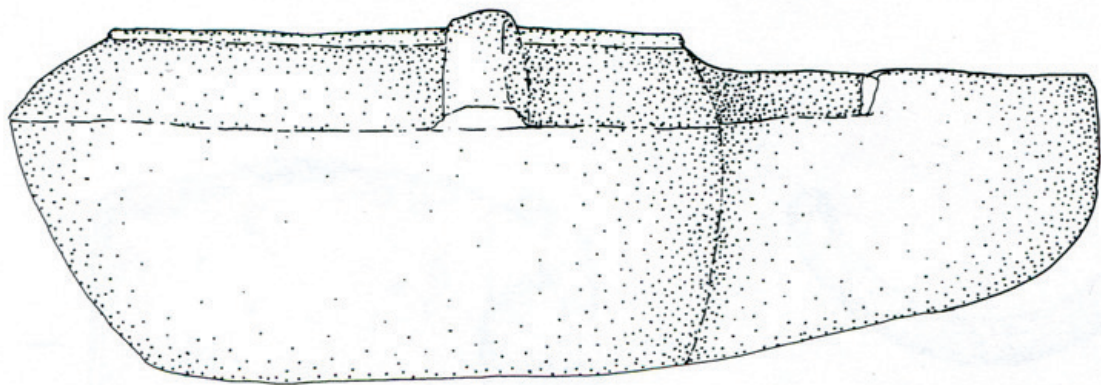


Fig 98 F199.2 lamp.

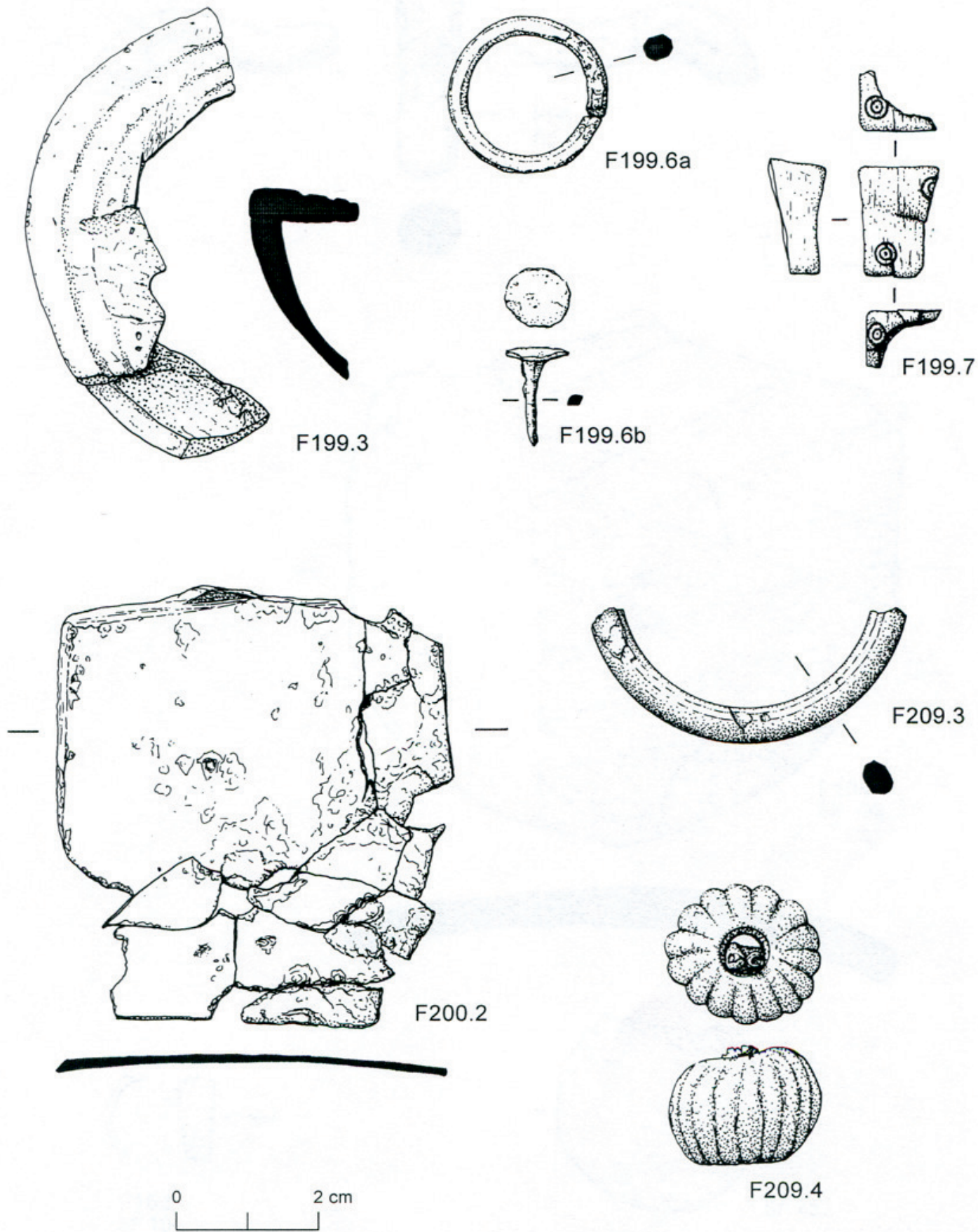


Fig 99 F199.3 picture lamp; F199.6a ring handle; F199.6b stud; F199.7 die; F200.2 mirror; F209.3 shale armlet; F209.4 melon bead.

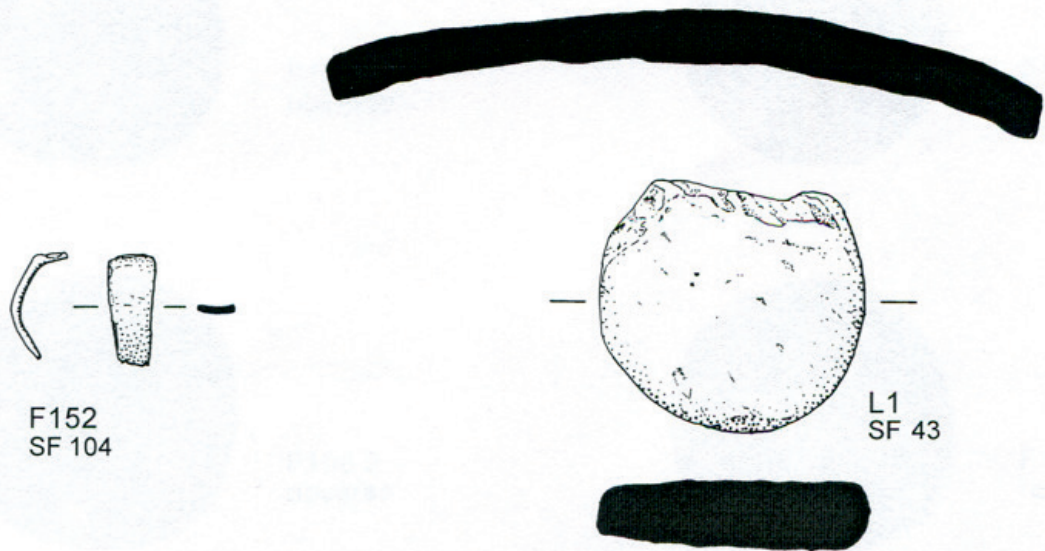
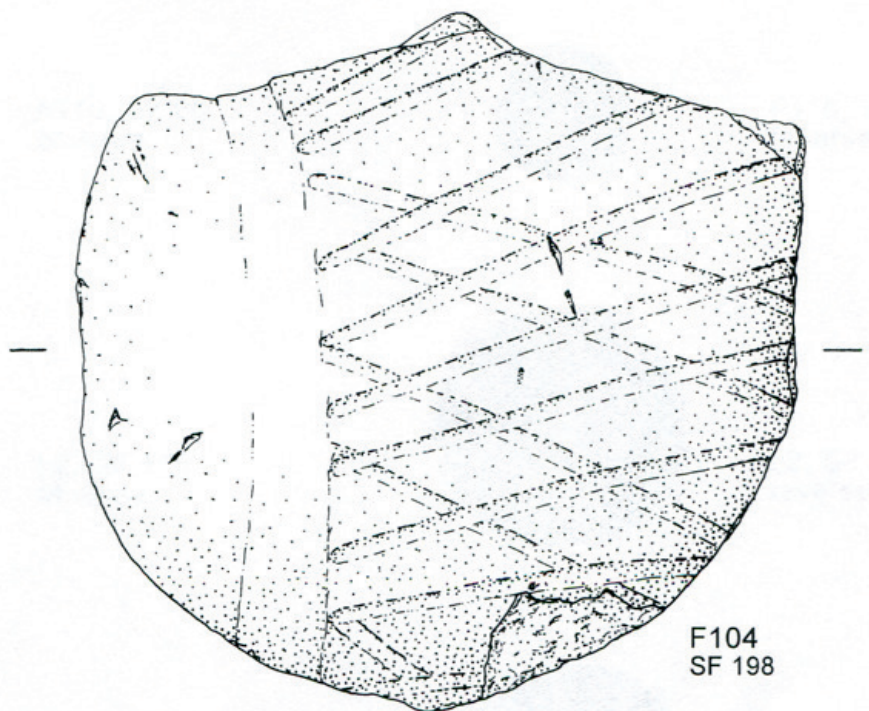
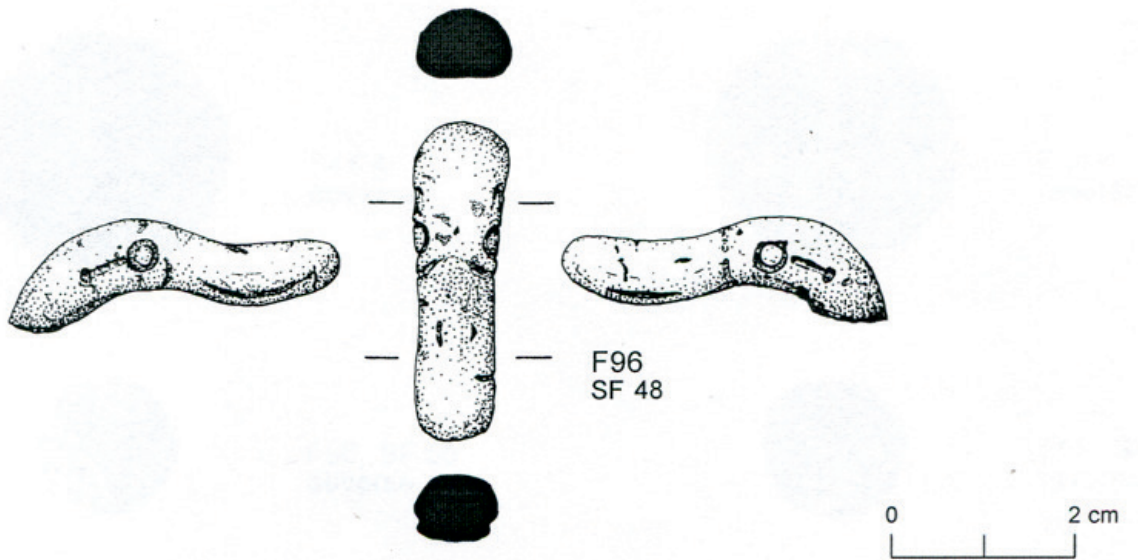


Fig 100 F96 swan's head terminal; F104 pottery counter; F152 finger ring; L1 pottery counter.



F44.4
obverse



F44.4
reverse



F98, SF 55
obverse



F98, SF 55
reverse



F110, SF 68
obverse



F110, SF 68
reverse



L2, SF 115
obverse



L2, SF 115
reverse



F197.3
obverse



F197.3
reverse



F198.2
obverse



F198.2
reverse

Fig 101 F44, F98, F110, L2, F197, F198: coins.



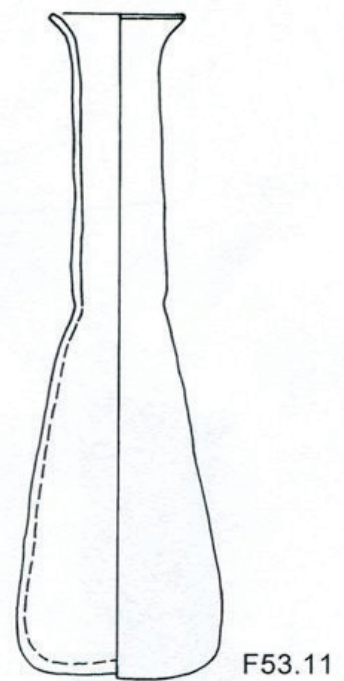
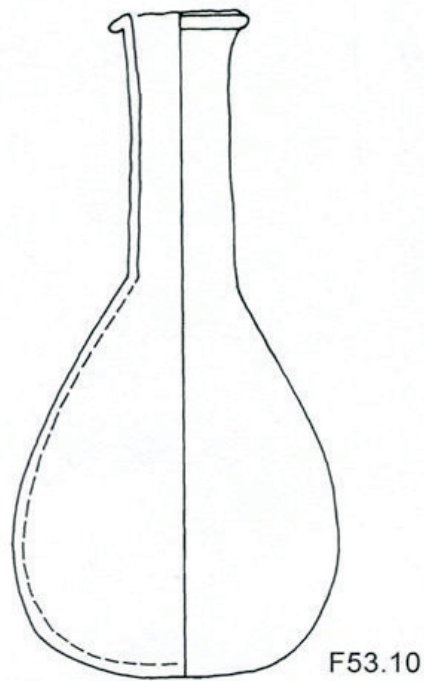
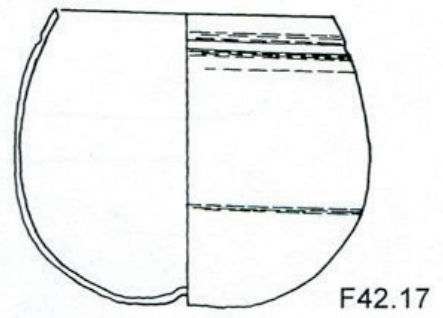
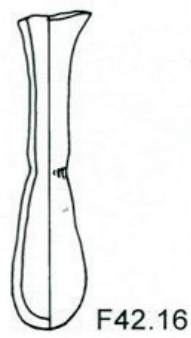
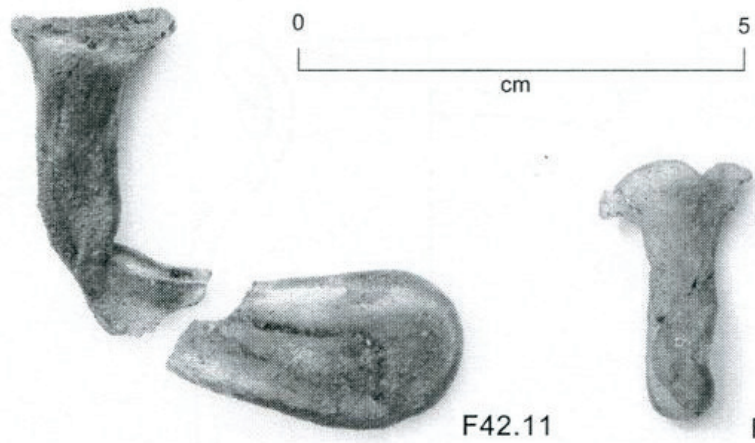
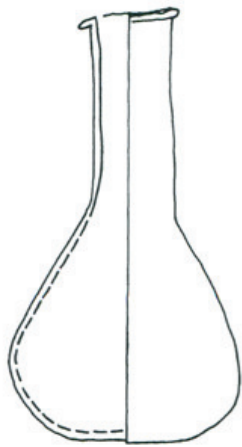
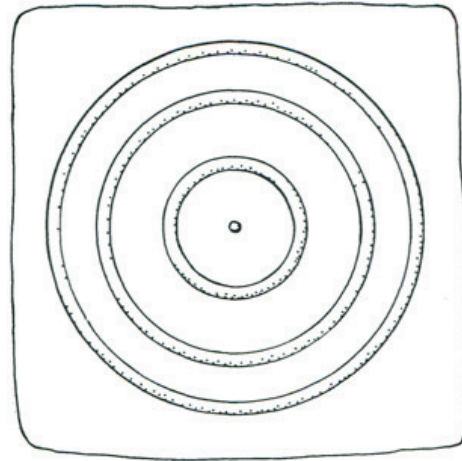
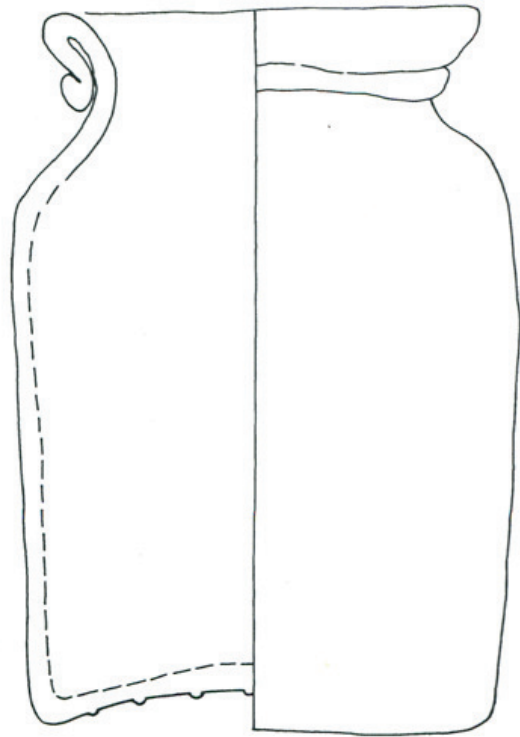


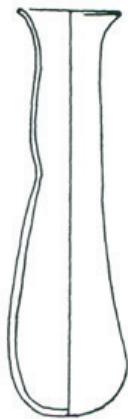
Fig 102 F42.11, F42.15, F42.16 glass unguent bottles; F42.17 glass Hofheim cup; F53.10, F53.11 conical glass flasks.



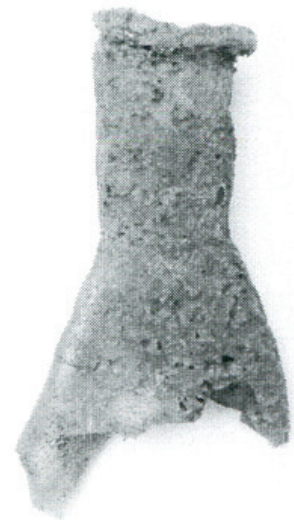
F53.12



F126.1



F142.4



F142.5

Fig 103 F126.1 glass jar/urn; F53.12 conical glass flask; F142.4, F142.5 glass unguent bottles.