

# Archaeological evaluation on land east of the Constable Country Medical Centre, Heath Road, East Bergholt, Suffolk, IP9 2LX

August 2017



by **Dr Elliott Hicks**

with contributions by Stephen Benfield, Laura Pooley and Lisa Gray  
figures by Sarah Carter and Ben Holloway

fieldwork by Nigel Rayner, Harvey Furniss, Jane Roberts, Adam Tuffey, Ziya Eksen  
and Gareth Morgan

**commissioned by Stephen Williams, Hills Residential**

NGR: TM 080 352 (centre)  
Planning ref: B/16/01092/OUT  
CAT project ref.: 17/08h  
Suffolk Parish Number: EBG 060  
Suffolk Event Code: ESF25709  
OASIS ref: colchest3-292177



## **Colchester Archaeological Trust**

Roman Circus House,  
Roman Circus Walk,  
Colchester,  
Essex, CO2 7GZ

tel.: 01206 501785  
email: [lp@catuk.org](mailto:lp@catuk.org)

**CAT Report 1164**  
October 2017

## Contents

1	Summary	1
2	Introduction	1
3	Archaeological and landscape background	1
4	Aims	3
5	Methodology	4
6	Results	4
7	Finds	8
8	Environmental report	14
9	Discussion	16
10	Acknowledgements	17
11	References	17
12	Abbreviations and glossary	18
13	Contents of archive	19
14	Archive deposition	19
	Appendix 1 Context List	21
	Appendix 2 Finds list	23

Figures after p26

Britannia Archaeology Ltd., *Land east of the Constable Medical Centre, Heath Road, East Bergholt: Detailed Magnetometer Survey. Report Number 1145: October 2016* (2016)

CAT wsi  
OASIS summary sheet

## List of photographs, tables, maps and figures

Cover: general site shot

Photograph 1	T5 trench shot, looking W	4
Photograph 2	T13 trench shot, looking SE	5
Photograph 3	T27 trench shot, looking SE	6
Photograph 4	T31 trench shot, looking S	6
Photograph 5	F10, looking NW	7
Photograph 6	F10, looking NNE	8
Table 1	Pottery fabrics	9
Table 2	Pottery from the fill of pit/quarry F9	11
Table 3	Results of metal-detecting survey by trench number	13
Table 4	Environmental results	15
Map 1	East Bergholt tithe map, 1837	16

Fig 1	Site location	
Fig 2	HER data (green) and listed buildings (blue) in relation to the development site (marked red).	
Fig 3	Evaluation results	
Fig 4	Detailed trench plans	
Fig 5	Detailed trench plans	
Fig 6	Detailed trench plans	
Fig 7	Feature and representative sections	
Fig 8	Feature and representative sections	

## 1 Summary

*An archaeological evaluation (sixty-one trial-trenches) was carried out on land to the east of Constable Country Medical Centre, Heath Road, East Bergholt, Suffolk in advance of the construction of a mixed-use development including up to seventy-five dwellings, a pre-school and a neighbourhood hub, associated infrastructure and landscaping. The evaluation followed a desk-based assessment and geophysical survey of the site. Twenty-eight features – either undated or originating from the post-medieval or modern periods – were uncovered, some of which represent the remains of a former field boundary detailed in historic mapping of the area.*

## 2 Introduction (Fig 1)

This report presents the results of an archaeological evaluation on land to the east of the Constable Country Medical Centre, Heath Road, East Bergholt, Suffolk which was carried out on 14th-25th August 2017. The work was commissioned by Stephen Williams, on behalf of Hills Residential, in advance of the construction of a mixed-use development including up to seventy-five dwellings, a pre-school and a neighbourhood hub, comprising a swimming pool, office space and a local shop, public open space, and associated infrastructure and landscaping, and was undertaken by Colchester Archaeological Trust (CAT).

The Local Planning Authority (Babergh District Council: Planning reference B/16/01092/OUT) was advised by Suffolk County Council Archaeology Service (SCCAS) that this site lies in an area of high archaeological importance, and that, in order to establish the archaeological implications of this application, the applicant should be required to commission a scheme of archaeological investigation in accordance with paragraphs 128, 129 and 132 of the *National Planning Policy Framework* (DCLG 2012).

All archaeological work was carried out in accordance with a *Brief for an evaluation at land east of the Constable Medical Centre, Heath Road, East Bergholt* detailing the required archaeological work written by Rachael Abraham (SCCAS 2017), and a Written Scheme of Investigation (WSI) prepared by CAT in response to the SCCAS brief and agreed with SCCAS (CAT 2017).

In addition to the brief and WSI, all fieldwork and reporting was done in accordance with English Heritage's *Management of Research Projects in the Historic Environment (MoRPHE)* (English Heritage 2006), and with *Standards for field archaeology in the East of England* (EAA 14 and 24). This report mirrors standards and practices contained in the Institute for Archaeologists' *Standard and guidance for archaeological evaluation* (CIfA 2017a) and *Standard and guidance for the collection, documentation, conservation and research of archaeological materials* (CIfA 2017b).

## 3 Archaeological and landscape background (Fig 2)

The following archaeological background draws on information from the Suffolk Historic Environment Record ([archaeology.her@suffolk.gov.uk](mailto:archaeology.her@suffolk.gov.uk)), SCC invoice number: 9187587.

### Geology

The Geology of Britain viewer (1:50,000 scale<sup>1</sup>) shows the bedrock geology of the site as Thames Group (clay, silty), with superficial deposits of Lowestoft Formation (sand and gravel).

### Historic landscape

Land to the east of the Constable Country Medieval Centre, Heath Road, East Bergholt is in an area defined as *plateau farmlands* in the Suffolk Landscape Character

<sup>1</sup> British Geological Survey – <http://mapapps.bgs.ac.uk/geologyofbritain/home.html?>

Assessment.<sup>2</sup> Within the Suffolk Historic Landscape Characterisation Map<sup>3</sup> it is defined as Landscape sub-type 10.3, built up area (village – substantial group of houses associated with a parish church). The landscape immediately around the development site is characterised as sub-type 1.1 (pre-18th-century enclosure – random fields); sub-type 1.4 (pre- 18th-century enclosure – irregular co-axial fields); sub-type 3.1 (post-1950 agricultural landscape (boundary loss from random fields); sub-type 5.1 (meadow or managed wetland –meadow); and sub-type 6.2 (horticulture – nurseries with glass houses).

There are no Heritage Assets within the proposed development site (PDS), but a list of all archaeological sites and finds within a 1km search area (radius) of the PDS can be found below (and on Fig 2). There are no listed battlefields, registered parks or gardens, or scheduled ancient monuments within the search area.

#### **Archaeology<sup>4</sup> (Fig 2)**

Distances listed below have been measured from the centre of the PDS to the centre of the heritage asset.

**Roman:** Roman finds include a domed-lead spindlewhorl (EBG 005; 903m NNW).

**Late Saxon:** The historic settlement core of East Bergholt dates from the Late Saxon period (EBG 044, 580-1271m E/SE).

**Medieval/post-medieval:** Medieval/post-medieval features (three ditches and two undated postholes) and finds were identified during a geophysical survey (ESF23261), a metal-detecting survey (ESF23262) and trial-trenching evaluation (ESF23263) on land northwest of Moores Lane (EBG 048, 920m NW)

**Post-medieval:** Old Hall Park (EBG 045), located 1230m SW, is shown on early OS maps as a large area to the southeast of Old Hall (EBG 023) with numerous trees.

**Modern:** Two 19th-century threshing barns are located at High Trees Farm (EBG 040, 680m NW)

**Undated:** An undated cropmark complex of 'ice-wedges and linear marks forming former ?field system on different alignments to present system' is located 970m SE (EBG 013). An undated and disarticulated human skull was also recovered during road widening opposite the Carriers Arms (EBG 008, 670m WNW).

**Metal-detected finds:** There are 49 confidential findspots within the search area, although none were located within, or in particularly close proximity to the PDS. The finds date from the Neolithic to post-medieval periods. The Neolithic flints, mostly from the same location, include flint blades, scrapers and flakes. A few fragments of copper-alloy working waste have been assigned a possible Bronze Age date and there was a large rim sherd of an Iron Age carinated bowl. All further evidence from these findspots is medieval and post-medieval in origin, largely comprising metalwork such as coins, buttons, harness straps and mounts, and finger rings.

#### **Listed buildings<sup>5</sup> (Fig 2)**

There are 41 designated listed buildings within the search area of Grade II and II\* status dating from the 15th- to the 19th-century. None of these are in particularly close proximity to the PDS (the nearest being c 350m to the southeast) or will be affected by the proposed development in anyway.

<sup>2</sup> <http://www.suffolklandscape.org.uk/>

<sup>3</sup> The Suffolk Historic Landscape Characterisation Map, version 3, 2008, Suffolk County Council

<sup>4</sup> This is based on records held at the Suffolk County Historic Environment Record (SCHER).

<sup>5</sup> This is based on records held at the Suffolk County Historic Environment Record (SCHER).



### **Desk-based assessment**

A desk-based assessment for the PDS was produced by Colchester Archaeological Trust in June 2016 (CAT Report 966). It summarised:

*Within the broader search area, the Suffolk Historic Environment Record (SHER) lists eight monuments. These include the findspots of a Roman spindle whorl and human skull of unknown date, a post-medieval timber framed pigeon loft and two 19th-century threshing barns.*

*One area of cropmarks is located to near the edge of the search area, to the southeast of the PDS. These appear to be largely glacial, though possibly also include marks relating to a former field system. Two areas of East Bergholt are identified by the HER as being areas of historic activity – one is the historic settlement core of the village and the other is the area of parkland known as ‘Old Hall Park’.*

*There has been one archaeological evaluation, near the edge of the search area, to the north-west of the PDS. Medieval and post-medieval finds and features were identified here during metal detecting and trial trenching.*

*As well as these listed monuments, 41 listed buildings and 49 confidential findspots are located within the search area. None of these are in close proximity to the PDS and any activity they indicate is unlikely to be affected by future development.*

### **Geophysical survey (Fig 3)**

A detailed magnetometer survey was carried out over the PDS in October 2016 by Britannia Archaeology Ltd (Report Number: 1145). It summarised:

*The geophysical survey identified several anomalies that could be archaeological in origin. The features present within the survey are identified as low amplitude positive anomalies, which could be infilled ditch type features (1000 – 1002 and 1004), with anomalies 1001 and 1002 possibly representing an enclosure. A series of low amplitude anomalies (1003) on the northern boundary of the site have been identified as ploughing activity of an unknown date. A discrete high amplitude anomaly (1006) was identified of unknown origin, it is possible that the source of the anomaly is archaeological in origin.*

## **4 Aims**

The aims of the evaluation were to:

- excavate and record any archaeological deposits that were identified within the development site.
- identify the date, approximate form and purpose of any archaeological deposit within the application area, together with its likely extent, localised depth and quality of preservation.
- evaluate the likely impact of past land uses, and the possible presence of masking colluvial/alluvial deposits.
- establish the potential for the survival of environmental evidence.
- provide sufficient information to construct an archaeological conservation strategy, dealing with preservation, the recording of archaeological deposits, working practices, timetables and orders of costs.

## 5 Methodology

Sixty-one trial-trenches were laid out across the development site. Fifty-six trenches measured 30m long by 1.8m wide, one 32m by 1.8m, one 28m by 1.8m, one 11m by 1.8m, one 22m by 1.8m and one 16m by 1.8m (totalling 1789m linear or 3220.2m<sup>2</sup>).

All of the trenches were mechanically excavated under archaeological supervision. All archaeological horizons were excavated and recorded according to the WSI. A metal detector was used to check trenches, spoil heaps and excavated strata.

## 6 Results (Appendix 1, Figs 3-8)

The trial-trenches were excavated through modern topsoil (L1, c 0.23m-0.62m) onto naturally-deposited soils (L2). In a number of trenches, subsoil (L3, c 0.06m-0.29m) and natural (subsoil) (L4), were encountered.

No significant archaeological remains were encountered in the following trenches: T1, T2, T3, T4, T6, T8, T10, T11, T14, T15, T17, T18, T19, T20, T21, T22, T24, T28, T29, T32, T34, T39, T40, T41, T42, T43, T44, T45, T46, T47, T48, T50, T51, T53, T54, T56, T57, T61.

**Trench 5 (T5):** Undated pit F13 measured 1.02m in width 0.23m in depth.



**Photograph 1** T5 trench shot – looking west

**Trench 7 (T7):** Undated possible pit F23 measured 1.85m in width and 0.13m in depth.

**Trench 9 (T9):** Undated ditch F24 was aligned NW-SE, and measured 0.58m in width and 0.14m in depth.

**Trench 12 (T12):** Undated ditch F17 was aligned NE-SW, and measured 0.82m in width and 0.07m in depth.

**Trench 13 (T13):** Modern pit/quarry F9 measured 10.24m in width and 1.66m in depth. Undated ditch F27 was aligned NNE-SSW, and measured 0.88m in width and 0.2m in depth.



**Photograph 2** T13 trench shot – looking southeast

**Trench 16 (T16):** Undated ditch F19 was aligned NW-SE, and measured 1.1m in width and 0.26m in depth. Undated ditch F20 was aligned NE-SW, and measured 0.56m in width and 0.1m in depth.

**Trench 23 (T23):** ?Post-medieval ditch F2 was aligned N-S, and measured 1.27m in width and 0.05m in depth.

**Trench 25 (T25):** Modern land drain F14 was aligned N-S, and measured 0.35m in width and 0.26m in depth.

**Trench 26 (T26):** Modern land drain F15 was aligned N-S, and measured 0.35m in width and 0.26m in depth.

**Trench 27 (T27):** Undated ?natural feature F28 was aligned N-S, and measured 2.96m in width and 0.59m in depth.





**Photograph 3** T27 trench shot – looking southeast

**Trench 30 (T30):** Undated natural feature F4 measured 1.13m in width and 0.09m in depth.

**Trench 31 (T31):** ?Post-medieval ditch F5 was aligned NW-SE, and measured 1.1m in width and 0.49m in depth.



**Photograph 4** T31 trench shot – looking south



**Trench 33 (T33):** Undated pit/posthole F1 measured 0.58m in width and 0.07m in depth. Modern ditch F3 was aligned NW-SE, and measured 1.3m in width and 0.16m in depth.

**Trench 35 (T35):** ?Modern pit F25 measured 0.6m in width and 0.09m in depth.

**Trench 36 (T36):** Undated ditch F18 was aligned NW-SE, and measured 2.3m in width and 0.55m in depth.

**Trench 37 (T37):** Undated natural feature F21 measured 1.85m in width and 0.17m in depth.

**Trench 38 (T38):** Undated natural feature F16 measured 1.42m in width and 0.22m in depth.

**Trench 49 (T49):** Post-medieval pit/linear feature F26 measured 1.07m in width and 0.21m in depth.

**Trench 52 (T52):** Post-medieval ditch F6 was aligned NNE-SSW, and measured 1.06m in width and 0.11m in depth.

**Trench 55 (T55):** Modern land drain F22 was aligned NW-SE, and measured 0.36m in width and 0.34m in depth.

**Trench 58 (T58):** Probable kiln F10 measured 5.4m in width and was excavated to a safe working depth of 0.8-1m. A slot was excavated for a further 0.5m, at which point a layer of bricks was uncovered, presumably in the base of the feature. Abundant brick fragments were found throughout the fill of the feature. It is likely a brick kiln although there is no documentary evidence of kilns in this location. A 'Brick Kiln Farm' and a 'Kiln Cottage' are located 1-2km northwest of the site, however.



**Photograph 5** F10 – looking northwest



**Photograph 6** F10 – looking north northeast

**Trench 59 (T59):** Post-medieval/modern ditch or pit F11 measured 3.8m and 0.7m in depth. Modern ditch or pit F12 measured 3.2m in width and 0.35m in depth.

**Trench 60 (T60):** Modern ditch F7 measured 1.7m in width and 0.45m in depth. Modern ditch F8 measured 2.24m in width and 0.17m in depth.

## 7 Finds

*by Stephen Benfield*

### Introduction

The evaluation produced finds of prehistoric, medieval, post-medieval and modern date. The earliest dated finds were two worked flints, one of probable Early Neolithic date. Two small abraded sherds of medieval pottery were also recovered. The majority of the finds consist of pottery and ceramic building material (CBM) dating to



the post-medieval and modern periods. Small quantities of other finds (glass, clay tobacco pipe, coal, charcoal, heat altered (burnt) stones, animal bone, oyster shell, recent agricultural iron and iron nails) are also present. The pottery was recorded using the Colchester post-Roman fabric series (CAR 7) and the fabrics recorded are listed in Table 1. There are three individually labelled small finds: a stone hone (SF1) which is an unstratified (US) find and not closely dated and two copper alloy buttons (SF2 and SF3) from F9 of c late 18th- or 19th- to early 20th-century date. All of these finds are listed and described by context in the finds catalogue (Appendix 2).

Fabric code	Fabric description
20	Medieval sandy greywares (general)
40	Post-medieval (glazed) red earthenware
40B	Stock-type black glazed ware
45	English stoneware
45D/E	German stoneware (Frechen/Cologne)
45M	Modern English stoneware
46A	English tin-glazed earthenware
48D	Staffordshire-type white earthenwares (general)
48E	Yellow ware
50	Staffordshire-type slipware
51A	Late slipped kitchen ware

**Table 1** Pottery fabrics

### Discussion

Finds predating the post-medieval and modern period are very few. The prehistoric material consists of two flints, one of probable early Neolithic date. Both come from topsoil in T19. There are also two small, abraded sherds of medieval greyware (Fabric 20) that probably date to c 13th to 15th centuries; one from topsoil (T50) and another residual in a modern feature (F12 in T59). One feature F13 (T5) is not closely-dated as only a few heat-altered (discoloured) flints and some charcoal were recovered from the fill. Otherwise, all of the features contain finds that are, or are likely to be, of post-medieval or modern date.

#### *Post-medieval and modern finds*

The largest finds group is ceramic building material (CBM), particularly pieces from bricks. Bricks and brick pieces were recovered from most excavated contexts, especially the pit/quarry F9 (T13) and the brick structure F10 (T58) postulated to be a kiln and referred to as such hereafter for ease of reference. The bricks recovered encompass several different types which appear to include types that can be dated to the post-medieval period (c 15th to 17th century) as well as unfrogged and frogged bricks that are probably of 19th- to early 20th-century date. The dating of the bricks is based on the typology in *Brick in Essex* (Ryan 1996, Appendix 1). CBM is frequently the only dated find or the latest-dated finds material associated with a number of the contexts. Pottery is less common among the finds, although a moderate quantity was recovered from the fill of pit/quarry F9 (T13) and one or a few sherds were recovered from some of the other features. Other dating material includes a few pieces of clay tobacco pipe and glass bottles.

#### *Ceramic building material (CBM)*

Peg-tile pieces (mostly quite broken-up small-medium size pieces) are quite common among the finds but are not more closely dated than as medieval (probably after c 1300) to post-medieval/modern.

Potentially the earliest of the more closely-dated CBM are pieces of brick, about 45mm and 50-55mm thick, that have a grey glaze. These were recovered from F6 (T52) and are likely to date to the period of the 15th to early 17th century. Small pieces of coal also came from the same feature. Many of the more closely-dated brick pieces are of 18th- to 19th- century or 19th- to early 20th-century date. Among the more complete wall bricks there are three main types, unfrogged white bricks,

unfrogged red bricks and frogged red bricks.

The white bricks (none complete) come in a range of fabric colours varying from pale cream to pinkish-buff. These are represented by a few pieces from linear feature F8 (T60) and the kiln structure F10 (T58). They appear probably to be 'Suffolk whites' which were current between the 16th and 19th centuries but most common in the 19th century. The thickness of the pieces from F8 (55mm) could indicate a 17th- to 18th-century date while the pottery from this feature includes sherds dated to the 18th to 19th century. The pieces from F10 are thicker (c 65 mm-68 mm) and are almost certainly of 19th-century date. F10 contains other brick finds dated to the mid-19th to early 20th century.

Pieces of red bricks, including large parts of bricks and near whole bricks, are represented by both frogged and unfrogged types, and there are many other smaller pieces of similar red brick from several of the features on the site. A complete unfrogged red brick (230 mm x 115 mm x 68 mm) weighing 3308g was recovered from F10 (38) and is dated as 19th century or early 20th century. Other large brick pieces from this feature have parts of a rectangular frog (catalogued as Type 1) all of identical form and clearly moulded. No other frog types were found to be present. These brick pieces are commonly about 65 mm thick and can be dated to the late 19th to early 20th century. Two pieces of grey, cement based mortar were also recovered from this feature (39) with a positive impression of parts of this type of frog; although some brick pieces from this feature have white lime base mortar on their surfaces (53). A single soft piece from the end of a red brick was also recovered from F10 (50). This appears to have been moulded but not fired to any significant degree and appears to represent a 'green' brick. One or two brick pieces from the kiln structure F10 (T58) and land drain F22 (T55) have sooting on one side or on the brick end. A piece of thick, curving tile from large pit/linear feature F11 (T59) also has a soot-blackened interior surface and is possibly part of a chimney.

Other brick types include a small number of relatively thin bricks (brick pieces), one in yellow-buff fabric from pit/quarry F9 (T13) and several red-brown in colour from land drain F22 (T55). These are 40mm and 45mm thick, the upper surface of the pieces from F22 being worn, and can be identified as floor bricks, broadly dating to the 19th century, although that from F9 could possibly date earlier. There is also part of a hearth of flooring tile with a blackened, sooted surface which comes from the fill of drain F14 (T25). This is 45mm thick and the side length is greater than 140mm. A piece of red brick from the drain fill which is 65 mm thick can be dated as probably 19th to early 20th century.

Other CBM includes one piece of tile with what appears to be a refined fabric from pit/quarry F9 (59) (T13) and is probably of 19th- to early 20th-century date, while another tile piece, also from F9, is identifiable as pan-tile and certainly dates to after the 16th century. There is also a piece of smooth-surfaced modern ceramic pipe (dated late 19th to early 20th century) from the same feature. Of note are several pieces from pottery 'horseshoe' land drains which come from the fill of the linear or large pit feature F11 in T59, other finds from which are dated c 17th to 19th century. These have a small foot on the base edge at each side.

### *Pottery*

One or a few sherds of post-medieval and/or modern pottery were recovered from several features and from topsoil on the site. The only group of any size was recovered from the fill of the pit/quarry F9 (59) in T13. The most common of the pottery recovered is sherds of glazed red earthenware (Fabric 40) which has a wide currency, primarily over the period of the late 16th to late 18th century, stoneware sherds, mostly probably English stonewares of 17th- to 19th-century date (Fabric 45 and Fabric 45M) and modern factory wares of late 18th- to early 20th-century date (Fabric 48D). Sherds of Fabric 40 are the latest-dated find from pit F26 (T49) and late-dated stoneware was the

latest-dated pottery from the land drain in T55, although elsewhere these types of pottery were accompanied by modern factory wares dated to after the late 18th century.

#### *Pottery from pit/quarry F9*

The pottery collected from F9 is summarised in Table 2. In total there are 26 sherds with a combined weight of 454 g. This is recorded as all from the lower fill (find number 59).

Fabric	Sherd no	Weight/g	Notes
Fabric 40	18	406	includes sherds from large dishes/pancheons, bowl and large jar, c late 16th- to late 18th-century
Fabric 46A	4	18	includes speckled fabric handled bowl/mug, probably c late 17th- to 18th-century
Fabric 48D	2	4	c mid 18th- to 19th-century
Fabric 50	1	14	c late 17th- to 18th-century
Fabric 51A	1	12	c 19th- to early 20th-century

**Table 2** Pottery from the fill of pit/quarry F9

The majority of the pottery consists of glazed red earthenware (Fabric 40) broadly of late 16th- to late 18th-century date or slightly later. There are also several sherds of tin-glazed ware, including a sherd in a speckled glaze dated to the late 17th to 18th century (CAR 7, 244). A single sherd of Staffordshire slipware is of similar date (late 17th- to 18th-century). The latest dated pottery are two sherds of Staffordshire-type factory produced earthenware (Fabric 48D) dating to after the late 18th century and a sherd of late slipped kitchen ware (Fabric 51A) of 19th- to early 20th-century date. As a group the pottery appears slightly dysfunctional. The majority suggests a date in the late 17th to 18th century, supported by pieces from a glass bottle of probable 18th-century date; however, the three later-dated pottery sherds would indicate the lower fill dates to at least the late 18th or more probably the 19th century. These later sherds might be intrusive – although it can be noted that a piece of modern ceramic pipe, probably of late 19th- or early 20th-century date is also recorded as from the lower fill.

#### *Other finds*

Other finds appear only in small quantities and add little to the dating of the features, although one or two call for some comment.

Of note are a few pieces of clay tobacco pipe stem of post-medieval or modern date. Plain pieces of stem were recovered from F9 (upper fill) (T13), F10 (T58) and F11 (T59), while a decorated piece of probable 19th-century date was recovered from F3 (T33).

A small group of sherds of thick green bottle glass was recovered from the lower fill of F9 (T13) and is dated as probably late 17th to early 19th century. Two flat pieces appear to be window glass. A similar sherd of thick green bottle glass was recovered from F7 (T10) while two sherds from bottles more typical of the 19th to early 20th centuries were recovered from F10 (T58).

Only a few pieces of animal bone were recovered. A piece from a longbone with badly degraded surfaces and single sheep tooth were recovered from the lower fill of F9 (T13) and a small undistinguished bone piece came from the fill of F10 (T58). The indications are that bone is poorly preserved on the site.

#### **Discussion**

There appears to be some activity here in the Neolithic period, but the single closely-dated worked flint (one of only two pieces recovered) at present would suggest this is quite limited and ephemeral. There also appears to be some activity in the high medieval period (13th- to the 14th- or 15th-century), but again the evidence (limited to two small pieces of abraded pottery) indicates this is quite limited and the area is

peripheral to that of settlement or any concentrated activity. Some of the peg-tile pieces might be medieval, although even if they were, they would not significantly alter this picture. In terms of the finds, no features that can be closely dated to the prehistoric or medieval period were encountered.

The most striking aspect of the finds assemblage is the proportion of ceramic building material (CBM) recovered, primarily pieces of brick. Typologically, the earliest dated bricks are one or two pieces associated with F6 (T52) broadly dated as 15th to early 17th century. These might just overlap in date with the medieval pottery. However, they appear more likely to sit toward the beginning of the later (post-medieval and modern) activity here; pottery from the lower fill of the pit/quarry F9 (T13) suggests that this could begin around the late 17th to 18th century. Piece of red brick were recovered from a number of features, including a land drain F22 (T55) but the brick is primarily associated with two features, the pit/quarry F9 (T13) and kiln structure F10 (T58). These include unfrogged red bricks (c 18th-19th century), frogged red bricks (dated c late 19th-early 20th century) and a few pieces in pale fabrics which are probably Suffolk whites (produced c 16th-19th century but primarily 19th century). Several bricks have some sooting on the sides or ends, as does on piece of mortar, and a piece from an underfired (green) brick was recovered from the fill of F10.

While not proven, the post-medieval and modern finds could primarily result from brick-making on the area, possibly with a quarry pit (F9) for material and a brick-built kiln for firing (F10). In relation to F10 being identified as a kiln the most persuasive find is a brick sample from the base of the structure (51). Only a part of the brick could be recovered intact as it was crumbly and fractured from heat. This is from an unfrogged red brick 65 mm thick. The upper surface is scorched to a mauve-red, bruise-like colour which has penetrated the brick to a depth of about 5 mm and deeper down the sides of the network of cracks across the surface. The whole impression is of a brick that has been subjected to significant, probably repeated heating. In addition there is also a piece from underfired 'green' brick from this feature (50). The absence of any indication of brick-built structures (other than the proposed kiln) together with the relatively low quantity of pottery and other finds recovered, suggesting at best limited domestic activity, could be seen to support this. More generally the majority of the brick recovered shows no signs of having been mortared into a structure, the only bricks that clearly were are late 19th-early 20th century frogged bricks associated with grey cement mortar. It is noted that all of the 'white' bricks are located in or around F10 and might be connected with brick production here.

The nature of the kiln structure suggests a rectilinear shape and speculatively this suggest that it could represent a kiln type known as 'Suffolk kilns' that can be either surface built or partly set into the ground (Ryan 1999, 22).

In terms of dating the kiln the unfrogged brick from the floor, at 65 mm thick, can be broadly dated to the 18th-19th century, although at least one other similar piece from the fill (53) has been recorded at c 68 mm thickness suggesting an early 19th-century date. Late 19th-early 20th century frogged brick was recovered from the mid fill, although one piece of this is recorded as from the lower fill (53), but these can be seen to post-date the structure or might represent later repair. Elsewhere, the one or two early-dated glazed bricks recovered (F6) possibly come from a clamp firing, although their low representation suggests this might have taken place elsewhere. The pottery from F9 and other features reflects some concentration of activity here in the late 17th or 18th century and again (either following directly on or renewed) in the late 18th/19th-early 20th century. The majority of the brick pieces recovered are of 18th- or more likely early 19th-century date with some frogged pieces of certain late 19th-early 20th-century date.

#### **Metal-detecting survey**

*by Laura Pooley (weighed and measured by Z Eksen and H Furniss)*

The trenches were metal-detected before machining (L1) and the spoil heaps and features metal-detected after machining. All of the metalwork was identified from L1 and spoil heaps, none was recovered from features. There was a total of 41 pieces of ironwork (4384g) and one fragment of copper-alloy (6g). The ironwork consisted of 14 nails, 19 fragments of unidentified strip/sheet/bar/block and eight identifiable pieces including a large coil spring, bolts and a hook (see Table 1 for full details, all objects of iron unless otherwise stated). The piece of copper-alloy is probably part of a crotal bell used on horse-drawn vehicles. None need date to earlier than the late post-medieval/modern period and most, if not all, are probably of agricultural origin.

<b>Trench and finds no.</b>	<b>Description</b>
T1 (63) (spoil heap)	1) Broken nail-tip, round-shank, 3.5cm long, 1cm wide/thick, 2g. 2) Nail, incomplete (tip missing), round-shank, 8cm long, 1cm wide/thick, 24g. 3) Bar, crescent-shaped, thick rectangular-cross section at one end, flat and wider rectangular-cross section at other end (off-set 180°), 13cm, 3.4cm wide, 148g. 4) Bar, shaped roughly like a curving parallelogram, rectangular notch on one edge, 10cm long, 3cm wide, 0.5cm thick, 40g.
T2 (62) (spoil heap)	Headless nail, round-sectioned shank, 6.5cm long, 1cm wide/thick, 14g.
T3 (15) (spoil heap)	Small nail, headless, round-sectioned shank, bent 90°, 3cm long, 0.8cm wide/thick, 4g.
T4 (13) (spoil heap)	Flat sheet of iron, roughly-rectangular in shape, thicker along one long edge, thinner at other edge, 7.5cm long, 4.5cm wide, 0.5cm thick, 68g.
T4 (14) (spoil heap)	Flat sheet, roughly triangular in shape, 5cm long, 4cm wide, 1cm thick, 28g.
T5 (16) (spoil heap)	Head of a large bolt, head roughly square in shape, flat, only small part of rounded shank has survived. Head 5cm x 5cm by 0.8cm thick, surviving shank 1.8cm long, c 1.5cm diameter, 112g.
T5 (64)(surface find)	Crescent-shaped flat strip of iron, fragment only as appears broken on most edges, one surviving rivet may suggest it was part of a horseshoe, 9cm long, 3cm wide, 0.5cm thick, 38g.
T5 (65) (surface find)	Nail, 4cm long, 1.2cm wide/thick, 14g.
T6 (17) (spoil heap)	Flat, rectangular strip of iron, 9cm long, 1.5cm wide, 0.5cm thick, 30g.
T9 (18) (spoil heap)	Bar, square-cross section, 4.5cm long, 1.5cm wide/thick, 18g.
T9 (71) (spoil heap)	Heavy duty iron nail/bolt, straight-sided shaft, circular head (3cm dia) and shaft (2.4cm dia) with head not much wider than shaft, broken at end, 10cm long, 3cm dia, 248g.
T9 (73) (spoil heap)	Flat, rectangular sheet, 7cm long, 6cm wide, 0.5cm thick, 96g.
T11 (1) (surface find)	Large rod, circular in cross-section (2cm dia), shaped into a long S-shape with hook at one end, 26cm long, 2cm diameter, 746g.
T13 (22) (spoil heap)	Flat rectangular strip, 15.5cm long, 6cm wide, 1cm thick, 528g.
T13 (24) (spoil heap)	Small rectangular bar, broken at both ends, 3cm long, 1.8cm wide/thick, 8g.
T13 (66) (spoil heap)	Fragment of industrial piping, heavily rusted, 8cm long, 8cm wide, 1cm thick, 104g.
T15 (21) (spoil heap)	Flat, square strip, broken, semi-circular ridge runs down the centre of both sides which tapers to nothing towards the edge of the strip, 9cm long, 8.5cm wide, 4cm thick, 494g.
T16 (20) (spoil heap)	Fragment of curved copper alloy sheet, possibly from a small crotal bell, 4cm long, 3cm wide, 0.2cm thick, 6g.
T17 (70) (spoil heap)	Nail, complete, circular head, square/rectangular shaft, 7cm long, 1cm wide, 1cm thick, 16g.

T18 (19) (spoil heap)	Broken piece of sheet, slightly curved with small raised ridge down the middle, 9cm long, 5.5cm wide, 0.3cm thick, 90g.
T18 (67) (spoil heap)	Flat, rectangular bar, tapers to a point at one end, broken at other, 9cm long, 2cm wide, 1.5cm thick, 86g.
T19 (12) (spoil heap)	Fragment, roughly triangular in shape, broken on one edge, 5cm long, 5cm wide, 0.6cm thick, 38g.
T23 (2) (surface find)	Round headed nail, complete, round shaft, 4cm long, 1.5cm wide/thick, 10g.
T24 (68) (spoil heap)	1) Nail, almost complete (part of head missing), round-sectioned shaft slightly curving towards tip, 10cm long, 0.8cm wide, 0.5cm thick, 12g. 2) Fragment of sheet, 6cm long, 5cm wide, 0.5cm thick, 48g.
T27 (27) (spoil heap)	Thick, rectangular block, slightly tapering in width, 9.5cm long, 3-4cm wide, 2cm thick, 358g.
T33 (3) (surface find)	Small handle/fitting made from a circular bar curved inwards at each end, 6.5cm long, 1.5cm wide/thick, 16g.
T33 (4) (spoil heap)	Square-headed nail, broken circular shaft, 2cm long, 0.6cm wide/thick, 10g.
T33 (5) (spoil heap)	Round-headed nail, broken circular shaft, 1.6cm long, 1.5cm wide/thick, 8g.
T34 (28) (spoil heap)	Circular cap with short circular shaft, head – 6cm diameter, 0.5cm thick, shaft 2cm diameter and projects 1cm, 96g.
T36 (29) (spoil heap)	Flat irregular strip of metal, 6.5cm long, 1.5cm wide, 0.5cm thick, 16g.
T41 (10) (spoil heap)	Large fitting resembling a staple made from a long bar (rectangular cross-section) bent into a U-shape with two tapering, pointed ends, rod is 36.5cm long and 1cm wide/thick, staple is 18cm wide (max) by 16cm long (max), 174g
T43 (8) (spoil heap)	Small rectangular block, 3cm long, 1cm wide/thick, 16g.
T43 (9) (spoil heap)	Headless nail, square shaft, 4.5cm long, 0.5cm wide/thick, 8g.
T44 (6) (spoil heap)	Headless nail, square-shaft, 6cm long, 1cm wide/thick, 8g.
T48 (30) (spoil heap)	Nail, rectangular head, rectangular shaft, 5.5cm long, 1.4cm wide/thick, 10g.
T48 (31) (spoil heap)	Flat, rectangular piece, 5cm long, 4cm wide, 0.5cm thick, 44g.
T54 (11) (spoil heap)	Headless nail, 4cm long, 0.8cm wide/thick, 2g.
T56 (69) (spoil heap)	Big industrial spring coil made from a spiralled rod (round-cross section, 1cm in diameter) with one long projecting length of rod (37cm long), 6cm wide coil, 5cm thick deep, 554g.

**Table 3** Results of metal-detecting survey by trench number (all finds are of iron unless otherwise stated)

## 8 Environmental report

by Lisa Gray MSc MA ACIfA, Archaeobotanist

### Introduction – aims and objectives

Three samples were presented for assessment. They were taken from the probable kiln, a pit and a possible ditch dated as modern and post-medieval.

The aims of this assessment are to determine the significance and potential of the plant macro-remains in the samples, consider their use in providing information about diet, craft, medicine, crop-husbandry, feature function and environment.

### Sampling and processing methods

Samples were taken and processed by Colchester Archaeological Trust (110 litres of soil fully processed). All samples were processed using a Siraf-type flotation device. Flot was collected in a 300-micron mesh sieve then dried.



Once with the author the flots were scanned under a low powered stereo-microscope with a magnification range of 10 to 40x. The whole flots were examined. The abundance, diversity and state of preservation of eco- and artefacts in each sample were recorded. A magnet was passed across each flot to record the presence or absence of magnetised material or hammerscale.

Identifications were made using uncharred reference material (author's own and the Northern European Seed Reference Collection at the Institute of Archaeology, University College London) and reference manuals (such as Beijerinck 1947; Cappers *et al.* 2006; Charles 1984; Fuller 2007; Hillman 1976; Jacomet 2006). Nomenclature for plants is taken from Stace (Stace 2010). Latin names are given once and the common names used thereafter.

At this stage, to allow comparison between samples, numbers have also been estimated but where only a very low number of items are present they have been counted. Identifiable charred wood >4mm in diameter has been separated from charcoal flecks. Fragments this size are easier to break to reveal the cross-sections and diagnostic features necessary for identification and are less likely to be blown or unintentionally moved around the site (Asouti 2006, 31; Smart and Hoffman, 1988, 178-179). Charcoal flecks <4mm diameter have been quantified but not recommended for further analysis unless twigs or roundwood fragments larger than 2mmØ were present.

#### Results (Table 4)

##### *The plant remains*

Charcoal flecks and identifiable fragments were found in each sample with most in sample <3>. No other plant macro-remains were found.

Sample	Finds number	Feature number	Description	Period	Bulk volume processed (L)	Flot volume (ml)	Charred wood >4mmØ	Charred wood <4mmØ	Modern root/rhizomes	Terrestrial mollusca	Spherical hammerscale	Details – main and significant taxa
							a	a	a	a	a	
1	45	F10	?kiln/pit with brick base	modern	10	10	1	1	-	1	1	7 fragments of spherical hammerscale
2	44	F11/ F12	Pit/ditch	modern	40	5	1	1	-	-	-	-
3	48	F13	Pit	undated	30	300	3	3	1	-	-	-

**Table 4** Environmental results

Key: a = abundance [1 = occasional 1-10; 2 = moderate 11-100; and 3 = abundant >100]  
d = diversity [1 = low 1-4 taxa types; 2 = moderate 5-10; 3 = high]  
p = preservation [1 = poor (family level only); 2 = moderate (genus); 3 = good (species identification possible)]

##### *Fauna*

One terrestrial snail shell was found in sample <1>.

##### *Inorganic remains*

Sample <1> contained seven fragments of spherical hammerscale.

## Discussion

### **Biases in recovery, residuality, contamination**

Nothing with regards biases in recovery, residuality or contamination was highlighted for any of these samples. Evidence of bioturbation was scant.

### **Quality and type of preservation**

No waterlogged or mineralised plant remains were found.

Charred plant remains were present. Charring of plant macrofossils occurs when plant material is heated under ‘...reducing conditions...’ where oxygen is largely excluded (Boardman and Jones 1990, 2) leaving a carbon skeleton resistant to biological and chemical decay (English Heritage 2011, 17). These conditions can occur in a charcoal clamp, the centre of a bonfire or pit or in an oven or when a building burns down with the roof excluding the oxygen from the fire (Reynolds, 1979, 57).

No other plant macro-remains were found.

### **Significance and potential of the samples and recommendations for further work**

The charcoal in each sample may contain types suitable for radiocarbon dating.

## 9 Discussion

Archaeological evaluation uncovered twenty-eight features which originated from the post-medieval or modern periods, or else were undated: one pit/posthole, three linear features, one silt patch, three ditches, three pits, one probable kiln/pit, two linear features/pits, three land drains and three natural features as well as one possible feature/silt patch and one possible linear feature.

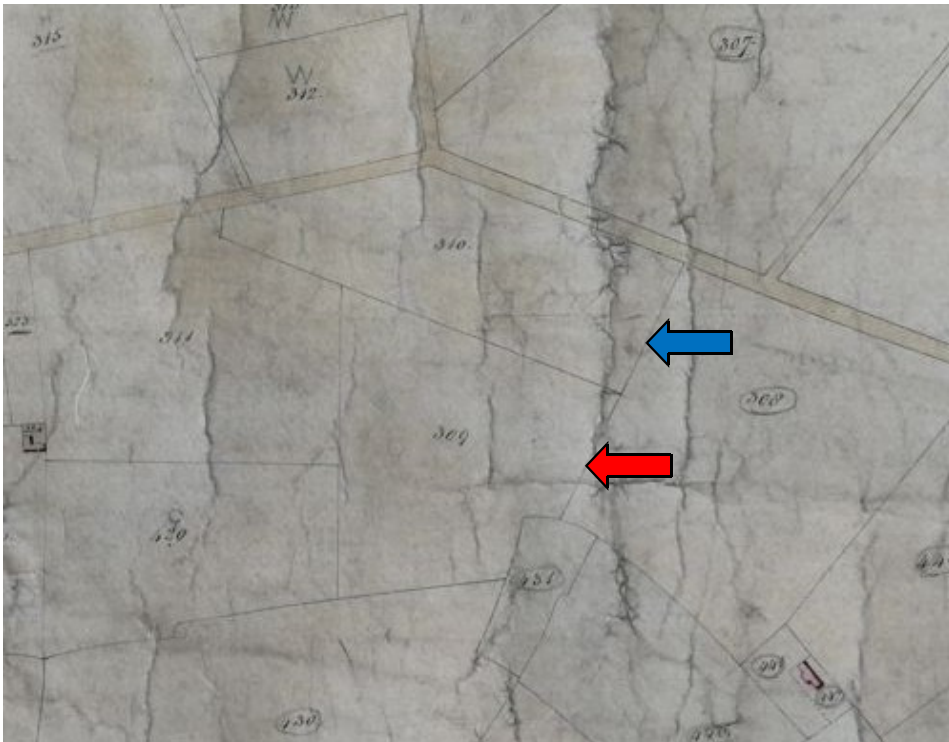

**Map 1** East Bergholt tithe map, 1837 (Suffolk Record Office, FB191/882). The field named 'Megs Well' is indicated by the blue arrow; the adjacent field 'Further Megs' is indicated by the red arrow.

Two of these features (F5 and F24) appear to represent the remains of the southern boundary ditch of a field named 'Megs Well', which is detailed in the 1837 tithe map of East Bergholt (see map above). An interesting clustering of features to the southeast of the site, in what would have been the southeastern corner of the field to the south, 'Further Megs', including the remains of the probable kiln, indicate that brick manufacture most likely took place here at some point during the modern period. The proximity of the site to a nearby field named 'Brickman's Downs', and another named 'Claypit Close', as well as to a 'Kiln Cottage', located some 1km north northwest of site, provides further evidence of the existence of this industry within the area during this period. Current archaeological evidence indicates that manufacture on this site was small in scale, and perhaps organised to meet domestic or local demand rather than representing a commercial venture. These findings therefore serve to augment our understanding of industry within this area in the 19th century, revealing the site to be one of mixed agricultural and industrial activity during this period.

A future research topic for the post-medieval period, as highlighted in the revised framework of the East of England, states that 'The development and diversity of rural industry (agricultural engineering, textiles, brick making) would benefit from further study...' (Medlycott 2011, p78). Further investigation of the brick kiln identified during this evaluation would certainly help to contribute to growing evidence for brick making not just in East Bergholt but the wider county. Recent locally excavated brick kilns such as those at Lodge Hill, Wormingford, at Stoke Road, Clare and Wash Pits Field, Euston would provide good examples for comparison with the kiln located here.

Excavations served to confirm the results of the magnetometer survey of the site undertaken by Britannia Archaeology Ltd in October 2016. Anomaly 1000 transpired to be a linear feature which was uncovered in T23 and T33. A large natural feature was uncovered in the area of Anomaly 1001, in T27, T37, T36, T38 and T39, though it did not correspond exactly with the results of the surveying. A land drain was uncovered in the area of Anomaly 1002, across T25 and T26. Anomalies 1004, 1005 and 1006 indicated the grouping of features in the southeastern corner of the site, located across T58, T59 and 60. The following features were not detected by this survey: pit/posthole F1, silt patch F4, ditch F5, possible feature F6, pit F9, pit F13, natural feature F17, ditch F19, ditch F20, land drain F22, pit F23, linear feature F24, pit F25, pit/linear F26 and linear/silt patch F27.

## 10 Acknowledgements

CAT is grateful to Stephen Williams of Hills Residential for commissioning and funding the project. The project was managed by C Lister, fieldwork was carried out by N Rayner with H Furniss, J Roberts, A Tuffey, Z Eksen and G Morgan. Figures are by J Roberts and S Carter. The project was monitored by Rachael Abraham for Suffolk County Council Archaeological Services.

## 11 References

Note: all CAT reports, except for DBAs, are available online in .pdf format at <http://cat.essex.ac.uk>

- |                           |      |  |
|---------------------------|------|--|
| Asouti, E                 | 2006 | 'Factors affecting the formation of an archaeological wood charcoal assemblage.' Retrieved on 13th February 2015 from World Wide Web:<br><a href="http://pcwww.liv.ac.uk/~easouti/methodology_application.htm">http://pcwww.liv.ac.uk/~easouti/methodology_application.htm</a> |
| Beijerinck, W             | 1947 | <i>Zadenatlas der Nederlandsche Flora</i> . Veenman and Zonen Wageningen.  |
| Britannia Archaeology Ltd | 2016 | <i>Land east of the Constable Medical Centre, Heath Road, East Bergholt: Detailed Magnetometer Survey. Report Number 1145: October 2016</i>  |
| Brown, N and              | 2000 | <i>Research and Archaeology: a frame work for the Eastern Counties</i>   |

Glazenbrook, J.		<i>2 Research agenda and strategy</i> , East Anglian Archaeological, occasional papers 8 (EAA 8)
Cappers, R J T, Bekker, R M & Jans, J E A CAR 7	2006 1999	<i>Digital Zadenatlas Van Nederlands - Digital Seeds Atlas of the Netherlands</i> . Groningen Archaeological Studies Volume 4. Groningen: Barkhius Publishing Groningen. <i>Post-Roman pottery from excavations in Colchester, 1971-85</i> , Colchester Archaeological Report 7, by John Cotter
CAT	2014	<i>Health &amp; Safety Policy</i>
CAT	2017	<i>Written Scheme of Investigation (WSI) for an archaeological evaluation on land east of Constable Country Medical Centre, Heath Road, East Bergholt, Suffolk, CO7 6RT</i>
CAT Report 966	2016	<i>A desk-based assessment of the archaeological remains on and around land017 at Heath Road, East Bergholt.</i>
Charles, M	1984	'Introductory remarks on the cereals.' <i>Bulletin on Sumerian Agriculture</i> 1, 17-31.
CifA	2008a	<i>Standard and Guidance for an archaeological evaluation</i>
CifA	2008b	<i>Standard and guidance for the collection, documentation, conservation and research of archaeological materials</i>
DCLG	2012	<i>National Planning Policy Framework</i>
Gurney, D	2003	<i>Standards for field archaeology in the East of England</i> . East Anglian Archaeology Occasional Papers 14 (EAA 14).
English Heritage	2006	<i>Management of Research Projects in the Historic Environment (MoRPHE)</i>
English Heritage	2011	<i>Environmental Archaeology: A Guide to the Theory and Practice of Methods for Sampling and Recovery to Post-Excavation</i> . Swindon: English Heritage Publications.
Fuller, D	2007	'Cereal Chaff and Wheat Evolution' Retrieved on 12 <sup>th</sup> February 2010 from World Wide Web: <a href="http://www.homepages.ucl.ac.uk/~tcrndfu/archaeobotany.htm">http://www.homepages.ucl.ac.uk/~tcrndfu/archaeobotany.htm</a>
Hillman, G C	1976	'Criteria useful in identifying charred Wheat and Rye Grains.' Unpublished versions of notes likely to have entered publication in some form and given to the author by Gordon Hillman during her MSc in 1995-1996.
Jacomet, S	2006	<i>Identification of cereal remains from archaeological sites – second edition</i> . Basel: Basel University Archaeobotany Lab IPAS.
Medlycott, M	2011	<i>Research and archaeology revisited: A revised framework for the East of England</i> . East Anglian Archaeology Occasional Papers 24 (EAA 24)
Reynolds, P	1979	<i>The Iron Age Farm: The Butser Experiment</i> London: British Museum Press.
Ryan, P	1996	<i>Brick in Essex, from the conquest to the Reformation</i>
Ryan, P	1999	<i>Brick in Essex, the clay working craftsmen and gazetteer of sites</i>
SCC	2008	<i>The Suffolk Historic Landscape Characterisation Map, version 3</i>
SCCAS	2017a	<i>Requirements for a Trenched Archaeological Evaluation (version 1.3)</i>
SCCAS	2017b	<i>Archaeological Archives in Suffolk: Guidelines for preparation and deposition</i>
Smart ,T & Hoffman, E S	1988	'Environmental Interpretation of Archaeological Charcoal.' In Hastorf C.A. and Popper V.S. <i>Current Palaeobotany</i> Chicago and London. University of Chicago Press.
Stace, C	2010	<i>New Flora of the British Isles 3rd Edition</i> . Cambridge University Press Cambridge.

## 12 Abbreviations and glossary

CAT	Colchester Archaeological Trust
CBM	ceramic building material, ie brick/tile
CifA	Chartered Institute for Archaeologists
context	specific location of finds on an archaeological site
feature (F)	an identifiable thing like a pit, a wall, a drain, can contain 'contexts'
layer (L)	distinct or distinguishable deposit (layer) of material
medieval	period from AD 1066 to c AD 1500
modern	period from c AD 1800 to the present
natural	geological deposit undisturbed by human activity

Neolithic	period from c 4000 – 2500 BC
NGR	National Grid Reference
OASIS	Online Access to the Index of Archaeological Investigations, <a href="http://oasis.ac.uk/pages/wiki/Main">http://oasis.ac.uk/pages/wiki/Main</a>
peg-tile	rectangular thin tile with peg-hole(s) used mainly for roofing, first appeared c AD1200 and continued in use to present day, but commonly post-medieval to modern
post-medieval residual	from c AD 1500 to c 1800 something out of its original context, eg a Roman coin in a modern pit
Roman	the period from AD 43 to c AD 410
SCC	Suffolk County Council
SCCAS	Suffolk County Council Archaeological Services
SCHER	Suffolk County Historic Environment Record
section	(abbreviation sx or Sx) vertical slice through feature/s or layer/s
u/s	unstratified, ie without a well-defined context
wsi	written scheme of investigation

### 13 Contents of archive

**Finds:** none retained

**Paper and digital record**

One A4 document wallet containing:

The report (CAT Report 1164)

SCCAS evaluation brief, CAT written scheme of investigation

Original site record (feature and layer sheets, trench record sheet, finds record)

Site digital photographic log, site photographic record on CD

Sundries (attendance register, benchmark data, risk assessment).

### 14 Archive deposition

The paper archive and finds are currently held by CAT at Roman Circus House, Roman Circus Walk, Colchester, Essex, but will be permanently deposited with SCCAS under Parish Number EBG 060.

**Distribution list:**

Stephen Williams, Hills Residential  
Rachael Abraham, SCCAS  
Suffolk County Historic Environment Record



**Colchester Archaeological Trust**

Roman Circus House,  
Roman Circus Walk,  
Colchester,  
Essex, CO2 7GZ

tel.: 01206 501785

email: [lp@catuk.org](mailto:lp@catuk.org)

checked by: Philip Crummy  
date: 6.10.2017



## Appendix 1 Context list

Trench no.	Context Number	Finds Number	Feature / layer type	Description	Date
	L1		Topsoil	Loose, dry, dark brown silty-loam with occasional chalk and CBM fleck inclusions and occasional stone piece inclusions	Modern
	L2		Natural	Firm, moist, medium mottled orange/grey/brown sandy-clay/sand with chalk fleck inclusions and stone and chalk piece inclusions	Post-glacial
	L3		Subsoil	Firm, moist, medium grey/brown silty-clay	Undatable
	L4		Natural (subsoil)	Firm, dark orange/brown silty-clay	Undatable
T33	F1	-	Pit / posthole	Firm, dry, dark grey/brown silty-clay with CBM fleck inclusions and occasional stone piece inclusions	Undatable
T23	F2	23	?Ditch	Firm, dry, medium grey/brown silty-clay	?Post-medieval
T33	F3	25	Ditch	Firm, dry, medium grey silt	Modern
T30	F4		Silt patch	Hard, light grey silt	Undatable
T31	F5	32	Ditch	Firm, dry, light grey sandy-silt	?Post-medieval
T52	F6	33	Possible feature – ditch or spread	Very firm, dry, light grey/brown silty-clay with CBM fleck inclusions	Post-medieval
T60	F7	34	Ditch	Friable, dry, medium brown silty-clay	Modern
T60	F8	35	Possible ditch	Soft, moist, dark grey/brown silty-clay with charcoal and brick fleck inclusions	Modern
T13	F9	36, 37, 59, 74	Pit	Firm, dry, medium grey/brown clayey-silt	Modern
T58	F10	38, 39, 40, 45, 50, 51, 52, 53	?Kiln	Firm medium orange silty-clay with charcoal, daub, brick and tile fleck inclusions and stone piece inclusions	Modern
T59	F11	41, 43, 44	Ditch or pit	Firm, dry, dark grey/brown sandy-silt with brick, tile and chalk fleck inclusions and stone piece inclusions	Post-medieval / modern
T59	F12	42, 44	Ditch or pit	Hard, dry, medium yellow/grey/brown sandy-silty-clayey-loam with charcoal, brick and tile fleck inclusions and occasional stone piece inclusions	Modern
T5	F13	47, 48, 58	Pit	Firm, dry, medium grey silt with charcoal fleck inclusions and occasional stone and charcoal piece inclusions	?undated
T25	F14	49	Land drain	Firm, dry, medium grey/brown sandy-silty-loam	Post-medieval / modern
T26	F15	-	Land drain	Firm, dry, medium grey/brown sandy-silty-loam	Post-medieval / modern
T38	F16	-	Natural feature	Hard, dry, light grey/brown silty-clay with stone piece inclusions	Undatable
T12	F17	-	Natural feature	Very firm, dry, light yellow silt with common small and medium stone inclusions	Undatable

T36	F18	-	Ditch	Friable, medium grey silty-clay	Undatable
T16	F19	-	Ditch	Loose, soft, dry, medium grey/brown sandy-silt with occasional stone piece inclusions	Undatable
T16	F20	-	Ditch	Loose, soft, dry, medium, grey/brown sandy-silt with occasional stone inclusions	Undatable
T37	F21	-	Natural feature	Firm, dry, medium grey/brown sandy-silt	Undatable
T55	F22	55	Land drain	Soft, moist, medium grey/brown silt with occasional charcoal and CBM fleck inclusions and common medium stone piece inclusions	Modern
T7	F23	-	Pit	Soft, dry, medium grey silty-sand with frequent stone piece inclusions	Undatable
T9	F24	-	Ditch	Soft, moist, medium brown silty-clay	Undatable
T35	F25	-	Pit	Soft, moist, medium grey silty-sand with charcoal fleck inclusions and stone piece inclusions	?Modern
T49	F26	-	Pit / ditch	Hard, dry, medium grey/brown sandy-silt with occasional brick fleck inclusions and occasional stone piece inclusions	Post-medieval
T13	F27	-	?Ditch ?silt patch	Soft, medium grey/brown moist, silty-sand	Undatable
T27	F28	-	Natural feature	Firm, dry, medium orange/grey/brown silty-sand with frequent stone piece inclusions	Undatable

## Appendix 2 Finds list

Trench	Context	Context type	Find no.	Type/ description	Finds spot date
T5	F13	Pit	47	<b>Burnt stone:</b> 3 heat altered (discoloured) flints	Not closely-dated
T5	F13	Pit	58	<b>Burnt stone:</b> 1 heat altered (discoloured) flint <b>Charcoal:</b> Quantity of small pieces of charcoal	Not closely-dated
T10	L1	Topsoil	7	<b>Pottery: Modern</b> Fabric 45M Glazed foul water pipe sherd (42g) (19th- to early 20th-century)	Modern
T13	F9	Pit/quarry? (midfill)	36	<b>Clay tobacco pipe:</b> small stem piece, pipe bore 2mm <b>CBM:</b> Peg-tile, 2 pieces one with fine (?machine milled) fabric probably c late 19th- to early 20th-century	Post-medieval
T13	F9	Pit/quarry? (lower fill)	59	<b>Post-medieval/modern pottery:</b> Fabric 40 (18, 406g, EVE 0.30) inc sherds from large dishes/pancheons, bowl and large jar (c 17th- to 18th-century); Fabric 40B (3 sherds, 46g); Fabric 45 (2 sherds, 24g) (c 16th- to 19th-century); Fabric 46A (4 sherds, 18g) including speckled fabric handled bowl/mug (probably late 17th- to 18th-century); Fabric 48D (2 sherds, 4g) (mid 18th- to 19th-century); Fabric 50 (1 sherd, 14g) (late 17th- to 18th-century); Fabric 51A (1 sherd, 12g) (19th- to early 20th-century) <b>Glass: (vessel)</b> 5 pieces/sherds, all green bottle glass, several vessels represented, includes base from a bottle with flaking (oxidising) surfaces (c late 17th or 18th- to early 19th-century) and another sherd also from an indented bottle base; <b>(window)</b> 2 pieces, very small flat thin sherds with flaking (oxidising) surfaces probably window glass <b>CBM:</b> - End of a red brick 108 x 58mm ( <b>small brick</b> ) - 2 pieces from bricks (orange fabric) - piece from a red brick (slightly abraded) <b>blackened on surviving surfaces</b> - Piece from a <b>tile/thin floor brick?</b> 15 mm thick, yellow-buff fabric - Piece from a <b>pantile</b> - Piece from a <b>ceramic drain pipe</b> smooth surfaces, fine fabric (late 19th- to early 20th-century) - Peg-tile, 10 pieces, one with square peg hole - Peg-tile, 4 pieces (medium-large) includes one grey-brown piece ( <b>misfired?</b> ) - Piece of brick (red-brown) - Brick piece (greenish-grey/buff) <b>Iron:</b> All corroded, nail or possibly a large rivet (75mm), curving piece (?ring) and a piece of iron plate (all probably post-medieval/modern – almost certainly agricultural or industrial derived objects/fittings) <b>Animal bone:</b> Piece from a medium size mammal long bone (badly degraded surfaces) and single sheep tooth	Late 18th- to 19th-century, probably early 19th-century (most pottery c 17th- to 18th-century)
T13	F9	Pit/quarry? (lower fill)	37, 74	<b>Copper-alloy:</b> Two near identical buttons (SF2 and SF3) both with round, convex disc face, one a plain disc missing the shank, the other retaining the round loop shank (face dia. 20mm) and with band of small internal lettering <b>JGILT / ALL OVER</b> (c late 18th- or 19th- to early 20th-century)	Modern (late 18th- or 19th- to early 20th-century)
T19	L1	Topsoil	31	<b>Worked flint:</b> small, squat secondary flake (some cortex) flake removal scars on dorsal face, plunge fracture ventral face (prehistoric) – failed piece intended as a longer flake/blade - unusually is retouched along edge proximal edge but this is achieved as the odd nature of the flake makes the	Prehistoric <b>Residual</b>

Trench	Context	Context type	Find no.	Type/ description	Finds spot date
				shape of this more like a normal flake edge than would be usual	
T23	F2	Linear?	23	<b>CBM:</b> - Piece of red brick - Peg-tile, 8 small-medium size pieces	Probably post-medieval
T25	F14	Drain	49	<b>CBM:</b> - large part of a red brick (reddish orange) 110 x 65mm - Part of a thick ?hearth or kiln brick/tile, relatively fine sand reddish-orange fabric with blackened surface, 45mm thick (min size > 140 x >125mm) (1406g)	Post-medieval/modern
T26	L1	Topsoil	57	<b>Modern pottery:</b> sherd, Fabric 51A (70g) (19th- to early 20th-century)	Modern
T26	L1	Topsoil	61	<b>Worked flint:</b> Tertiary flake with blade/blade-like earlier removals on dorsal face, earlier flake scars across striking platform – Late prehistoric, probably Early Neolithic	Late prehistoric <b>Residual</b>
T27	L1	Topsoil	61	<b>Stone:</b> Natural flint shatter piece (discarded)	Modern
T31	F5	Ditch	32	<b>CBM:</b> - piece from a red brick	Probably post-medieval
T33	F3	Linear	25	<b>Modern pottery:</b> Fabric 48D single small sherd (2g) (late 18th- or 19th- to early 20th-century) <b>Clay tobacco pipe:</b> small part of stem and bowl, spur foot (damaged) with small fragment of one initial of pipe maker, diagonal moulded lines on stem, bowl mould decorated but only a small part remains, probably 19th-century <b>CBM:</b> - small piece of peg-tile - small piece of nondescript orange tile/brick	Modern (19th-century?)
T49	F26	Pit	56	<b>Post-medieval pottery:</b> sherd, Fabric 40 (32g) base edge of pot, glazed inside and out (not on base underside) (17th- to 18th- or early 19th-century)	Post-medieval (17th or 18th to early 19th-century)
T50	L1	Topsoil	46	<b>Medieval pottery:</b> (Fabric 20) (6g) abraded sandy sherd from base edge of pot (c 13th- or 14th- to 15th-century)	Medieval 13th- to 14th-century <b>Residual</b>
T52	F6	Linear or spread?	33	<b>CBM:</b> - Piece of brick (brownish-red) 45mm thick, with <b>grey glaze on surface</b> - Piece of red brick, 50-55mm thick, grey end to brick <b>with near glaze effect</b> - Peg-tile, 1 small piece - Miscellaneous small brick fragments <b>Coal:</b> Piece of laminar black material probably poor quality coal	Post-medieval (c 15th-to early 17th-century?)
T55	L1 (F22?)	Land drain	54	<b>Post-medieval/modern pottery:</b> Stoneware sherd, Fabric 45/45M (24g) (18th- to 19th-or early 20th-century)	Modern (late 18th- to 19th- or early 20th-century)
T55	F22	Land drain	55	<b>CBM:</b> brick pieces probably flooring bricks - Piece of red brick, not frogged, <b>burnt/sooted</b> on one side face 105 x 55mm - End of brick, <b>thin brick</b> 95 x 40mm, dull red fabric, sanded base, upper <b>surface worn/abraded</b> - End of brick, brownish-red, 110 x 45mm, sanded base with <b>worn upper surface</b>	Modern (c 19th-century)

Trench	Context	Context type	Find no.	Type/ description	Finds spot date
				- End of brick 110 x 40mm, cream-buff fabric - Peg-tiles 2 piece (small-medium)	
T58	F10	Kiln?	38	<b>CBM:</b> - Complete red brick (brownish-orange) chipped at one end, also some rubbing/wear producing rounded edge at one end 230 x 115 x 68mm (weight 3308g) - End of a red brick (brownish-orange), 110 x 65mm, central rectangular <b>frog</b> (Type 1) - End of a red brick (brownish-orange), 110 x 65mm, central rectangular <b>frog</b> (Type 1)	Modern (mid 19th- to early 20th-century)
T58	F10	Kiln?	39	<b>CBM:</b> - End of a red brick, rectangular, 110 x 65mm <b>frog</b> (Type 1) - 2 pieces of mortar, grey, cement based with impressions of Type 1 frogs	Modern (mid 19th- to early 20th-century)
T58	F10	Kiln?	40	<b>Post-medieval/modern pottery:</b> Stoneware sherd, Fabric 45/45M (12g) (18th- to 19th- or early 20th-century) <b>Glass:</b> Two small pieces of green bottle glass (probably 19th- to early 20th-century) <b>Clay tobacco pipe:</b> two small stem pieces, pipe bore 1.5 mm/2 mm <b>CBM:</b> - small piece from a pale red brick with white silty inclusions ( <b>Suffolk white</b> ) <b>Animal bone:</b> undistinguished small piece from small-medium size mammal	Post-medieval (late 18th- or 19th- to early 20th-century)
T58	F10	Kiln?	50	<b>CBM:</b> - Corner from a red brick, soft fabric, underfired/hardly fired at all ( <b>green brick?</b> ), 65mm thick (548g)	(Post-medieval)
T58	F10	Kiln?	51	<b>CBM:</b> - Piece from a red brick, 65mm thick	Modern (c 19th-century)
T58	F10	Kiln?	52	<b>CBM:</b> End of brick 105 x 30mm, pale greenish-grey/buff fabric, <b>worn surface</b>	
T58	F10	Kiln?	53	<b>CBM:</b> - End of a red brick, traces of lime mortar on surface 105 x 65mm - Red brick piece 65mm thick - Red brick piece 65mm thick, one end appears burnt/scorched - Part of brick with <b>frog</b> (Type 1) - lump of lime mortar, flat surfaces from contact with bricks (brick impressions) with pieces/fragments of brick or hard clay daub in fabric; mortar possibly sooted on one of the flat surfaces - End of a brick, pale orange-buff fabric (Suffolk white?) 110 x 66mm - Piece of brick, faintly greenish pinky white fabric (Suffolk white?) 65-67mm thick - Piece of brick (faintly greenish pinky white fabric (Suffolk white?), c 68mm thick - Piece from a red brick 115 x 65mm - Piece from a red brick 68mm thick - Piece from a red brick with lime mortar ( <b>used brick</b> ) - piece of peg-tile (medium size piece)	Modern (mid 19th- to early 20th-century)
T59	F11	Linear or large pit	41	<b>Post-medieval pottery:</b> (2 sherds, 18g) Fabric 40, small sherds (c 17th- or 18th- to early 19th-century) <b>Clay tobacco pipe:</b> 1 stem piece, pipe bore c 2mm <b>Coal:</b> 2 small pieces (probably post-medieval/modern) <b>CBM:</b>	Post-medieval (c late 17th- or 18th- to early 19th-century)

Trench	Context	Context type	Find no.	Type/ description	Finds spot date
				<ul style="list-style-type: none"> <li>- 2 pieces of red brick</li> <li>- 4 miscellaneous small brick pieces/fragments</li> <li>- 44 peg-tile and other miscellaneous small tile pieces (all quite broken-up)</li> <li>- Abraded brick/tile piece with small area of green glaze</li> <li>- <b>Horseshoe field drain</b>, 5 pieces, made with <b>small foot on base edges</b></li> </ul> <b>Iron:</b> Nail shaft piece (square shaft) 60mm long, part of head(?)	
T59	F11	Linear or large pit	43	<b>CBM:</b> <ul style="list-style-type: none"> <li>- Piece from a red brick</li> <li>- Peg-tile, 4 pieces (small, broken-up pieces)</li> <li>- Tile pieces, gently curving, 18mm thick, rough, fine sanded, convex exterior?, soot blackened (concave) interior?</li> </ul>	Post-medieval/modern
T59	F12	Linear/pit	42	<b>Medieval pottery:</b> Greyware sherd, Fabric 20 (4g) quite abraded, Roman or medieval, probably medieval; <b>Modern pottery:</b> sherd Fabric 48D (2 g) glazed earthenware handle with hand painted blue stripe (c late 18th- to 19th-century) <b>CBM:</b> <ul style="list-style-type: none"> <li>- piece from a land-drain pipe</li> <li>- piece of peg-tile</li> </ul>	Modern (c late 18th- to 19th-century)
T60	F7	ditch	34	<b>Post-medieval/modern pottery:</b> sherd Fabric 40 (42g) very abraded (late 16th- or 17th- to late 18th- or early 19th-century); 2 sherds (38 g) Fabric 48E, Fabric 48D (late 18th- or 19th- to early 20th-century) <b>Glass:</b> small sherd of green bottle glass (c 18th- or 19th-century) <b>Stone:</b> (natural) natural flint flake (primary with cortex) discarded <b>CBM:</b> <ul style="list-style-type: none"> <li>- small piece from a brick/thick tile</li> <li>- small piece of peg-tile</li> </ul>	Modern (late 18th- to 19th- or early 20th-century)
T60	F8	Linear?	35	<b>Post-medieval/modern pottery:</b> Fabric 40 (1 sherd, 10g) (late 16th- or 17th- to late 18th- or early 19th-century); 2 sherds (10 g) Fabric 45/45M and Fabric 48D (18th- to 19th-century) <b>CBM:</b> <ul style="list-style-type: none"> <li>- Large piece from a brick pale pink/red fabric with buff surfaces and while/buff silty inclusions, 55mm thick, slightly abraded (<b>Suffolk white</b>) (<i>note - Suffolk whites made c 16th- to 19th-century but main production/typically 19th-century, thickness here might suggest 17th- to 18th-century</i>)</li> <li>- 3 miscellaneous small red/orange brick pieces/fragments</li> <li>- 2 small miscellaneous pieces of tile/peg-tile</li> </ul> <b>Shell:</b> small piece of oyster shell, abraded	Modern (18th- to 19th-century)
T72	US	Trench spoil	72 (SF1)	<b>Hone: (SF1)</b> rectangular piece from a stone hone (14 g) broken at ends (80mm long x 30/32mm wide x 20mm thick) reddish-brown sandstone/quartzite.	Not closely-dated



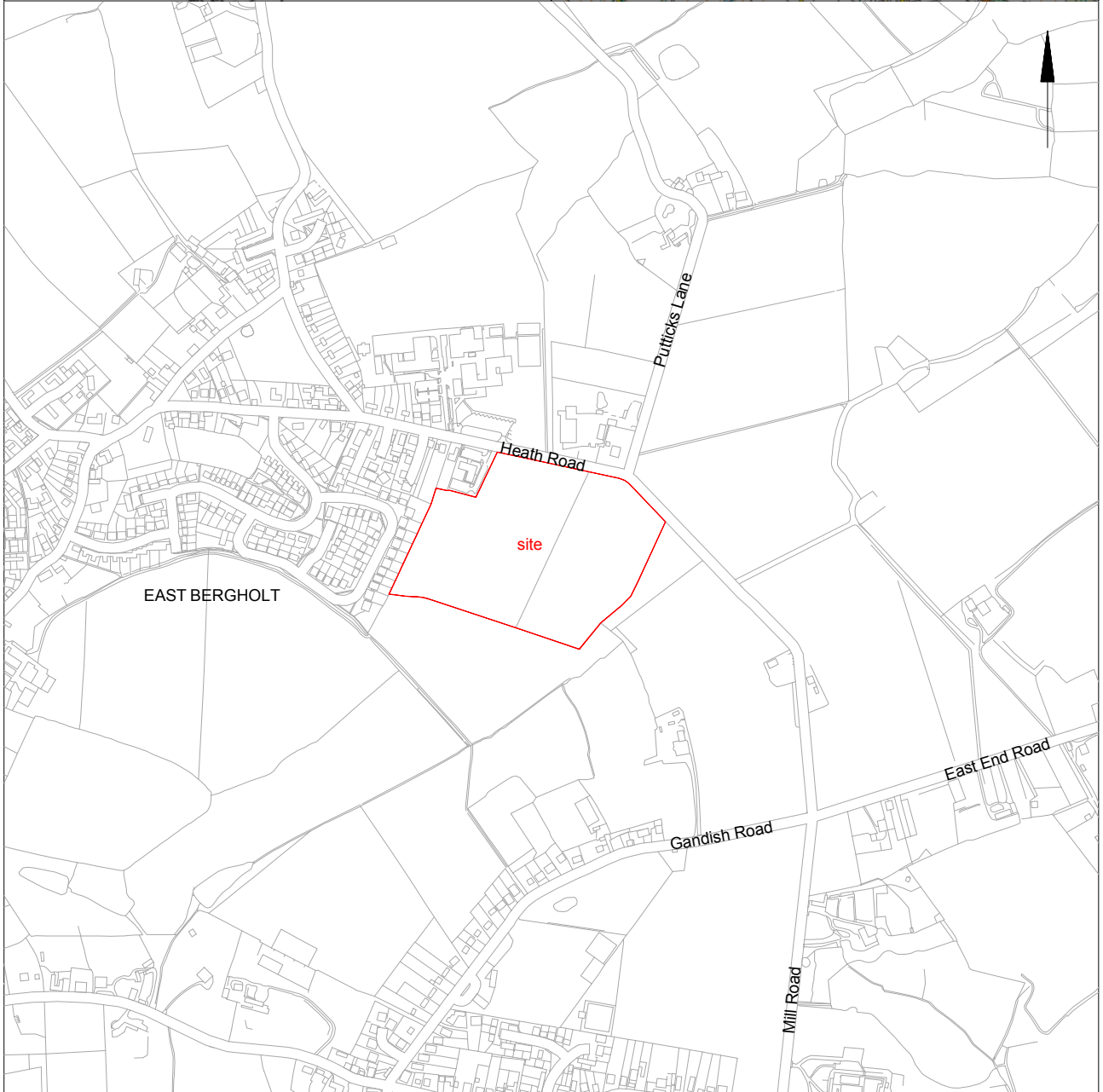
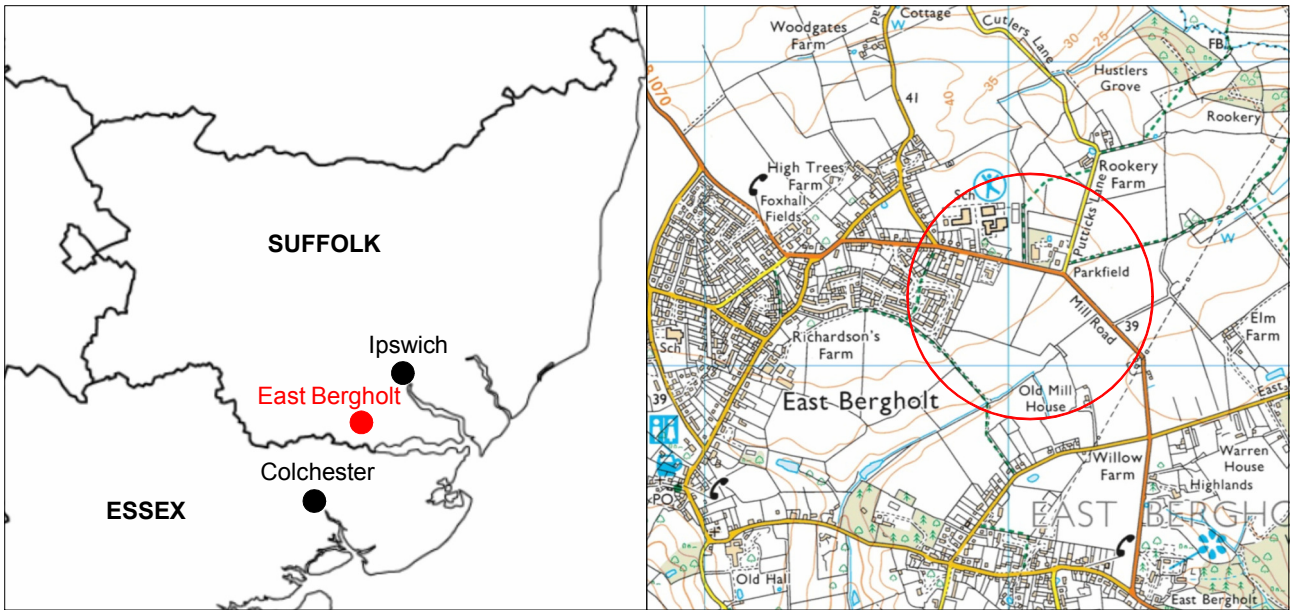

© Crown copyright. All rights reserved. Licence number 100039294.

Fig 1 Site location.





Fig 2 HER data (green) and listed buildings (blue) in relation to the development site (marked red).

© Crown copyright. All rights reserved. Licence number 100039294.  
Imagery ©2017 Google, Getmapping plc, Infoterra Ltd & Bluesky, Map data ©2017 Google.







Fig 3 Evaluation results. Geophysical anomalies marked in blue (numbers as Britannia Archaeology Ltd Report Number 1145).

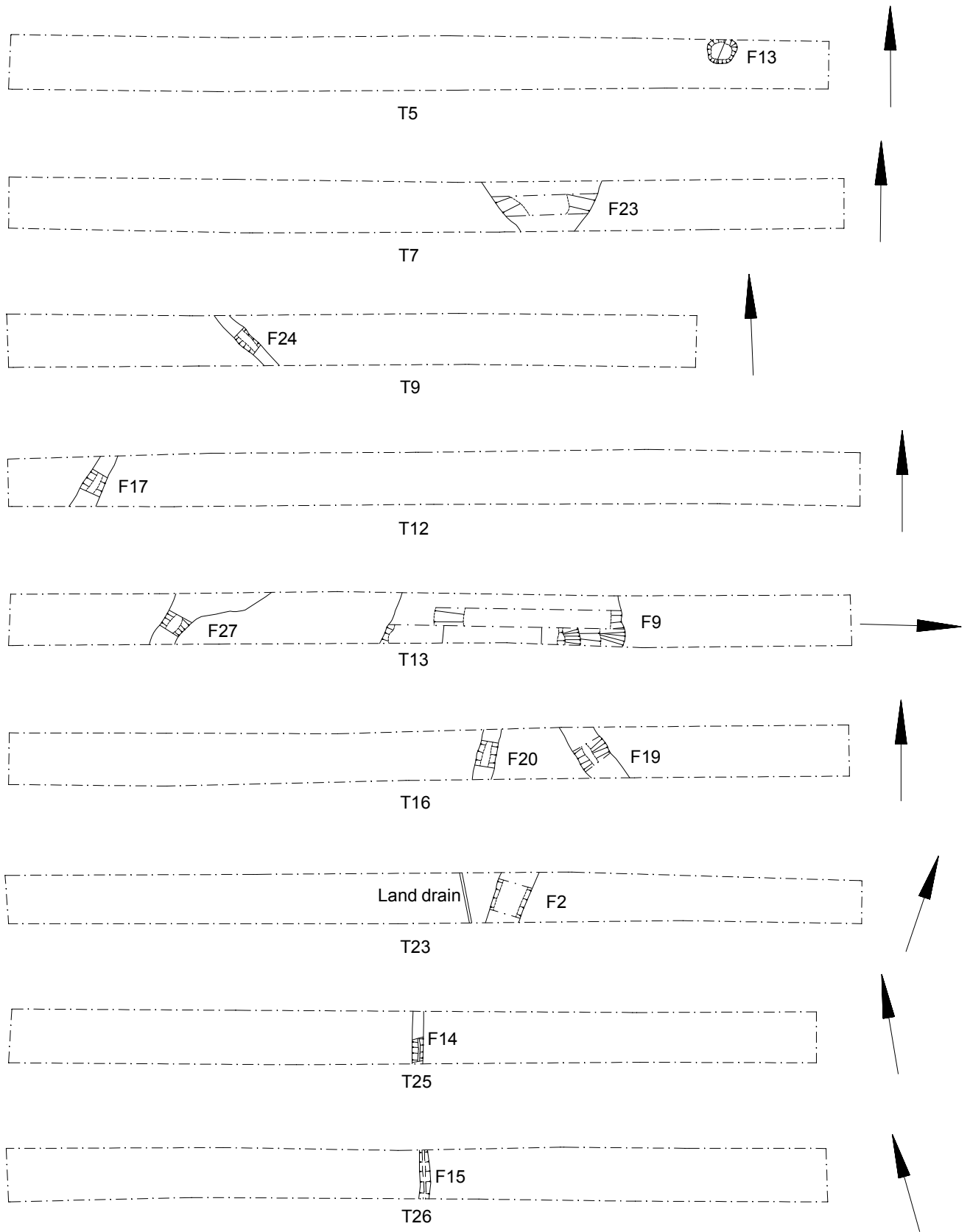

Fig 4 Detailed trench plans



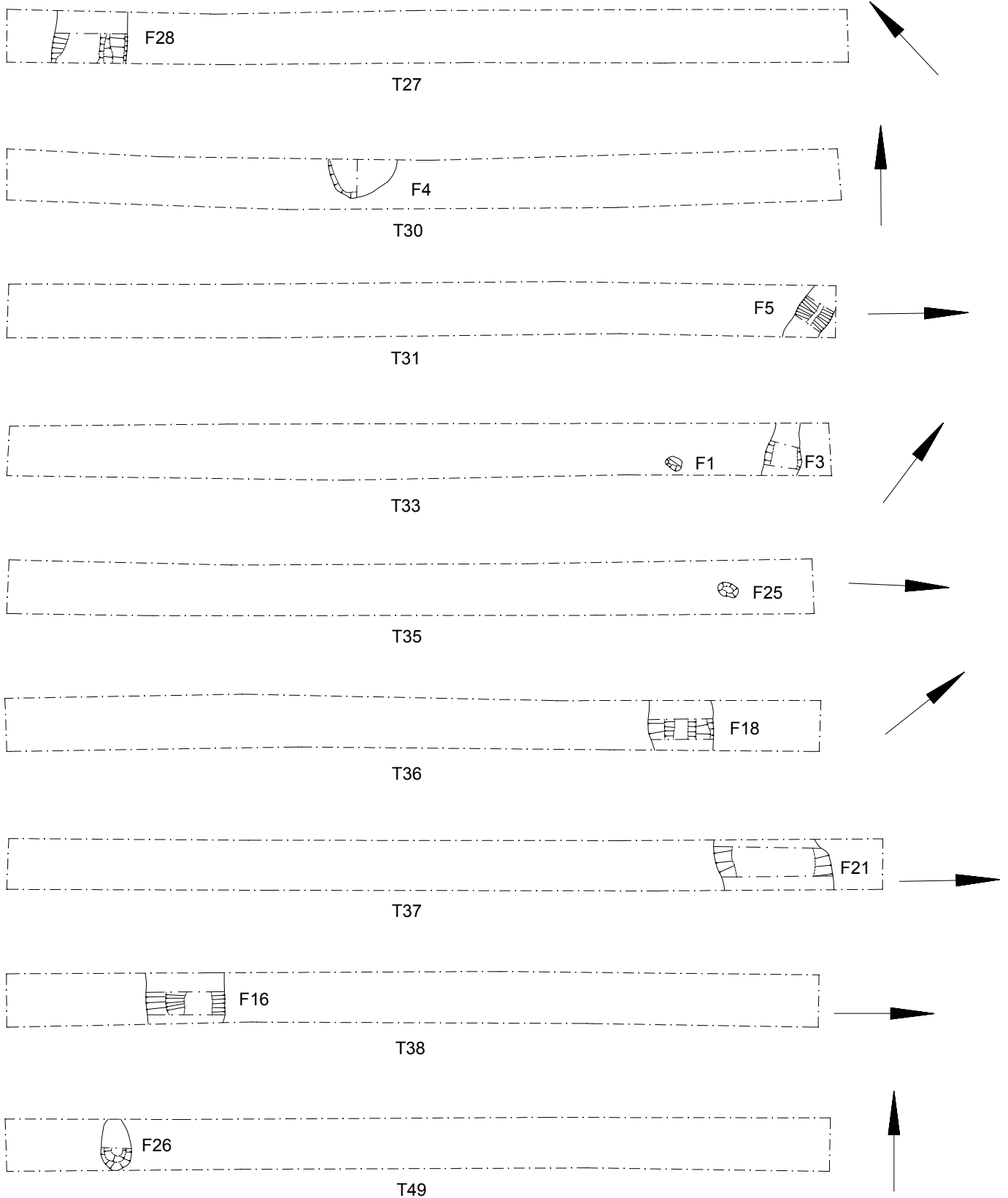

Fig 5 Detailed trench plans



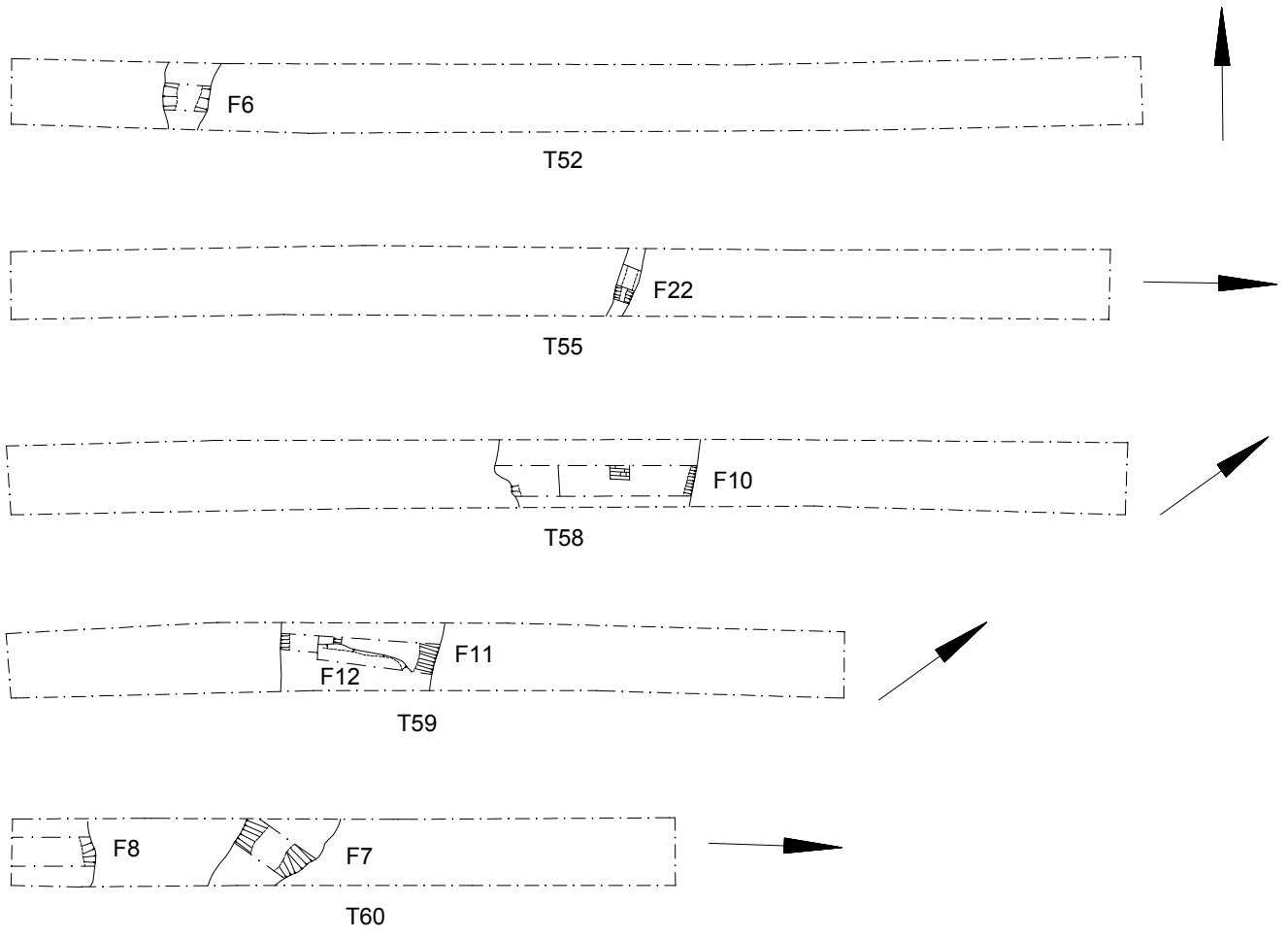
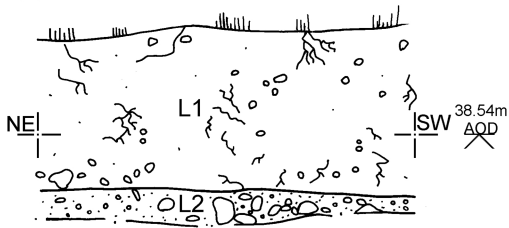

Fig 6 Detailed trench plans



T33



T57

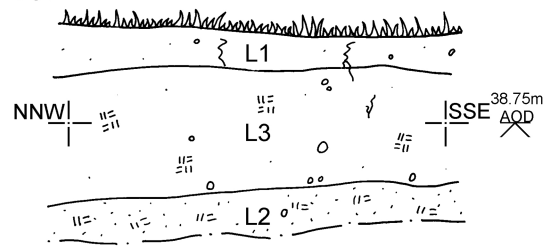

T59

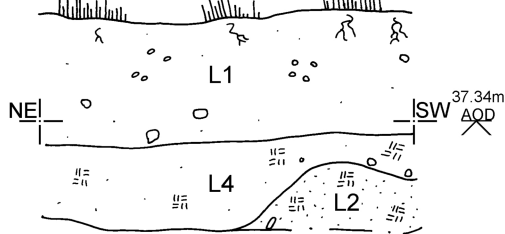

F6

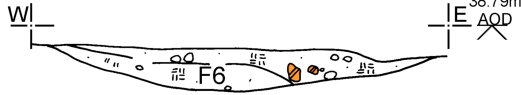

F7

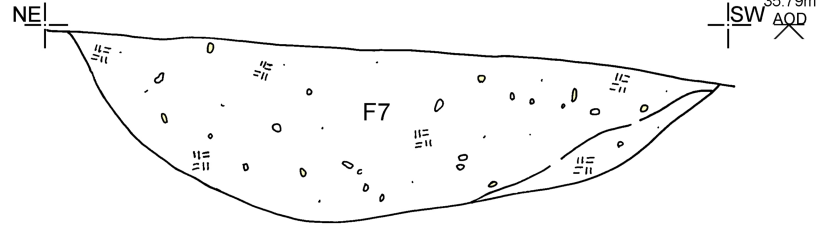

F13

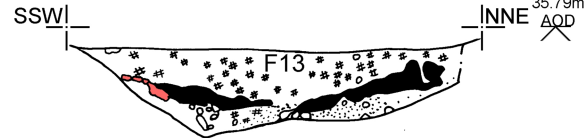

- sand
- small stones
- large stones
- √ roots
- || clay
- ## charcoal
- thick charcoal
- " " iron pan
- fired clay
- X X mortar flecks
- X X mortar fragments
- ▨ post-Roman brick
- ~ section join



Fig 7 Feature and representative sections



F9

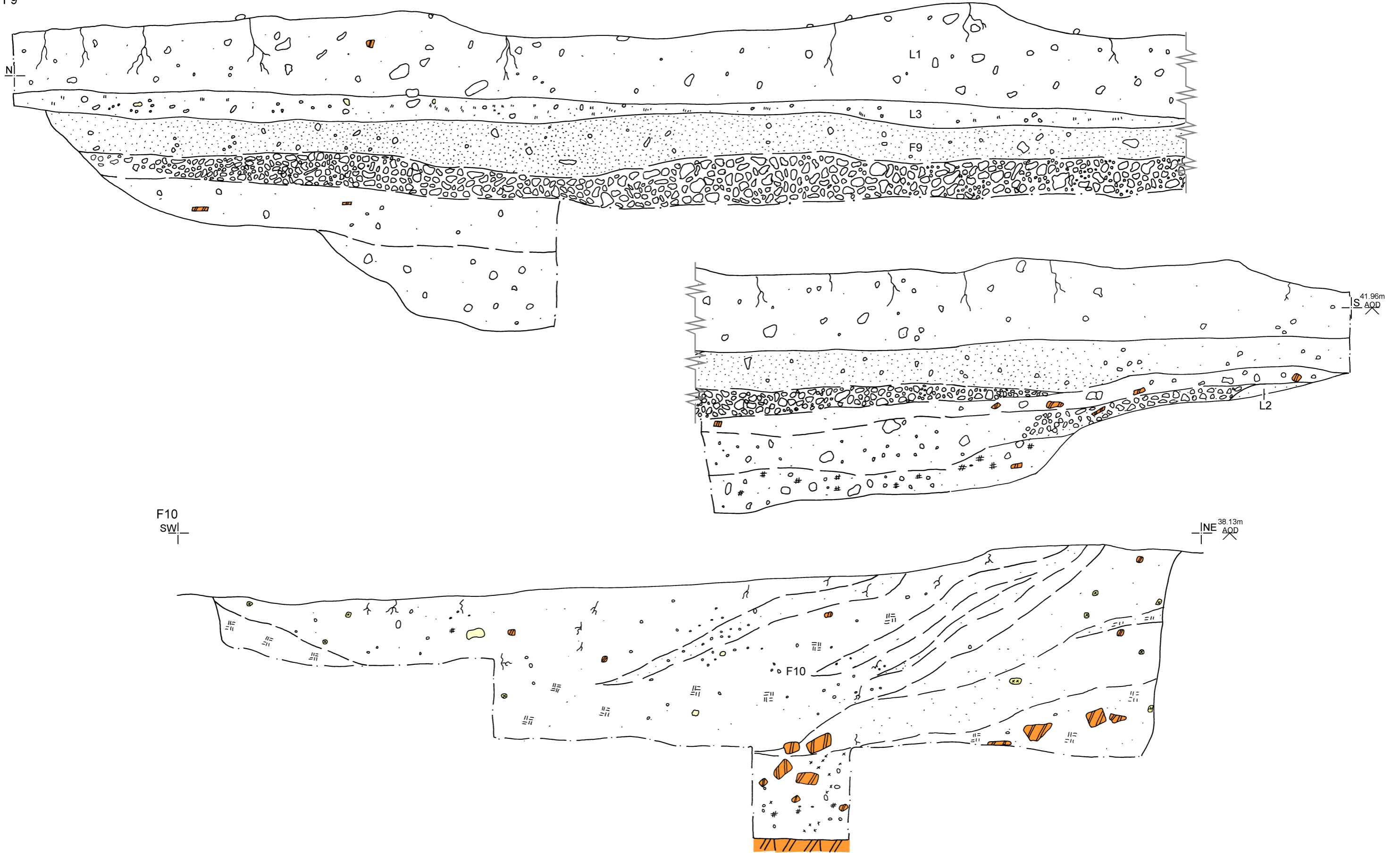

Fig 8 Feature and representative sections



---

# LAND EAST OF THE CONSTABLE MEDICAL CENTRE, HEATH ROAD, EAST BERGHOLT

## DETAILED MAGNETOMETER SURVEY



Report Number: 1145

October 2016

---



**LAND EAST OF THE CONSTABLE MEDICAL CENTRE, HEATH ROAD,  
EAST BERGHOLT**

**DETAILED MAGNETOMETER SURVEY**

Prepared for:  
Colchester Archaeological Trust  
Roman Circus House  
Circular Road North  
Colchester  
Essex  
CO2 7GZ

By:  
Matthew J. Baker MA, BA (hons)

Britannia Archaeology Ltd  
**Unit 2, The Old Wool Warehouse**  
**St Andrews Street South**  
**Bury St Edmunds**  
**Suffolk**  
**IP33 3PH**

**T: 01449 763034**

[info@britannia-archaeology.com](mailto:info@britannia-archaeology.com)

[www.britannia-archaeology.com](http://www.britannia-archaeology.com)

Registered in England and Wales: 7874460

October 2016

<b>Site Code</b>	EBG056	<b>NGR</b>	TM 083 352
<b>Event Number</b>	ESF24728		
<b>Planning Ref.</b>	B/16/01092/OUT	<b>OASIS</b>	britanni1-263239
<b>Approved By:</b>		<b>Date</b>	October 2016



---

## **DISCLAIMER**

***The material contained within this report was prepared for an individual client and solely for the benefit of that client and the contents should not be relied upon by any third party. The results and interpretation of the report cannot be considered an absolute representation of the archaeological or any other remains. Britannia Archaeology Ltd will not be held liable for any error of fact resulting in loss or damage, direct, indirect or consequential, through misuse of, or actions based on the material contained within by any third party.***

---



## **CONTENTS**

<b>1.0</b>	<b>INTRODUCTION</b>
<b>2.0</b>	<b>SITE DESCRIPTION</b>
<b>3.0</b>	<b>ARCHAEOLOGICAL BACKGROUND</b>
<b>4.0</b>	<b>PROJECT AIMS</b>
<b>5.0</b>	<b>METHODOLOGY</b>
<b>6.0</b>	<b>RESULTS</b>
<b>7.0</b>	<b>CONCLUSIONS</b>
<b>8.0</b>	<b>PROJECT ARCHIVE AND DEPOSITION</b>
<b>9.0</b>	<b>ACKNOWLEDGEMENTS</b>
	<b>BIBLIOGRAPHY</b>

### **APPENDIX 1 – OASIS FORM**

### **APPENDIX 2 – WRITTEN SCHEME OF INVESTIGATION**

<b>Figure 1</b>	<b>General Location Plan</b>	<b>1:5000</b>
<b>Figure 2</b>	<b>Grid Plan</b>	<b>1:2000</b>
<b>Figure 3</b>	<b>Unprocessed Data</b>	<b>1:2000</b>
<b>Figure 4</b>	<b>XY Data Plot</b>	<b>1:2000</b>
<b>Figure 5</b>	<b>Minimal Processed Data Plan</b>	<b>1:2000</b>
<b>Figure 6</b>	<b>Compressed Data Plan</b>	<b>1:2000</b>
<b>Figure 7</b>	<b>Interpretation</b>	



## **ABSTRACT**

*In October 2016 Britannia Archaeology Ltd (BA) undertook a detailed magnetometer survey on Land East of the Constable Medical Centre, Heath Road, East Bergholt, (NGR TM 083 352).*

*The geophysical survey has identified several anomalies that could be archaeological in origin. The features present within the survey are identified as low amplitude positive anomalies, which could be infilled ditch type features (**1000 – 1002** and **1004**), with anomalies **1001** and **1002** possibly representing an enclosure. A series of low amplitude anomalies (**1003**) on the northern boundary of the site have been identified as ploughing activity, of an unknown date. A discrete high amplitude anomaly (**1006**) was identified of unknown origin, it is possible that the source of the anomaly is archaeological in origin.*



## **1.0 INTRODUCTION**

In October 2016 Britannia Archaeology Ltd (BA) undertook a detailed magnetometer survey on Land East of the Constable Medical Centre, Heath Road, East Bergholt, (NGR TM 083 352), over 9.2 ha of land for proposed development.

## **2.0 SITE DESCRIPTION**

The site was located in two agricultural fields to the south of Heath Road in East Bergholt, Suffolk. The fields were bound to the east by Mill Road and agricultural fields, to the south by agricultural fields and to the west by residential properties.

The bedrock geology is Thames Group – Clay, Silty. This sedimentary bedrock was formed approximately 34 to 56 million years ago in the Palaeogene period when the local environment was previously dominated by deep seas (BSG 2016).

Superficial deposits are described as Lowestoft Formation – Sand and Gravel. These superficial deposits were formed up to 2 million years ago in the Quaternary Period when the local environment was previously dominated by ice age conditions (BSG 2016).

## **3.0 ARCHAEOLOGICAL BACKGROUND**

An archaeological desk-based assessment has been undertaken (Parmenter 2016) in summary:

It appears that the proposed development site has never been subject to direct settlement or development of any kind. Historic maps point to the long-term use of the proposed development site being pasture/arable farmland.

There are no Heritage Assets within, or in close proximity to the proposed development site but there are a number within the Search Area, and though none of these will be affected by the proposed development, they may give an indication as to the archaeological potential for the development site.





There is very little evidence for any activity in the search area until the medieval period. However, evidence for the medieval occupation of East Bergholt is fairly limited.

Almost all the Heritage Assets returned by the Suffolk HER were post-medieval in date. The village clearly saw significant growth at this time, with nearly 40 listed buildings being added to the village over the post-medieval period.

#### **4.0 PROJECT AIMS**

A non-intrusive geophysical survey was required of the development; this is likely to lead to a programme of trial trenching, subject to a separate WSI, to enable the archaeological resource, both in quality and extent, to be accurately quantified. However, any decision about the need for, and extent of, trial trenching will be taken following the geophysical survey (Brief Section 3.1).

#### **5.0 METHODOLOGY**

The survey grid was set out to the Ordnance Survey OSGB36 datum to an accuracy of  $\pm 0.01\text{m}$  using a Leica Viva Glonass Smart Rover GS08.

A Bartington Dual Grad 601-2 fluxgate gradiometer was used to undertake the survey, because of its high sensitivity and rapid ground coverage. The soils and underlying geology are receptive to magnetometer survey, but good results are heavily dependent on the contrast between the fills of a feature (with humic and charcoal rich deposits providing the best results) and the relative weakness of the local magnetic background field.

Only minimal processing of the datasets has been undertaken, data processing allows for the correction of errors introduced during the survey and instrument errors. The survey data has been processed using TerraSurveyor software V 3.0.29.3, where the following data processes were applied:



Destripe: Removes striping effects from the raw data caused by discrepancies between different sensors and walking directions caused by alternate zig-zag traverses.

Destagger: Corrects the displacement of anomalies caused by alternate zig-zag traverse.

Clip: The range of the data can be set to specified maximum and minimum values in order to improve the contrast of weaker anomalies within the data.

Compress: Weak anomalies were further enhanced by applying an arctangent weighing to the data.

Grad. Shade: The overall appearance of the data was improved

Two processed greyscale plots have been produced the first processed greyscale shows minimal processing of the data, the second shows further enhancement of weak anomalies present in the data by applying an arctangent compression to the data. The raw and two processed greyscale plots have been produced for comparison. An XY trace plot consisting of the processed data will be used in combination with raw and processed greyscale data. An interpretation plan characterising the anomalies has been produced based on the evidence collated from the greyscales and XY trace plots.

## **6.0 RESULTS (Figs. 3-7)**

The geophysical survey has revealed a few anomalies of possible archaeological origin. The following numbered anomalies refer to the numerical labels of the interpretation plot.

### **6.1 Gradiometer Results**

In the north-western corner of the survey area the data revealed a low amplitude positive linear anomaly (**1000**). This linear anomaly has a NW – SE orientation and is visible in the data for c.39m. This anomaly is regular in appearance, however, is of varying signal strength, which is suggestive of the anomaly being disturbed at source. Anomaly **1000**



has a similar alignment to cropmarks recorded in the field immediately to the north west of the survey area SHER 12290.

The central area of the survey has revealed a weak positive linear anomaly (**1001**), that has a NE – SW orientation for c.29m before turning east on a NW – SE orientation for c.24m, to then finally turn to a SW – NE orientation for c.15m before disappearing out of the data. It is possible that this is representing an enclosure c.20m in width. Located to the north-west of anomaly **1001** is positive linear anomaly **1002**. This anomaly is irregular in appearance and can be seen running for c.21m with a N – S orientation. It is unknown if anomalies **1001** and **1002** are related.

On the northern boundary of the site are a series of low amplitude positive linear anomalies (**1003**), these anomalies run parallel c.3 – 5m apart from one another with NW – SE orientations, visible in the data for c.31m before being masked by magnetic disturbance **1010** from the road on the northern boundary of the site. These anomalies most likely represent previous ploughing activity within the field, their irregular and intermittent appearance is suggestive of the source of the anomalies are disturbed.

Positive anomaly **1004** has been identified in the south-east corner of the survey area. This anomaly measures c.4m in width, the length of this anomaly is unknown as it is only partially present within the survey. The anomaly appears to be regular in appearance and the response given is consistent with those resulting from an infilled feature of archaeological origin. Immediately to the north-west of anomaly **1004** is a low amplitude irregular anomaly (**1005**), this anomaly has a NW – SE orientation and is c.20m ending with an irregular positive response c.5m in width. These anomalies are most likely natural in origin.

#### *High amplitude anomaly*

In the south-east of the survey area, north-west of anomalies **1004** and **1005** is a high amplitude positive sub-rectangular anomaly with associated negative response **1006**. The anomaly measures c.14m x c.4m, with a NW – SE orientation. The interpretation of this anomaly is uncertain. The high amplitude anomaly could be a result of *in situ* burning causing the remnant magnetic material. Therefore this anomaly could be of archaeological origin.



### *Geological anomalies*

Several geomorphological features have been identified in the data (**1007**), these features have a broadly NE – SW orientation, with various associated channels. These anomalies are characterised as low amplitude positive spreads, the signal of which has derived from slightly higher magnetic material being deposited by glacial melt waters.

### *Modern disturbance*

The data has displayed several strong magnetic responses which are described below. A strong positive response with associated negative response located on the western edge with a NE – SW orientation has been produced by modern service **1008**.

A series of strong bipolar responses can be seen running along the western and northern boundaries of the site (**1009** and **1010**). These have resulted from the boundaries of the properties adjacent to the survey area (**1009**), and from close proximity of a road and passing vehicles (**1010**), which have all produced a distortion to the local magnetic field. It is probable that the halo effect produced by these responses could be masking the presence of archaeological anomalies in these areas.

The survey has revealed numerous high amplitude magnetic spikes (**1011**). Each of these discrete magnetic spikes consists of a well-defined dipolar response. Their high amplitudes suggest the presence of ferrous debris in the ploughsoil.

## **7.0 CONCLUSION**

The geophysical survey has identified several anomalies that could be archaeological in origin. The features present within the survey are identified as low amplitude positive anomalies, which could be infilled ditch type features (**1000 – 1002** and **1004**), with anomalies **1001** and **1002** possibly representing an enclosure. A series of low amplitude anomalies **1003** on the northern boundary of the site have been identified as ploughing activity, of an unknown date. A discrete high amplitude anomaly (**1006**) was identified of unknown origin, it is possible that the source of the anomaly is archaeological in origin.

The overall signal strength of the features is reduced, this could be due to the reduced natural magnetic enhancement of topsoils developing over the Thames group clay formations, leading to the reduced feature contrasts.



## **8.0 PROJECT ARCHIVE AND DEPOSITION**

A full archive will be prepared for all the work undertaken in accordance with the *Selection, Retention and Dispersion of Archaeological Collections*, Archaeological Society for Museum Archaeologists 1993. Arrangements will be made for the archive to be deposited with the relevant museum/HER office.

## **9.0 ACKNOWLEDGEMENTS**

Britannia Archaeology Ltd would like to thank Mr Chris Lister of the Colchester Archaeological Trust for commissioning the project.

We would also like to thank Rachael Abrahams at the Suffolk County Council Archaeology Service / Conservation Team (SCCAS/CT) for her input and advice.

The survey was undertaken by Matthew J. Baker and Adam Leigh of Britannia Archaeology Ltd





## **Bibliography**

Abraham, R. 2016. Brief for a Geophysical Survey at Land East of the Constable Medical Centre, Heath Road, East Bergholt

Ayala. G. *et al.* 2004. *Geoarchaeology; Using Earth Sciences to Understand the Archaeological Record*. English Heritage.

Chartered Institute for Archaeologists. 2014. *Standard and Guidance for Geophysical Survey*

Clark. A. J. 1996. *Seeing Beneath the Soil, Prospecting Methods in Archaeology*. BT Batsford Ltd, London.

David. A. *et al.* 2008. *Geophysical Survey In Archaeological Field Evaluation*, Second Edition. English Heritage.

Department for Communities and Local Government, 2012. *National Planning Policy Framework (NPPF)*

Gaffney. C, Gater. J. and Ovenden. S. 2002. *The Use of Geophysical Techniques in Archaeological Evaluations*. IFA Technical Paper No. 6.

Gaffney. C. and Gater. J. 2003. *Revealing the Buried Past, Geophysics for Archaeologists*. Tempus Publishing Ltd.

Gurney, D. 2003. *Standards for Archaeology in the East of England*, East Anglian Archaeology Occasional Paper 14.

Historic England, 2008. *Geophysical Survey in Archaeological Field Evaluation*. Research and Professional Service Guideline No 1, 2nd edition.

Chartered Institute for Archaeologists. 2015. *Standard and Guidance for Archaeological Geophysical Survey*.

Linford. N. 2006. Notes from an English Heritage Seminar.



Parmenter, P. 2016. *A desk-based assessment of the archaeological remains on and around land at Heath Road, East Bergholt*. CAT Report 966.

Schmidt. A. 2001. *Geophysical Data in Archaeology: A Guide to Good Practice*. Archaeology Data Service. Oxbow Books.

Witten. A.J. 2006. *Handbook of Geophysics and Archaeology*. Equinox Publishing Ltd. London.

### **Websites**

The British Geological Survey, 2016, (Natural Environment Research Council) – Geology of Britain Viewer - [www.bgs.ac.uk/opengeoscience/home.html?Accordion2=1#maps](http://www.bgs.ac.uk/opengeoscience/home.html?Accordion2=1#maps)



## **APPENDIX 1 – OASIS FORM**

Will be completed on approval of the draft report



**APPENDIX 2 – WRITTEN SCHEME OF INVESTIGATION**

**LAND EAST OF THE CONSTABLE MEDICAL  
CENTRE, HEATH ROAD, EAST BERGHOLT**

WRITTEN SCHEME OF INVESTIGATION  
DETAILED MAGNETOMETER SURVEY



Project Number: 1160

September 2016



**LAND EAST OF THE CONSTABLE MEDICAL CENTRE, HEATH ROAD,  
EAST BERGHOLT**

**Written Scheme of Investigation  
Detailed Magnetometer Survey**

Prepared for:  
Colchester Archaeological Trust  
Roman Circus House  
Circular Road North  
Colchester  
Essex  
CO2 7GZ

By:  
Matthew J. Baker MA, BA (Hons)

**Britannia Archaeology Ltd**  
**Unit 2, The Old Wool Warehouse**  
**St Andrews Street South**  
**Bury St Edmunds**  
**Suffolk**  
**IP33 3PH**

**T: 01449 763034**

[info@britannia-archaeology.com](mailto:info@britannia-archaeology.com)

[www.britannia-archaeology.com](http://www.britannia-archaeology.com)

Registered in England and Wales: 7874460

September 2016

<b>Site Code</b>	EBG056	<b>NGR</b>	TM 083 352
<b>Event Number</b>	ESF24728		
<b>Planning Ref.</b>	B/16/01092/OUT	<b>OASIS</b>	britanni1-263239
<b>Approved By:</b>	Dan McConnell	<b>Date</b>	September 2016





## **CONTENTS**

<b>10.0</b>	<b>Introduction</b>
<b>11.0</b>	<b>Site Description</b>
<b>12.0</b>	<b>Planning Policies</b>
<b>13.0</b>	<b>Archaeological Background</b>
<b>14.0</b>	<b>Project Aims</b>
<b>15.0</b>	<b>Methodology</b>
<b>16.0</b>	<b>Presentation of Results</b>
<b>17.0</b>	<b>Project Archive and Deposition</b>
<b>18.0</b>	<b>Health and Safety</b>
<b>19.0</b>	<b>Resources</b>
<b>20.0</b>	<b>Timetable and Programme of Work</b>
	<b>Bibliography</b>

<b>Appendix 1</b>	<b>Technical Details</b>
<b>Appendix 2</b>	<b>Insurance Details</b>
<b>Appendix 3</b>	<b>Staff</b>
<b>Appendix 4</b>	<b>Specialists</b>

<b>Figure 1</b>	<b>Site Location Plan</b>	<b>1:5000</b>
<b>Figure 2</b>	<b>Proposed Survey Grid Location Plan</b>	<b>1:2000</b>

DRAFT



## **1.0 INTRODUCTION**

This Written Scheme of Investigation (WSI) has been prepared by Britannia Archaeology Ltd (BA) on behalf of the Colchester Archaeological Trust, Roman Circus House, Circular Road North, Colchester, Essex in response to a brief (Abraham, R. 12<sup>th</sup> September 2016) for a geophysical survey over land for proposed development (9.2 ha) on Land East of the Constable Medical Centre, Heath Road, East Bergholt (NGR TM 083 352).

## **2.0 SITE DESCRIPTION**

The site is located in two agricultural fields to the south of Heath Road in East Bergholt, Suffolk. The fields are bound to the east by Mill Road and agricultural fields, to the south by agricultural fields and to the west by residential properties.

The bedrock geology is Thames Group – Clay, Silty. This sedimentary bedrock was formed approximately 34 to 56 million years ago in the Palaeogene period when the local environment was previously dominated by deep seas (BSG 2016).

Superficial deposits are described as Lowestoft Formation – Sand and Gravel. These superficial deposits were formed up to 2 million years ago in the Quaternary Period when the local environment was previously dominated by ice age conditions (BSG 2016).

## **3.0 PLANNING POLICIES**

The archaeological investigation is to be carried out on the recommendation of the local planning authority, following guidance laid down by the National Planning and Policy Framework (NPPF, DCLD 2012) which replaces Planning Policy Statement 5: Planning for the Historic Environment (PPS5, DCLG 2010). The relevant local planning policy is the *Mid Suffolk Local Plan; (1998)*.

## **4.0 ARCHAEOLOGICAL BACKGROUND**

An archaeological desk-based assessment has been undertaken (Parmenter 2016) in summary:

It appears that the proposed development site has never been subject to direct settlement or development of any kind. Historic maps point to the long-term use of the proposed development site being pasture/arable farmland.

There are no Heritage Assets within, or in close proximity to the proposed development site but there are a number within the Search Area, and though none of these will be affected by the proposed development, they may give an indication as to the archaeological potential for the development site.



There is very little evidence for any activity in the search area until the medieval period. However, evidence for the medieval occupation of East Bergholt is fairly limited.

Almost all the Heritage Assets returned by the Suffolk HER were post-medieval in date. The village clearly saw significant growth at this time, with nearly 40 listed buildings being added to the village over the post-medieval period.

## **5.0 PROJECT AIMS**

A non-intrusive geophysical survey is required of the development; this is likely to lead to a programme of trial trenching, subject to a separate WSI, to enable the archaeological resource, both in quality and extent, to be accurately quantified. However, any decision about the need for, and extent of, trial trenching will be taken following the geophysical survey (Brief Section 3.1).

## **6.0 METHODOLOGY**

### **6.1 Fieldwork**

A detailed fluxgate gradiometer survey is required over c.9.2 Hectares, scheduled to be undertaken in September 2016.

### **6.2 Instrument Type Justification**

Britannia Archaeology Ltd will employ a Bartington Dual Grad 601-2 fluxgate gradiometer to undertake the survey, because of its high sensitivity and rapid ground coverage. The soils and underlying geology are receptive to magnetometer survey, but good results are heavily dependent on the contrast between the fills of a feature (with humic and charcoal rich deposits providing the best results) and the relative weakness of the local magnetic background field.

### **6.3 Instrument Calibration**

The Magnetometer will be left on for a minimum of 20 minutes in the morning for the sensors to settle before any recorded survey takes place. Sensor heights will be measured and equalised at the start of the first day so that a consistent height above the ground is maintained during the survey. Each sensor shall be positioned on the same side of the instrument throughout the survey. A calibration point will be located with a magnetic variation no greater than 1 nano tesla (nT) within a 6m<sup>2</sup> area. This area of low magnetic susceptibility will be used to calibrate the instruments sensors during the survey. Sensor calibration will be undertaken after every 6 full grids, however, sudden changes in weather or knocking the sensors will require recalibration.



#### **6.4 Sampling Interval and Grid Size**

The sampling interval shall be 0.25m along 1m traverse intervals, within 30 x 30m grids. Where a 30m grid cannot be recorded in full, as much of the partial grid will be recorded as possible.

#### **6.5 Survey Grid Location**

The survey grid shall be set out to the Ordnance Survey OSGB36 datum to an accuracy of  $\pm 0.01\text{m}$  employing a Leica Viva Glonass Smart Rover GS08. Data will be converted to the National Grid Transformation OSTN02, and the instrument will be regularly tested using stations with known ETRS89 coordinates. The grid will be located parallel to the long axis of the proposed development to allow for ease of survey.

#### **6.6 Data Capture**

The grid order will be recorded on a BA pro-forma so that the composite plan can be inputted at the close of the day. Instrument readings will be recorded on an internal data logger, downloaded to a laptop at midday and in the evening. Data will be filed in job specific folders and backed up onto an external storage device and finally a remote server.

#### **6.7 Data Presentation and Processing**

Only minimal processing of the datasets shall be undertaken, data processing allows for the correction of errors introduced during the survey and instrument errors. The survey data will be processed using TerraSurveyor software v3.0.29.3. These processes will be entirely dependent on the data collected from the survey.

The raw and processed greyscale plots will be produced for comparison. An XY trace plot consisting of the processed data will be used in combination with raw and processed greyscale data. An interpretation plan characterising the anomalies will be produced based on the evidence collated from the greyscale and XY trace plots.

#### **6.8 Software**

The software used to process the data and produce the composites will be DW Consulting's Terrasurveyor v3.0.29.3. Datasets will be exported into AutoCAD and placed onto their corresponding grid positions. An interpretation plot will then be produced using AutoCAD.

### **7.0 PRESENTATION OF RESULTS**

The prepared client/archive report will be commensurate with the results of the fieldwork, and will be consistent with the principles of the *Management of Research Projects in the Historic Environment (MoRPHE)*, English Heritage, Edmund Lee, 2006 (minor revisions 2009), *Geophysical Survey In Field Evaluation*, English Heritage, Andrew David *et al*, 2008,



and the *Standard and Guidance for Archaeological Geophysical Survey*, Institute for Archaeologists, 2011, containing the following:

- *Summary.* A concise summary of the work undertaken and the results.
- *Introduction.* Introduction to the project including the reasons for work, funding, planning background.
- *Background.* The history, layout and development of the site.
- *Aims and Objectives.*
- *Methodology.* Survey strategy and techniques used.
- *Results.* Detailed description of findings outlining the nature, location and extent of the anomalies.
- *Discussion and Conclusions.* A synopsis interpreting the anomalies, impact assessment, site potential, possible locations of subsequent trial trenches.
- *Bibliography.*
- *Appendices.* Technical Details, Geo-referencing Information, Metadata Sheet, HER/OASIS Summary Sheet.
- *Illustrative Material.* Raw Data Plots, Processed Data Plots, XY Trace Plots, Interpretation Plots, Photographs.

Prior to the release of the final report, a draft report will be submitted for comment and approval to the Suffolk Historic Environment Record. On approval digital copies will be supplied to the client and both a the digital version and hard copy of the final report will be submitted to the Suffolk Historic Environment Record in due course (including a vector plan and AutoCAD .dxf file) and the National Monuments Record (NMR). A .pdf version will be uploaded to the ADS website and an OASIS form will be completed online and sent to the HER.

## **8.0 PROJECT ARCHIVE AND DEPOSITION**

A full archive will be prepared for all work undertaken in accordance with guidance from the *Selection, Retention and Dispersion of Archaeological Collections*, Archaeological Society for Museum Archaeologists, 1993. Arrangements will be made for the archive to be deposited with the relevant museum/HER Office, in this case will be the Suffolk County Council HER Store.





## **9.0 HEALTH AND SAFETY**

BA operates a comprehensive Health and Safety Policy in accordance with the Health and Safety Executive. BA operates under the Federation of Archaeological Managers and Employers (FAME) *Health and Safety Field Manual*, which is regularly updated by supplements.

BA are covered by employer's liability, public liability and professional indemnity insurance arranged through Towergate Insurance (see Appendix 2).

### **9.1 Code of Practice, Risk Assessment and Site Induction**

BA's Code of Practice covers all aspects of survey work and ensures all risks are adequately controlled. A site visit will be undertaken and an assessment of the potential risks highlighted, a full site risk assessment will be produced based on this information. The assessment of risk is continually monitored and this document can be updated if any change in risk occurs. A copy of the Risk Assessment is kept on site, read and countersigned by all staff and visitors during the BA site induction.

BA will liaise with the contractor or client on arrival and will follow any additional Health and Safety instructions given.

A qualified First Aider will be present on every site.

All BA staff members are CSCS registered.

## **10.0 RESOURCES**

All archaeological projects are undertaken by a team of professional qualified archaeologists, a synopsis can be found at Appendix 3. Full CV's are available on request.

All site work will be undertaken by a Project Officer with a qualified member of staff in close communication with a Project Manager. This project officer will also be responsible for post-survey publication.

## **11.0 TIMETABLE AND PROGRAMME OF WORK**

The geophysical survey is scheduled to be undertaken in late September 2016 and report production will commence thereafter. Preliminary greyscale and interpretation plots shall be issued at the end of the survey. It is understood that the client is aware of the working methods and provision has been made to allow access to undertake the survey as required.



## Bibliography

Abraham, R. 2016. Brief for a Geophysical Survey at Land East of the Constable Medical Centre, Heath Road, East Bergholt

Ayala. G. *et al.* 2004. *Geoarchaeology; Using Earth Sciences to Understand the Archaeological Record*. English Heritage.

Clark. A. J. 1996. *Seeing Beneath the Soil, Prospecting Methods in Archaeology*. BT Batsford Ltd, London.

David. A. 1995. *Geophysical Survey in Archaeological Field Evaluation: Research and Professional Services Guidelines*. No.1. English Heritage.

David. A. *et al.* 2008. *Geophysical Survey In Archaeological Field Evaluation*, Second Edition. English Heritage.

Department for Communities and Local Government, 2012. *National Planning Policy Framework (NPPF)*

Gaffney. C, Gater. J. and Ovenden. S. 2002. *The Use of Geophysical Techniques in Archaeological Evaluations*. IFA Technical Paper No. 6.

Gaffney. C. and Gater. J. 2003. *Revealing the Buried Past, Geophysics for Archaeologists*. Tempus Publishing Ltd.

Gurney, D. 2003. *Standards for Archaeology in the East of England*, East Anglian Archaeology Occasional Paper 14.

Institute for Archaeologists. 2011. *Standard and Guidance for Archaeological Geophysical Survey*.

Linford. N. 2006. Notes from an English Heritage Seminar.

Parmenter, P. 2016. *A desk-based assessment of the archaeological remains on and around land at Heath Road, East Bergholt*. CAT Report 966.

Schmidt. A. 2001. *Geophysical Data in Archaeology: A Guide to Good Practice*. Archaeology Data Service. Oxbow Books.

Whitten. D.G.A. 1978. *The Penguin Dictionary of Geology*. Penguin Books Ltd. London.

Witten. A.J. 2006. *Handbook of Geophysics and Archaeology*. Equinox Publishing Ltd. London.



## Websites

The British Geological Survey, 2016, (Natural Environment Research Council) – Geology of Britain Viewer - [www.bgs.ac.uk/opengeoscience/home.html?Accordion2=1#maps](http://www.bgs.ac.uk/opengeoscience/home.html?Accordion2=1#maps)

DRAFT



## **APPENDIX 1            TECHNICAL DETAILS**

### **MAGNETOMETER**

The magnetometer differs from the 'active' magnetic susceptibility meter by being a 'passive' instrument. Rather than injecting a signal into the ground it detects slight variations in the Earth's magnetic field caused by cultural and natural disturbance (Clark).

Thermoremanent magnetism is produced when a material containing iron oxides is strongly heated. Clay for example has a high iron oxide content that in a natural state is weakly magnetic, when heated these weakly magnetic compounds become highly magnetic oxides that a magnetometer can detect.

The demagnetisation of iron oxides occurs above a temperature known as the Curie point; for example haematite has a Curie point of 675 Celsius and magnetite 565C. At the time of cooling the iron oxides become permanently re-magnetised with their magnetic properties re-aligned in the direction of the Earth's magnetic field (Gaffney and Gater). The direction of the Earth's magnetic field shifts over time and these subtle alignment differences can be recorded. Kilns, hearths, baked clay and ovens can reach Curie point temperatures, and are the strongest responses apart from large iron objects that can be detected. Other cultural anomalies that can be prospected include occupation areas, pits, ditches, furnaces, sunken feature buildings, ridge and furrow field systems and ritual activity (David, 2011). Commonly recorded anomalies include modern ferrous service pipes, field drainage pipes, removed field boundaries, perimeter fences and field boundaries.

#### **Fluxgate Gradiometers**

Fluxgate gradiometers are sensitive instruments that utilise two sensors placed in a vertical plane, spaced 1 metre apart. The sensor above reads the Earth's magnetic (background) response while the sensor below records the local magnetic field. Both sensors are carefully adjusted to read zero before survey commences at a 'zeroing' point, selected for its relatively 'quiet' magnetic background reading. When differences in the magnetic field strength occur between the two sensors a positive or negative reading is logged. Positive anomalies have a positive magnetic value and conversely negative anomalies have a negative magnetic value relative to the site's magnetic background. Examples of positive magnetic anomalies include hearths, kilns, baked clay, areas of burning, ferrous material, ditches, sunken feature buildings, furrows, ferrous service pipes, perimeter fences and field boundaries. Negative magnetic anomalies include earthwork embankments, plastic water pipes and geological features.

The instruments are usually held approximately 0.30m to 0.50m above the ground surface and can detect to a depth of between 1-2metres. Best practice dictates that the optimal direction of traverse in Britain is east to west.



## **Magnetic Anomalies**

### **Linear trends**

Linear trends can be both positive and negative magnetic responses. If they are broad, relatively weak or negative in nature they may be of agricultural or geological origin, for example periglacial channels, land drains or ploughing furrows. If the responses are strong positive trends they are more likely to be of archaeological origin. Archaeological settlement ditches tend to be rich in highly magnetic iron oxides that accumulate in them via anthropogenic activity and humic backfills. Conversely surviving banks will be negative in nature, the material is derived from subsoil deposits that is less likely to be positively magnetic. Curvilinear trends can also be recorded and are indicative of archaeological structures such as drip-gullies.

### **Discrete anomalies**

Discrete anomalies appear as increased positive responses present within a localised area. They are caused by a general increase in the amount of magnetic iron oxides present within the humic back-fill of for example a rubbish pit.

### **'Iron spike' anomalies**

These strong isolated dipolar responses are usually caused by ferrous material present in the topsoil horizon. They can have an archaeological origin but are usually introduced into the topsoil during manuring.

### **Areas of magnetic disturbance**

An area of magnetic disturbance is usually associated with material that has been fired. For example areas of burning, demolition (brick) rubble or slag waste spreads. They can also be caused by ferrous material, e.g. close proximity to barbwire or metal fences and field boundaries, buried services, pylons and modern rubbish deposits.



## APPENDIX 2      INSURANCE DETAILS

	<b>Employers Liability Insurance</b>	<b>Public Liability</b>	<b>Professional Indemnity</b>
Insurer	Towergate Insurance	Towergate Insurance	Towergate Insurance
Extent of Cover	£10,000,000	£5,000,000	£5,000,000
Policy Number	000436	000436	201101352/1236

DRAFT







Ireland including major infrastructure schemes. Since relocating to East Anglia in 2004 he has carried out and managed several small to large scale excavations across the south and east of England. In 2008 Dan became a County Archaeologist for the Cambridgeshire County Council Historic Environment Team before joining Britannia in 2014. His main research interests focus on the early pre-historic period (in particular the Neolithic) of the British-Isles and late post-medieval archaeology.

**Director                      Martin Brook BA (Hons) PCIfA**

**Qualifications:**            University of Leicester, BA (Hons) Archaeology (2003 – 2006)

*Experience:*    Martin is a Director at Britannia Archaeology and has ten years commercial archaeological experience. He specialises in logistical project management, archiving and fieldwork. He has carried out numerous excavations and evaluations throughout East Anglia and the Midlands, and works closely with local and national museums when archiving sites. His research interests are focused on the British Iron age specifically funerary traditions in the south of England and in East Yorkshire. Martin specialises in metalwork finds from the period, specifically those associated with grave goods and personal adornment.

**Director                      Matthew Adams BA (Hons) ACIfA**

**Qualifications:**            University of Durham, BA (Hons) Classical Studies (1997- 2000)

*Experience:*    Matt is a Director of Britannia Archaeology and has ten years commercial archaeology experience. He was involved in several archaeological projects in the midlands from the mid 1990's onwards and in the North East of England as an undergraduate. Since 2007 he has been based in East Anglia where he has specialised in all areas of practical field work, running numerous projects both large and small. He is also an experienced surveyor, GIS and AutoCAD operator. Matt was an occasional contributor to the popular TV series Time Team and is experienced at presenting talks and seminars to interested organisations. His main research interests focus on transitional periods and include the late Iron Age and early Romano-British period, and the late Roman and early Anglo-Saxon period in Britain and the late Aegean Bronze Age in Crete.



#### **APPENDIX 4 - SPECIALISTS**

Prehistoric Pottery:	Ms Sarah Percival
Roman Pottery:	Ms Cathy Tester
Saxon and Medieval Pottery:	Ms Richenda Goffin
Post Medieval Pottery:	Ms Richenda Goffin
Flint:	Miss Justine Biddle
Animal Bone:	Dr Jim Morris and Dr Julia Cussans
Human Bone:	Dr Steph Leach
Environmental:	Ms Anne West
Pollen and Seeds:	Dr Steve Boreham
Charcoal and Wood:	Dr Roderick Bale
Soil Micromorphology:	Dr Steve Boreham
Carbon-14 Dating:	Archaeological Research Services Ltd
Conservation:	University of Leicester Archaeological Services (ULAS)
Metalwork and Leather:	University of Leicester Archaeological Services (ULAS)
Glass:	University of Leicester Archaeological Services (ULAS)
Small Finds:	University of Leicester Archaeological Services (ULAS)
Illustration:	Mr Dave Watt, Miss Charlotte Davies
Slag:	Ms Jane Cowgill
Geophysical Surveyors:	Dr Dave Bescoby
Air Photographic Assessments:	Alison Deegan (BSc)
Topographic Survey:	Mr Matt Adams (BA)
CAD:	Mr Dan McConnell & Mr Matt Adams (BA)
Coins & Medals:	British Museum, Department of Coins & Medals or Norfolk Museum Identification and Recording Service for Archaeological Finds



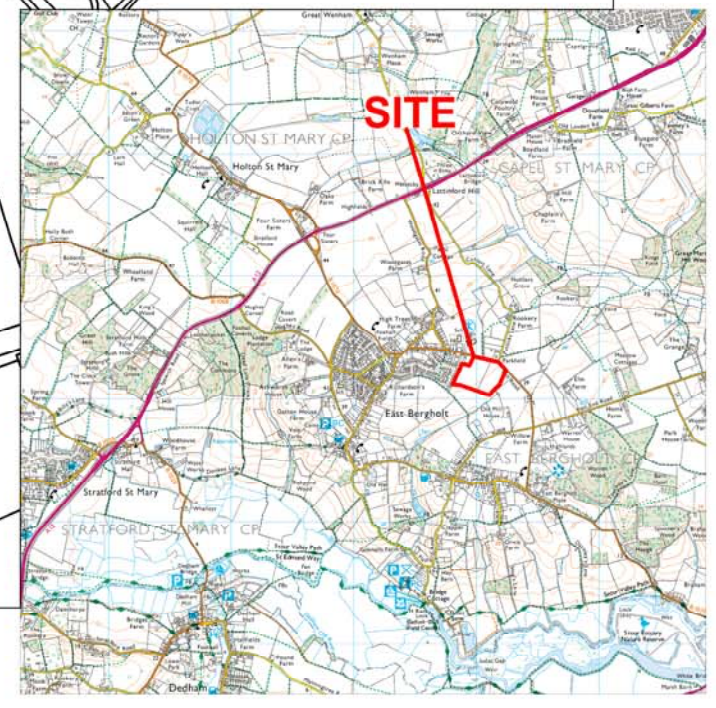
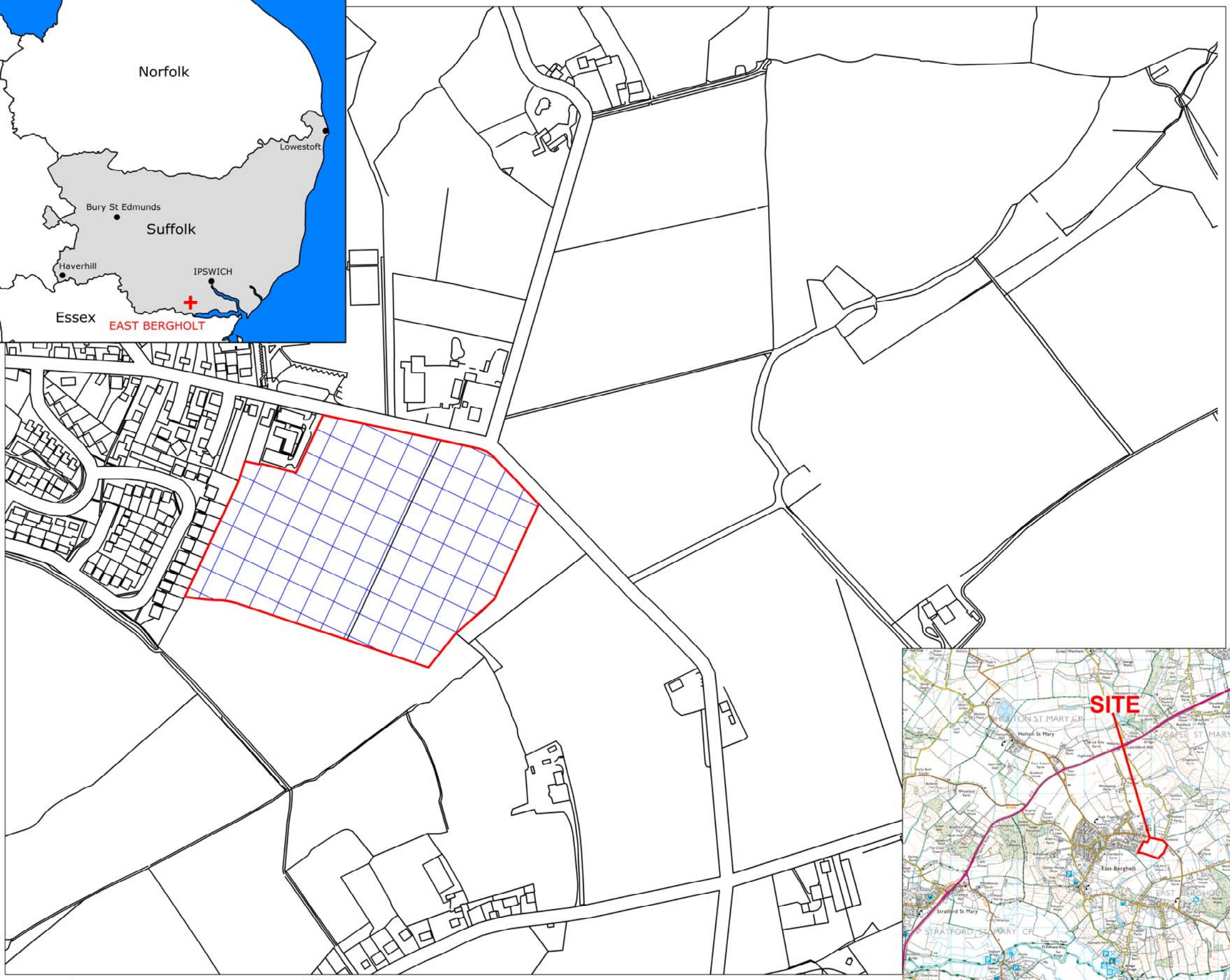

NGR:	608300 235200	REF:	P1160
PROJECT:	LAND EAST OF CONSTABLE MEDICAL CENTRE, HEATH ROAD, EAST BERGHOLT		
DESCRIPTION:	GENERAL LOCATION PLAN		
CLIENT:	COLCHESTER ARCHAEOLOGICAL TRUST		
<b>BRITANNIA ARCHAEOLOGY LTD</b>			
 UNIT 2 THE OLD WOOL WAREHOUSE ST ANDREWS STREET SOUTH BURY ST EDMUNDS SUFFOLK IP33 3PH T: 01449 763034 E: info@britannia-archaeology.com W: www.britannia-archaeology.com © Copyright Britannia Archaeology Ltd 2016			
DATE:	OCT 2016	PLOT:	A3
		VERSION:	3
AUTHOR:	MJB	FIGURE:	1
APPROVED:	DPM		

Reproduced on plans supplied by the client from the Ordnance Survey map with the permission of the controller of Her Majesty's Stationery Office. Licence number: 100052663.  
© CROWN COPYRIGHT 2016.





1:2000 0 100m

Reproduced on plans supplied by the client from the Ordnance Survey map with the permission of the controller of Her Majesty's Stationery Office. Licence number: 100052663.  
© CROWN COPYRIGHT 2016.

NGR: 608300 235200 REF: P1160

PROJECT: LAND EAST OF CONSTABLE MEDICAL CENTRE, HEATH ROAD, EAST BERGHOLT

DESCRIPTION: GRID PLAN

CLIENT: COLCHESTER ARCHAEOLOGICAL TRUST

**BRITANNIA ARCHAEOLOGY LTD**



UNIT 2  
THE OLD WOOL WAREHOUSE  
ST ANDREWS STREET SOUTH  
BURY ST EDMUNDS  
SUFFOLK  
IP33 3PH

T: 01449 763034  
E: info@britannia-archaeology.com  
W: www.britannia-archaeology.com

© Copyright Britannia Archaeology Ltd 2016

DATE: OCT 2016 PLOT: A3 VERSION: 3

AUTHOR: MJB FIGURE: 2

APPROVED: DPM



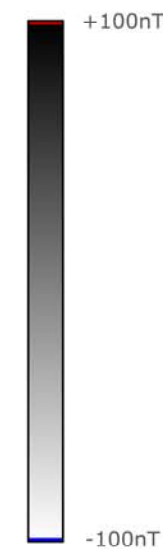
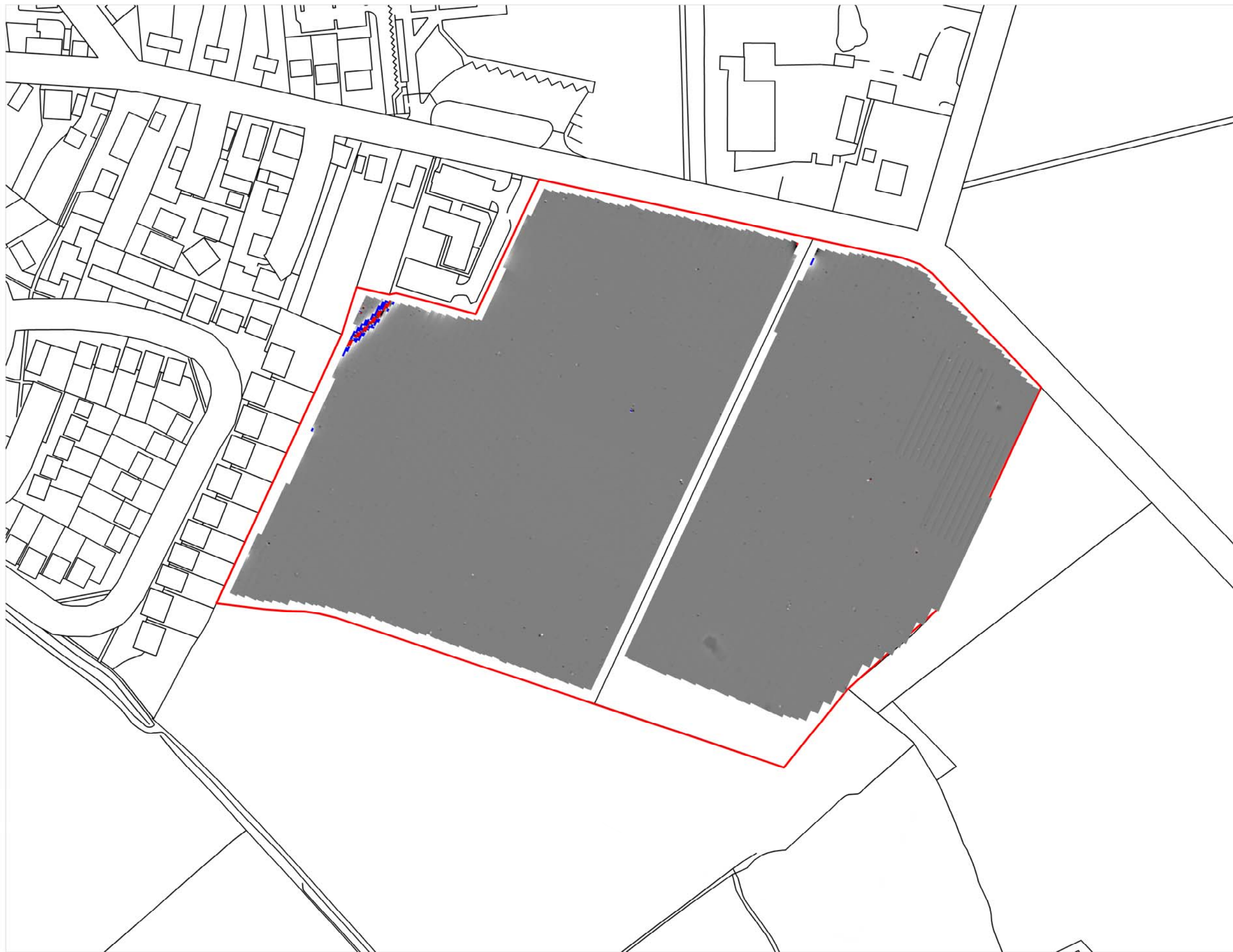

NGR: 608300 235200 REF: P1160

PROJECT: LAND EAST OF CONSTABLE MEDICAL CENTRE, HEATH ROAD, EAST BERGHOLT

DESCRIPTION: NON-PROCESSED DATA PLAN

CLIENT: COLCHESTER ARCHAEOLOGICAL TRUST

**BRITANNIA ARCHAEOLOGY LTD**



UNIT 2  
THE OLD WOOL WAREHOUSE  
ST ANDREWS STREET SOUTH  
BURY ST EDMUNDS  
SUFFOLK  
IP33 3PH

T: 01449 763034  
E: info@britannia-archaeology.com  
W: www.britannia-archaeology.com

© Copyright Britannia Archaeology Ltd 2016

DATE: OCT 2016 PLOT: A3 VERSION: 2

AUTHOR: MJB FIGURE: 3

APPROVED: DPM

1:2000 0 100m

Reproduced on plans supplied by the client from the Ordnance Survey map with the permission of the controller of Her Majesty's Stationery Office. Licence number: 100052663.  
© CROWN COPYRIGHT 2016.



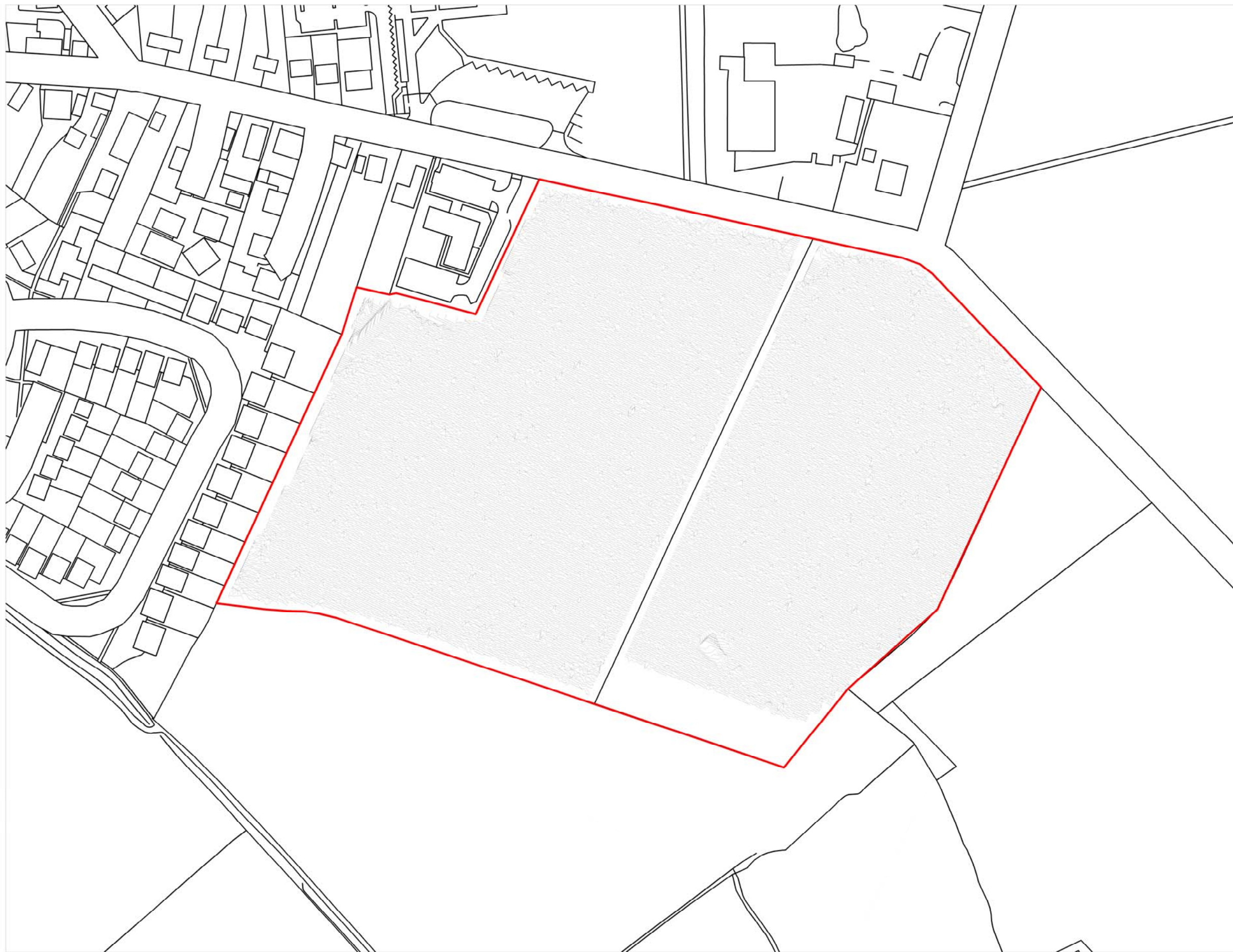

5 nT

0 nT

10nT/cm Scale Interval



Site Boundary

NGR: 608300 235200 REF: P1160

PROJECT: LAND EAST OF CONSTABLE MEDICAL CENTRE, HEATH ROAD, EAST BERGHOLT

DESCRIPTION: XY DATA PLOT

CLIENT: COLCHESTER ARCHAEOLOGICAL TRUST

**BRITANNIA ARCHAEOLOGY LTD**



UNIT 2  
THE OLD WOOL WAREHOUSE  
ST ANDREWS STREET SOUTH  
BURY ST EDMUNDS  
SUFFOLK  
IP33 3PH

T: 01449 763034  
E: info@britannia-archaeology.com  
W: www.britannia-archaeology.com

© Copyright Britannia Archaeology Ltd 2016

DATE: OCT 2016 PLOT: A3 VERSION: 2

AUTHOR: MJB FIGURE: 4

APPROVED: DPM

1:2000 0 100m

Reproduced on plans supplied by the client from the Ordnance Survey map with the permission of the controller of Her Majesty's Stationery Office. Licence number: 100052663.  
© CROWN COPYRIGHT 2016.



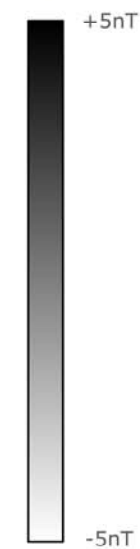

NGR: 608300 235200 REF: P1160

PROJECT: LAND EAST OF CONSTABLE MEDICAL CENTRE, HEATH ROAD, EAST BERGHOLT

DESCRIPTION: MINIMAL PROCESSED DATA PLAN

CLIENT: COLCHESTER ARCHAEOLOGICAL TRUST

**BRITANNIA ARCHAEOLOGY LTD**



UNIT 2  
THE OLD WOOL WAREHOUSE  
ST ANDREWS STREET SOUTH  
BURY ST EDMUNDS  
SUFFOLK  
IP33 3PH

T: 01449 763034  
E: info@britannia-archaeology.com  
W: www.britannia-archaeology.com

© Copyright Britannia Archaeology Ltd 2016

DATE: OCT 2016 PLOT: A3 VERSION: 1

AUTHOR: MJB FIGURE: 5

APPROVED: DPM

1:2000 0 100m

Reproduced on plans supplied by the client from the Ordnance Survey map with the permission of the controller of Her Majesty's Stationery Office. Licence number: 100052663.  
© CROWN COPYRIGHT 2016.



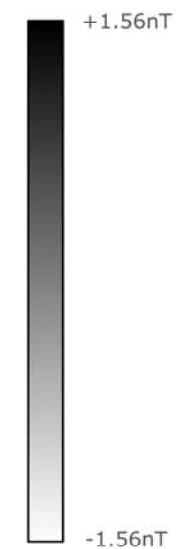

Site Boundary

NGR: 608300 235200 REF: P1160

PROJECT: LAND EAST OF CONSTABLE MEDICAL CENTRE, HEATH ROAD, EAST BERGHOLT

DESCRIPTION: COMPRESSED DATA PLAN

CLIENT: COLCHESTER ARCHAEOLOGICAL TRUST

**BRITANNIA ARCHAEOLOGY LTD**



UNIT 2  
THE OLD WOOL WAREHOUSE  
ST ANDREWS STREET SOUTH  
BURY ST EDMUNDS  
SUFFOLK  
IP33 3PH

T: 01449 763034  
E: info@britannia-archaeology.com  
W: www.britannia-archaeology.com

© Copyright Britannia Archaeology Ltd 2016

DATE: OCT 2016 PLOT: A3 VERSION: 2

AUTHOR: MJB FIGURE: 6







APPROVED: DPM

1:2000 0 100m

Reproduced on plans supplied by the client from the Ordnance Survey map with the permission of the controller of Her Majesty's Stationery Office. Licence number: 100052663. © CROWN COPYRIGHT 2016.





-  Positive Anomaly  
Possible Archaeology
-  Low Amplitude Positive Linear  
Ploughing
-  Low Amplitude Magnetic Spread  
Geological Anomaly
-  Increased Magnetic Distortion
-  Increased Magnetic Response  
Possible Archaeology
-  Increased Magnetic Response  
Modern Service
-  Discrete Magnetic Dipolar  
Response



NGR: 608300 235200 REF: P1160

PROJECT: LAND EAST OF CONSTABLE MEDICAL CENTRE, HEATH ROAD, EAST BERGHOLT

DESCRIPTION: INTERPRETATION

CLIENT: COLCHESTER ARCHAEOLOGICAL TRUST

**BRITANNIA ARCHAEOLOGY LTD**



UNIT 2  
THE OLD WOOL WAREHOUSE  
ST ANDREWS STREET SOUTH  
BURY ST EDMUNDS  
SUFFOLK  
IP33 3PH

T: 01449 763034  
E: info@britannia-archaeology.com  
W: www.britannia-archaeology.com  
© Copyright Britannia Archaeology Ltd 2016

DATE: OCT 2016 PLOT: A3 VERSION: 2

AUTHOR: MJB  
APPROVED: DPM

FIGURE: 7

1:2000 0 100m

Reproduced on plans supplied by the client from the Ordnance Survey map with the permission of the controller of Her Majesty's Stationery Office. Licence number: 100052663.  
© CROWN COPYRIGHT 2016.

# **Written Scheme of Investigation (WSI) for an archaeological evaluation on land east of the Constable Country Medical Centre, Heath Road, East Bergholt, Suffolk, CO7 6RT**

**NGR:** TM 080 352 (centre)

**Planning references:** B/16/01092/OUT

**Commissioned by:** Stephen Williams (Hills)

**Client:** Hills Residential

**Curating museum:** Suffolk County Council Archaeological Service

**Suffolk HER parish code:** EBG 060

**Suffolk event number:** ESF25709

**CAT project code:** 17/08h

**OASIS reference:** colchest3-292177

**Site manager:** Chris Lister

**SCCAS/CT monitor:** Rachael Abraham

**This WSI written:** 7.8.2017

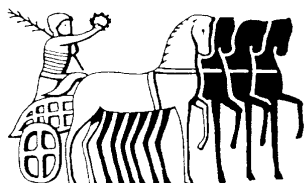

COLCHESTER ARCHAEOLOGICAL TRUST,  
Roman Circus House,  
Roman Circus Walk,  
Colchester,  
Essex, CO2 7GZ

*tel:* 01206 501785

*email:* [lp@catuk.org](mailto:lp@catuk.org)

## Site location and description

The development site is located on land to the east of the Constable Country Medical Centre, Heath Road, East Bergholt, Suffolk (Fig 1). Site centre is NGR TM 080 352.

## Proposed work

The development comprises a mixed-use development including up to 75 dwellings, a pre-school and a neighbourhood hub, comprising a swimming pool, office space and a local shop, public open space, and associated infrastructure and landscaping.

## Archaeological background

The following archaeological background draws on information from the Suffolk Historic Environment Record ([archaeology.her@suffolk.gov.uk](mailto:archaeology.her@suffolk.gov.uk)), SCC invoice number tbc:

### Geology

The Geology of Britain viewer (1:50,000 scale<sup>1</sup>) shows the bedrock geology of the site as Thames Group (clay, silty), with superficial deposits of Lowestoft Formation (sand and gravel).

### Historic landscape

Land to the east of the Constable Country Medieval Centre, Heath Road, East Bergholt is in an area defined as *plateau farmlands* in the Suffolk Landscape Character Assessment<sup>2</sup>. Within the Suffolk Historic Landscape Characterisation Map<sup>3</sup> it is defined as Landscape sub-type 10.3, built up area (village – substantial group of houses associated with a parish church). The landscape immediately around the development site is characterised as sub-type 1.1 (pre-18th-century enclosure – random fields); sub-type 1.4 (pre-18th century enclosure – irregular co-axial fields); sub-type 3.1 (post-1950 agricultural landscape (boundary loss from random fields); sub-type 5.1 (meadow or managed wetland –meadow); and sub-type 6.2 (horticulture – nurseries with glass houses).

There are no Heritage Assets within the proposed development site (PDS), but a list of all archaeological sites and finds within a 1km search area (radius) of the PDS can be found below (and on Fig 3). There are no listed battlefields, registered parks or gardens, or scheduled ancient monuments within the search area.

### Archaeology<sup>4</sup> (Fig 3)

Distances listed below have been measured from the centre of the PDS to the centre of the heritage asset.

**Roman:** Roman finds include a domed-lead spindlewhorl (EBG 005; 903m NNW).

**Late Saxon:** The historic settlement core of East Bergholt dates from the Late Saxon period (EBG 044, 580-1271m E/SE).

**Medieval/post-medieval:** Medieval/post-medieval features (three ditches and two undated postholes) and finds were identified during a geophysical survey (ESF23261), a metal-detecting survey (ESF23262) and trial-trenching evaluation (ESF23263) on land northwest of Moores Lane (EBG 048, 920m NW)

**Post-medieval:** Old Hall Park (EBG 045), located 1230m SW, is shown on early OS maps as a large area to the southeast of Old Hall (EBG 023) with numerous trees.

**Modern:** Two 19th century threshing barns are located at High Trees Farm (EBG 040, 680m NW)

<sup>1</sup> British Geological Survey – <http://mapapps.bgs.ac.uk/geologyofbritain/home.html?>

<sup>2</sup> <http://www.suffolklandscape.org.uk/>

<sup>3</sup> The Suffolk Historic Landscape Characterisation Map, version 3, 2008, Suffolk County Council

<sup>4</sup> This is based on records held at the Suffolk County Historic Environment Record (SCHER).



**Undated:** An undated cropmark complex of 'ice-wedges and linear marks forming former ? field system on different alignments to present system' is located 970m SE (EBG 013). An undated and disarticulated human skull was also recovered during road widening opposite the Carriers Arms (EBG 008, 670m WNW).

**Metal-detected finds:** There are 49 confidential findspots within the search area, although none were located within, or in particularly close proximity to the PDS. The finds date from the Neolithic to post-medieval periods. The Neolithic flints, mostly from the same location, include flint blades, scrapers and flakes. A few fragments of copper-alloy working waste have been assigned a possible Bronze Age date and there was a large rim sherd of an Iron Age carinated bowl. All further evidence from these findspots is medieval and post-medieval in origin, largely comprising metalwork such as coins, buttons, harness straps and mounts, and finger rings.

#### **Listed buildings<sup>5</sup> (Fig 3)**

There are 41 designated listed buildings within the search area of Grade II and II\* status dating from the 15th-19th centuries. None of these are in particularly close proximity to the PDS (the nearest being c 350m to the southeast) or will be affected by the proposed development in anyway.

#### **Desk-based assessment**

A desk-based assessment for the PDS was produced by Colchester Archaeological Trust in June 2016 (CAT Report 966). It summarised:

*Within the broader search area, the Suffolk Historic Environment Record (SHER) lists eight monuments. These include the findspots of a Roman spindle whorl and human skull of unknown date, a post-medieval timber framed pigeon loft and two 19th century threshing barns.*

*One area of cropmarks is located to near the edge of the search area, to the southeast of the PDS. These appear to be largely glacial, though possibly also include marks relating to a former field system. Two areas of East Bergholt are identified by the HER as being areas of historic activity – one is the historic settlement core of the village and the other is the area of parkland known as 'Old Hall Park'.*

*There has been one archaeological evaluation, near the edge of the search area, to the north-west of the PDS. Medieval and post-medieval finds and features were identified here during metal detecting and trial trenching.*

*As well as these listed monuments, 41 listed buildings and 49 confidential findspots are located within the search area. None of these are in close proximity to the PDS and any activity they indicate is unlikely to be affected by future development.*

#### **Geophysical survey (Fig 2)**

A detailed magnetometer survey was carried out over the PDS in October 2016 by Britannia Archaeology Ltd (Report Number: 1145). It summarised:

*The geophysical survey identified several anomalies that could be archaeological in origin. The features present within the survey are identified as low amplitude positive anomalies, which could be infilled ditch type features (1000 – 1002 and 1004), with anomalies 1001 and 1002 possibly representing an enclosure. A series of low amplitude anomalies (1003) on the northern boundary of the site have been identified as ploughing activity of an unknown date. A discrete high amplitude anomaly (1006) was identified of unknown origin, it is possible that the source of the anomaly is archaeological in origin.*

---

<sup>5</sup> This is based on records held at the Suffolk County Historic Environment Record (SCHER).

## Planning background

Planning applications were submitted to Babergh District Council in August 2016 (B/16/01092/OUT) for a mixed-use development including up to 75 dwellings, a pre-school and a neighbourhood hub, comprising a swimming pool, office space and a local shop, public open space, and associated infrastructure and landscaping.

As the site lies within an area highlighted by the Suffolk HER as having a high potential for archaeological deposits, an archaeological condition was recommended by the Suffolk County Council Archaeological Service Conservation Team (SCCAS/CT). The recommended archaeological condition is based on the condition based on the guidance given in the *National Planning Policy Framework* (DCLG 2012) and in this case in section 3 of the planning permission:

*" No development shall take place within the area indicated [the whole site] until the implementation of a programme of archaeological work has been secured, in accordance with a Written Scheme of Investigation which has been submitted to and approved in writing by the Local Planning Authority. The scheme of investigation shall include an assessment of significance and research questions."*

## Requirement for work (Fig 2)

The required archaeological work is for evaluation by trial-trenching. A Project Brief was not issued by the Suffolk County Council Archaeological Service/Conservation Team (SCCAS/CT) but the requirement for work was discussed with monitor Rachael Abraham in advance of the production of this wsi.

Specifically, trial-trenches will be excavated to cover 4% of the 8.2ha development site. This equates to sixty-one 30m trenches, each measuring 1.8m wide. Trenches will be laid out to sample all areas of the development site and to specifically target possible archaeological features identified by the geophysics (Fig 2).

Decisions on the need for any further archaeological investigation (eg excavation) will be made by SCCAS/CT, in a further brief, based on the results presented in the evaluation report. Any further investigation will also be the subject of a further WSI, submitted to SCCAS/CT for scrutiny and formally approved by the LPA.

## Aims

As per section 4 of the brief a linear trenched evaluation is required on the development site to enable the archaeological resource, both in quality and extent, to be accurately quantified.

Trial-trenching is required to:

- identify the date, approximate form and purpose of any archaeological deposit, together with its likely extent, localised depth and quality of preservation.
- evaluate the likely impact of past land uses, and the possible presence of masking colluvial/alluvial deposits.
- establish the potential for the survival of environmental evidence
- provide sufficient information to construct an archaeological conservation strategy, dealing with preservation, the recording of archaeological deposits, working practices, timetables and orders of costs.

All work will take place within and contribute to the goals of the Regional research frameworks (Gurney 2003, Medlycott 2011).

## Staffing

The number of field staff for this project is estimated as follows: one supervisor plus one surveyor and five archaeologists for thirteen days.

In charge of day-to-day site work: Ben Holloway

## General methodology

All work carried out by CAT will be in accordance with:

- professional standards of the Chartered Institute for Archaeologists, including its *Code of Conduct* (CIfA 2008a, b)
- Standards and Frameworks published by East Anglian Archaeology (Gurney 2003, Medlycott 2011)
- relevant Health & Safety guidelines and requirements (CAT 2014)
- The outline specification within *Requirements for a Trenched Archaeological Evaluation* (SCCAS 2017a).

Professional CAT field archaeologists will undertake all specified archaeological work, for which they will be suitably experienced and qualified.

Notification of the supervisor/project manager's name and the start date for the project will be provided to SCCAS/CT one week before start of work.

Unless it is the responsibility of other site contractors, CAT will study mains service locations and avoid damage to these.

Prior to the commencement of the site a parish code and event number will be sought from the HER team. This code will be used to identify the finds bags and boxes, and the project archive when it is deposited at the curating museum.

At the start of work (immediately before fieldwork commences) an OASIS online record <http://ads.ahds.ac.uk/project/oasis/> will be initiated and key fields completed on Details, Location and Creators forms. At the end of the project all parts of the OASIS online form will be completed for submission to SCCAS. This will include an uploaded .PDF version of the entire report.

## Evaluation trial-trenching methodology

Where appropriate, modern overburden and any topsoil stripping/levelling will be performed using a mechanical excavator equipped with a toothless ditching bucket under the supervision and to the satisfaction of a professional archaeologist. If no archaeologically significant deposits are exposed, machine excavation will continue until natural subsoil is reached.

Where necessary, areas will be cleaned by hand to ensure the visibility of archaeological deposits.

If archaeological features or deposits are uncovered, time will be allowed for these to be excavated, planned and recorded.

There will be sufficient excavation to give clear evidence for the period, depth and nature of any archaeological deposit. For linear features 1m wide sections will be excavated across their width to a total of 10% of the overall length. Discrete features, such as pits, will have 50% of their fills excavated, although certain features may be fully excavated. The depth and nature of colluvial or other masking deposits will be established across the site.

Complex archaeological structures such as walls, kilns, or ovens will be sufficiently defined for recording, but will not be removed.

Fast hand-excavation techniques involving (for instance) picks, forks and mattocks will not be used on complex stratigraphy.

Trained CAT staff (Ben Holloway and Harvey Furniss) will use a metal detector to scan all trenches both before and during excavation. The metal detector will **not** be set to discriminate against iron and all metal finds will have their positions plotted by GPS or with the Total Station. All spoil heaps will also be scanned and finds recovered.

Individual records of excavated contexts, layers, features or deposits will be entered on pro-forma record sheets. Registers will be compiled of finds, small finds and soil samples.

The photographic record will consist of general site shots, and shots of all archaeological features and deposits. A photographic scale (including north arrow) shall be included in the case of detailed photographs. Standard "record" shots of contexts will be taken on a digital camera. A photographic register will accompany the photographic record. This will detail as a minimum feature number, location, and direction of shot.

Trenches will not be backfilled until they have been signed off by the SCCAS/CT.

### **Site surveying**

The evaluation trench and any features will be surveyed by Total Station, unless the particulars of the features indicate that manual planning techniques should be employed. Normal scale for archaeological site plans and sections is 1:20 and 1:10 respectively, unless circumstances indicate that other scales would be more appropriate.

The site grid will be tied into the National Grid. Corners of excavation areas will be located by NGR coordinates.

### **Environmental sampling policy**

The number and range of samples collected will be adequate to determine the potential of the site, with particular focus on palaeoenvironmental remains including both biological remains (e.g. plants, small vertebrates) and small sized artefacts (e.g. smithing debris), and to provide information for sampling strategies on any future excavation. Samples will be collected for potential micromorphical and other pedological sedimentological analysis. Environmental bulk samples will be 40 litres in size (assuming context is large enough)

Sampling strategies will address questions of:

- the range of preservation types (charred, mineral-replaced, waterlogged), and their quality
- concentrations of macro-remains
- and differences in remains from undated and dated features
- variation between different feature types and areas of site

CAT has an arrangement with Val Fryer/Lisa Gray whereby any potentially rich environmental layers or features will be appropriately sampled as a matter of course. Trained CAT staff will process the samples (unless complex or otherwise needing specialist processing) and the flots will be sent to VF/LG for reporting.

Should any complex, or otherwise outstanding deposits be encountered, VF/LG will be asked onto site to advise. Waterlogged 'organic' features will always be sampled. In all cases, the advice of VF/LG and/or the Historic England Regional Advisor in Archaeological Science (East of England) on sampling strategies for complex or waterlogged deposits will be followed, including the taking of monolith samples.

### **Human remains**

CAT follows the policy of leaving human remains *in situ* unless there is a clear indication that the remains are in danger of being compromised as a result of their exposure. If circumstances indicated it were prudent or necessary to remove remains from the site during the monitoring, the following criteria would be applied; if it is clear from their position, context, depth, or other factors that the remains are ancient, then normal procedure is to apply to the Department of Justice for a licence to remove them. In that case, conditions laid down by the license will be followed. If it seems that the remains are not ancient, then the coroner, the client, and SCCAS/CT will be informed, and any advice and/or instruction from the coroner will be followed.

## Photographic record

The photographic record will consist of general site shots, and shots of all archaeological features and deposits. A photographic scale (including north arrow) shall be included in the case of detailed photographs. Standard "record" shots of contexts will be taken on a digital camera. A photographic register will accompany the photographic record. This will detail as a minimum feature number, location, and direction of shot.

## Post-excavation assessment

If a post-excavation assessment is required by SCCAS/CT, it will be normally be submitted within 2 months of the end of fieldwork, or as quickly as is reasonably practicable and at a time agreed with SCCAS/CT.

Where archaeological results do not warrant a post-excavation assessment, preparation of the normal site report will begin.

## Finds

All significant finds will be retained.

All finds, where appropriate, will be washed and marked with site code and context number.

Stephen Benfield (CAT) normally writes our finds reports. Some categories of finds are automatically referred to other CAT specialists:

animal bones (small groups): Pip Parmenter

small finds, metalwork, coins, etc: Pip Parmenter / Laura Pooley

flints: Adam Wightman

or to outside specialists:

animal bones (large groups) and human remains: Julie Curl (*Sylvanus*)

environmental processing and reporting: Val Fryer / Lisa Gray

conservation of finds: staff at Colchester Museum / Laura Ratcliffe (LR Conservation)

Other specialists whose opinion can be sought on large or complex groups include:

Roman brick/tile: Ernest Black

Roman glass: Hilary Cool

Prehistoric pottery: Paul Sealey

Other: EH Regional Adviser in Archaeological Science (East of England).

All finds of potential treasure will be removed to a safe place, and reported immediately to the Suffolk FLO (Finds Liaison Office) who will inform the coroner within 14 days, in accordance with the rules of the Treasure Act 1996. The definition of treasure is given in pages 3-5 of the Code of Practice of the above act. This refers primarily to gold or silver objects.

Requirements for conservation and storage of finds will be agreed with SCCAS and carried out as per their guidelines (SCCAS 2017b).

## Results

Notification will be given to SCCAS/CT when the fieldwork has been completed.

An appropriate archive will be prepared to minimum acceptable standards outlined in *Management of Research Projects in the Historic Environment* (English Heritage 2006).

The draft report will be submitted within 6 months of the end of fieldwork for approval by SCCAS/CT.

Final report will normally be submitted to SCCAS/CT as both a PDF and a hard copy.

The report will contain:

- The aims and methods adopted in the course of the archaeological project

- Location plan of the area in relation to the proposed development.
- Section/s drawings showing depth of deposits from present ground level with Ordnance Datum, vertical and horizontal scale.
- Archaeological methodology and detailed results including a suitable conclusion and discussion and results referring to Regional Research Frameworks (EAA8, EAA14 & EAA24).
- All specialist reports or assessments
- A concise non-technical summary of the project results
- Appendices to include a copy of the completed OASIS summary sheet and the approved WSI

Results will be published, to at least a summary level, in the PSIAH (Proceedings of the Suffolk Institute of Archaeology and History) annual round up should archaeological remains be encountered in the evaluation. An allowance will be made for this in the project costs for the report.

Final reports are also published on the CAT website and on the OASIS website.

### **Archive deposition**

The archive will be deposited with the Suffolk County Council Archaeological Service as per their archive guidelines (SCCAS 2017b).

If the finds are to remain with the landowner, a full copy of the archive will be housed with the SCCAS.

The archive will be deposited with the SCCAS within 3 months of the completion of the final publication report, with a summary of the contents of the archive supplied to SCCAS/CT.

### **Monitoring**

SCCAS/CT will be responsible for monitoring progress and standards throughout the project, and will be kept regularly informed during fieldwork, post-excavation and publication stages.

Notification of the start of work will be given SCCAS/CT one week in advance of its commencement.

Any variations in this WSI will be agreed with SCCAS/CT prior to them being carried out.

SCCAS/CT will be notified when the fieldwork is complete. Trenches will not be backfilled until they have been signed off by the SCCAS/CT.

The involvement of SCCAS/CT shall be acknowledged in any report or publication generated by this project.

### **Education and outreach**

The CAT website ([www.thecolchesterarchaeologist.co.uk](http://www.thecolchesterarchaeologist.co.uk)) is updated regularly with information on current sites. Copies of our reports (grey literature) can be viewed on the website and downloaded for free. A magazine (*The Colchester Archaeologist Vol 28* out now) summarises all our sites and staff regularly give lectures to groups, societies and schools (a fee may apply). CAT also works alongside the Colchester Archaeological Group (providing a venue for their lectures and library) and the local Young Archaeologists Club.

CAT archaeologists can be booked for lectures and information on fees can be obtained by contacting the office on 01206 501785.

### **References**

- |                              |      |   |
|------------------------------|------|---|
| Britannia Archaeology Ltd    | 2016 | <i>Land east of the Constable Medical Centre, Heath Road, East Bergholt: Detailed Magnetometer Survey. Report Number 1145: October 2016</i>                     |
| Brown, N and Glazenbrook, J. | 2000 | <i>Research and Archaeology: a frame work for the Eastern Counties 2 Research agenda and strategy, East Anglian Archaeological, occasional papers 8 (EAA 8)</i> |



CAT	2014	<i>Health &amp; Safety Policy</i>
CAT Report 966	2016	<i>A desk-based assessment of the archaeological remains on and around land at Heath Road, East Bergholt.</i>
CIfA	2008a	<i>Standard and Guidance for an archaeological evaluation</i>
CIfA	2008b	<i>Standard and guidance for the collection, documentation, conservation and research of archaeological materials</i>
DCLG	2012	<i>National Planning Policy Framework</i>
Gurney, D	2003	<i>Standards for field archaeology in the East of England. East Anglian Archaeology Occasional Papers 14 (EAA 14).</i>
English Heritage	2006	<i>Management of Research Projects in the Historic Environment (MoRPHE)</i>
Medlycott, M	2011	<i>Research and archaeology revisited: A revised framework for the East of England. East Anglian Archaeology Occasional Papers 24 (EAA 24)</i>
SCC	2008	<i>The Suffolk Historic Landscape Characterisation Map, version 3</i>
SCCAS	2017a	<i>Requirements for a Trenched Archaeological Evaluation (version 1.3)</i>
SCCAS	2017b	<i>Archaeological Archives in Suffolk: Guidelines for preparation and deposition</i>

L Pooley



Colchester Archaeological Trust,  
Roman Circus House,  
Roman Circus Walk,  
Colchester,  
Essex, CO2 7GZ

tel: 01206 501785  
email: [lp@catuk.org](mailto:lp@catuk.org)

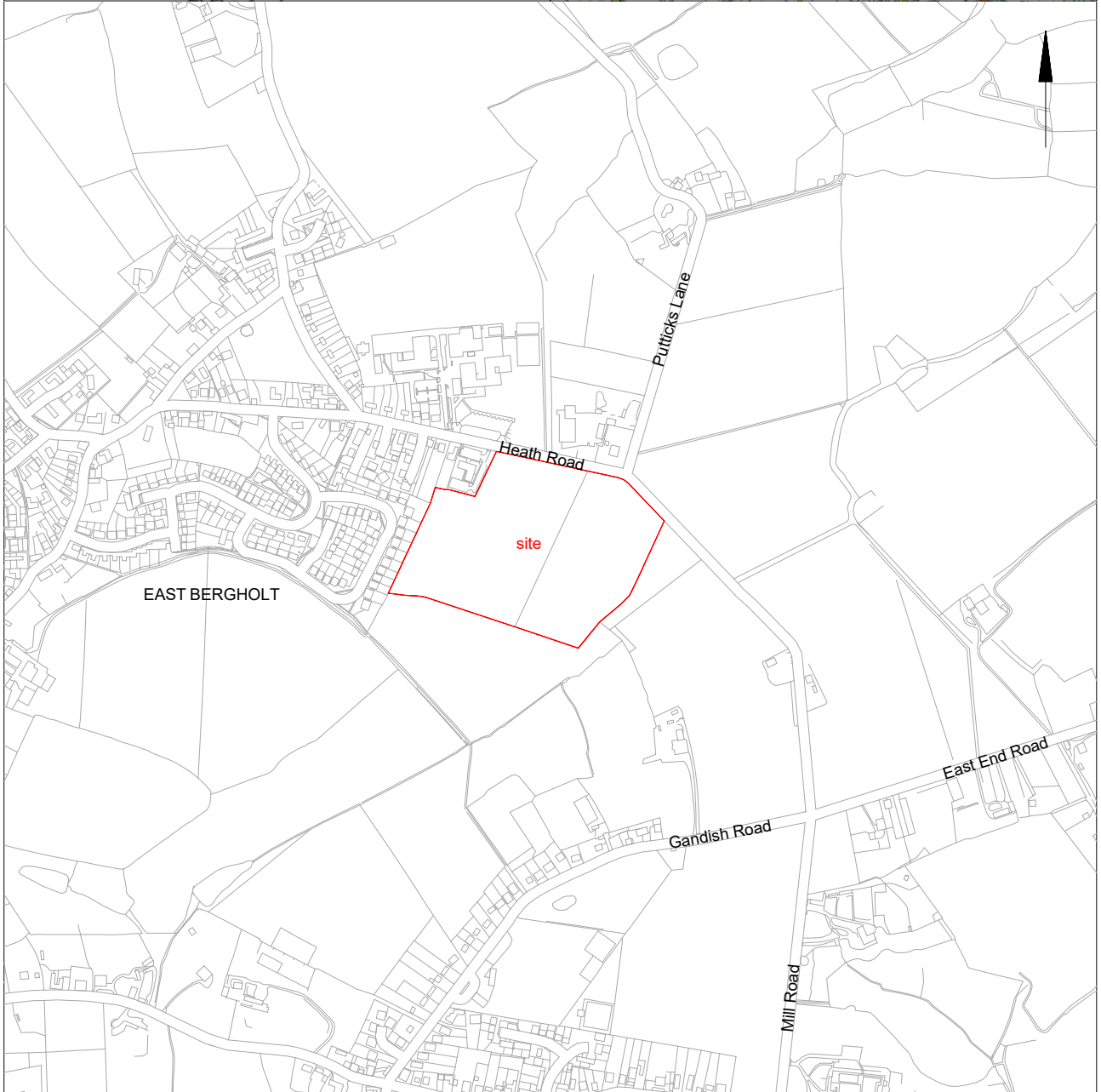
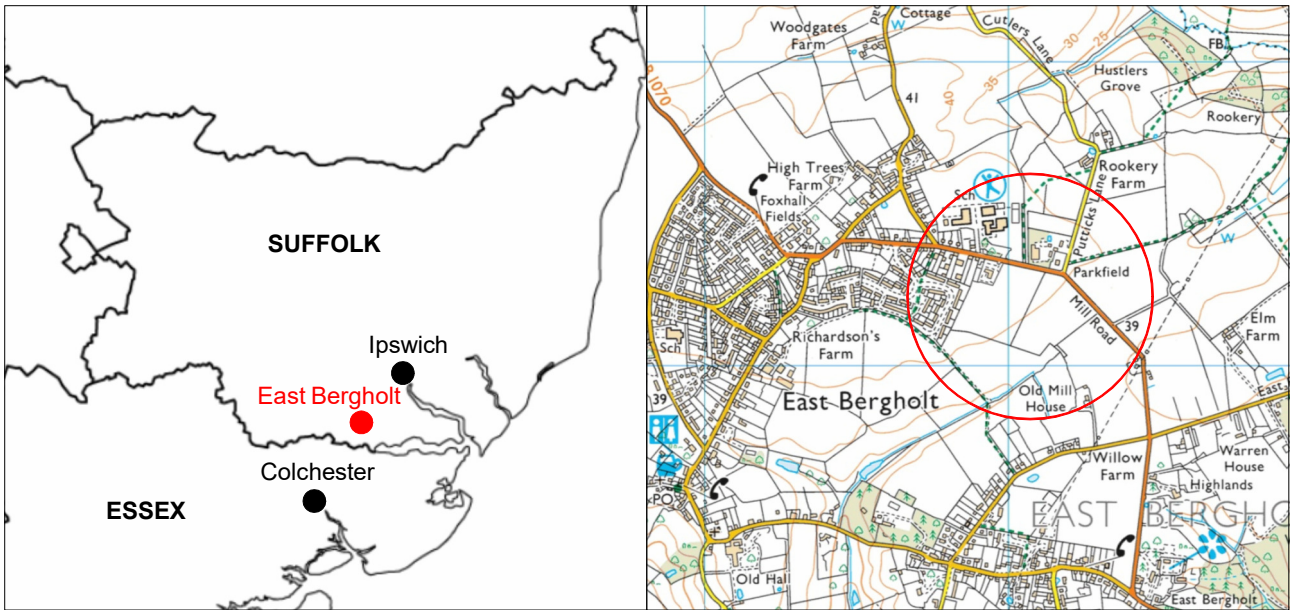

© Crown copyright. All rights reserved. Licence number 100039294.

Fig 1 Site location.



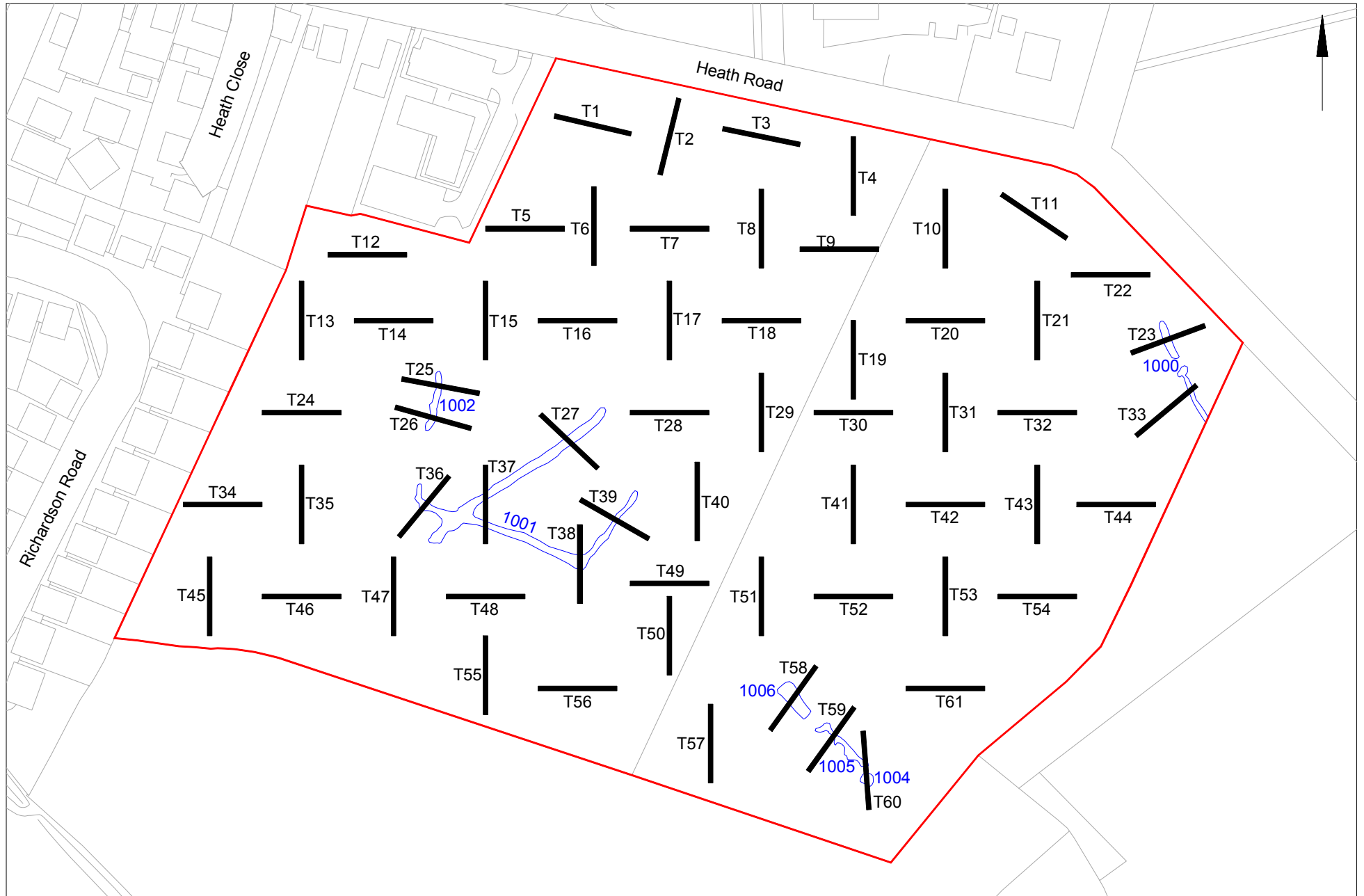

© Crown copyright. All rights reserved. Licence number 100039294.

Fig 2 Trench proposal. Geophysical anomalies marked in blue (numbers as Britannia Archaeology Ltd Report Number 1145).







© Crown copyright. All rights reserved. Licence number 100039294.  
 Imagery ©2017 Google, Getmapping plc, Infoterra Ltd & Bluesky, Map data ©2017 Google.

Fig 3 HER data (green) and listed buildings (blue) in relation to the development site (marked red).



# OASIS DATA COLLECTION FORM: England

[List of Projects](#) | [Manage Projects](#) | [Search Projects](#) | [New project](#) | [Change your details](#) | [HER coverage](#) | [Change country](#) | [Log out](#)

## Printable version

**OASIS ID: colchest3-292177**

### Project details

Project name	Archaeological evaluation on land east of Constable Medical Centre, Heath Road, East Bergholt, Suffolk, CO7 6RT
Short description of the project	An archaeological evaluation (sixty-one trial-trenches) was carried out on land to the east of Constable Country Medical Centre, Heath Road, East Bergholt, Suffolk in advance of the construction of a mixed-use development including up to seventy-five dwellings, a pre-school and a neighbourhood hub, associated infrastructure and landscaping. The evaluation followed a desk-based assessment and geophysical survey of the site. Twenty-eight features - either undated or originating from the post-medieval or modern periods - were uncovered, some of which represent the remains of a former field boundary detailed in historic mapping of the area.
Project dates	Start: 14-08-2017 End: 25-08-2017
Previous/future work	Yes / Not known
Any associated project reference codes	17/08h - Contracting Unit No.
Any associated project reference codes	B/16/01092/OUT - Planning Application No.
Any associated project reference codes	EBG 060 - Museum accession ID
Any associated project reference codes	ESF25709 - HER event no.
Type of project	Field evaluation
Site status	None
Current Land use	Cultivated Land 4 - Character Undetermined
Monument type	PIT Uncertain
Monument type	POSTHOLE Uncertain
Monument type	DITCH Post Medieval
Monument type	DITCH Modern
Monument type	SILT PATCH Modern

Monument type	PIT Modern
Monument type	KILN Modern
Monument type	PIT Post Medieval
Monument type	PIT Uncertain
Monument type	LAND DRAIN Post Medieval
Monument type	LAND DRAIN Modern
Monument type	NATURAL FEATURE Uncertain
Monument type	DITCH Uncertain
Significant Finds	BURNT STONE Uncertain
Significant Finds	CHARCOAL Uncertain
Significant Finds	POTTERY Modern
Significant Finds	TOBACCO PIPE Modern
Significant Finds	CBM Modern
Significant Finds	POTTERY Post Medieval
Significant Finds	GLASS Post Medieval
Significant Finds	CBM Post Medieval
Significant Finds	ANIMAL BONE Post Medieval
Significant Finds	ANIMAL BONE Modern
Significant Finds	METAL OBJECT Post Medieval
Significant Finds	METAL OBJECT Modern
Significant Finds	FLINT Late Prehistoric
Significant Finds	POTTERY Medieval
Significant Finds	HONE Uncertain
Methods & techniques	""Sample Trenches"", ""Targeted Trenches""
Development type	Rural residential
Prompt	Planning condition
Position in the planning process	After outline determination (eg. As a reserved matter)

### Project location

Country	England
Site location	SUFFOLK BABERGH EAST BERGHOLT land east of Constable Country Medical Centre, Heath Road
Postcode	CO7 6RT
Study area	8.2 Hectares
Site coordinates	TM 080 352 51.975743139816 1.028840556429 51 58 32 N 001 01 43 E Point
Height OD / Depth	Min: 35.27m Max: 38.74m

### Project creators

Name of Organisation	Colchester Archaeological Trust
Project brief originator	none
	Laura Pooley



Project design originator	
Project director/manager	Chris Lister
Project supervisor	Nigel Rayner
Type of sponsor/funding body	Developer

### Project archives

Physical Archive Exists?	No
Digital Archive recipient	Suffolk County Council Archaeology Service
Digital Archive ID	EBG 060
Digital Media available	"Images raster / digital photography","Survey"
Paper Archive recipient	Suffolk County Council Archaeology Service
Paper Archive ID	EBG 060
Paper Media available	"Context sheet","Drawing","Miscellaneous Material","Photograph","Report"

### Project bibliography 1

Publication type	Grey literature (unpublished document/manuscript)
Title	Archaeological evaluation on land east of the Constable Country Medical centre, Heath Road, East Bergholt, Suffolk, IP9 2LX: August 2017
Author(s)/Editor(s)	Hicks, E.
Other bibliographic details	CAT Report 1164
Date	2017
Issuer or publisher	Colchester Archaeological Trust
Place of issue or publication	Colchester
Description	A4 loose-leaf ringbound
URL	<a href="http://cat.essex.ac.uk/">http://cat.essex.ac.uk/</a>
Entered by	Elliott Hicks (lp@catuk.org)
Entered on	12 October 2017

**OASIS:**

Please e-mail [Historic England](#) for OASIS help and advice

© ADS 1996-2012 Created by [Jo Gilham and Jen Mitcham](#), [email](#) Last modified Wednesday 9 May 2012

Cite only: <http://www.oasis.ac.uk/form/print.cfm?id=298153> for this page